

C2012NP02W472J125AA

TDK Item Description : C2012NP02W472JT****



Application & Main Feature

Commercial Grade (High Temperature Application)

Series

C2012 [EIA 0805]

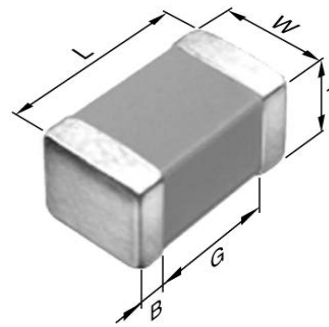

Dimensions

L	2.00mm ±0.20mm
W	1.25mm ±0.20mm
T	1.25mm ±0.20mm
B	0.20mm Min.
G	0.50mm Min.

Temperature Characteristic

NP0 (-55 to 150 degC 0+/-30ppm/degC)

Rated Voltage

2W(450Vdc)

Capacitance

4.7nF

Capacitance Tolerance

J (±5%)

Q Factor

1000 Min.

Insulation Resistance

10Gohm Min

AEC-Q200

Not Applicable

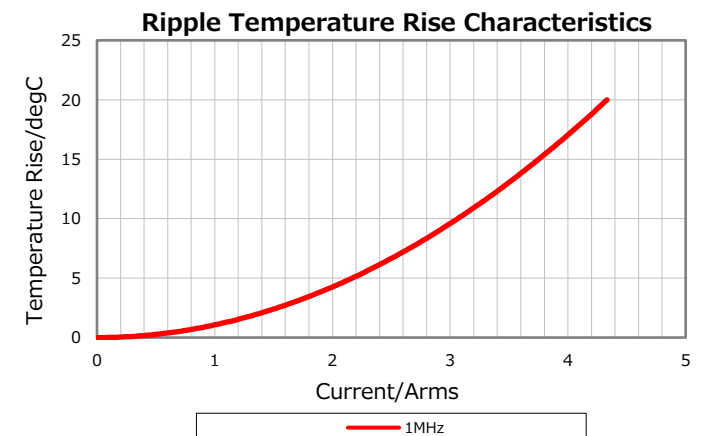
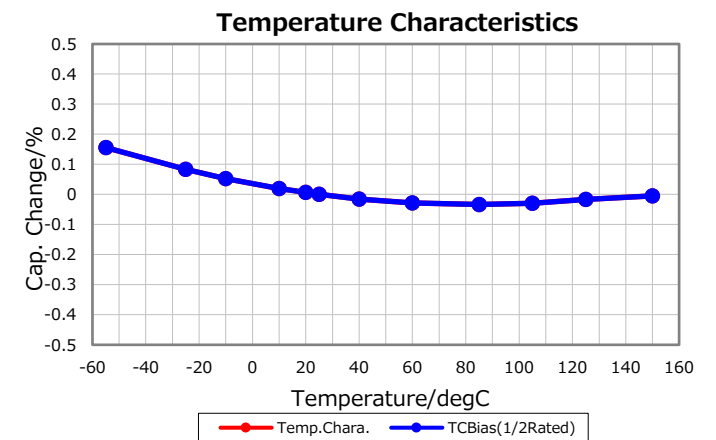
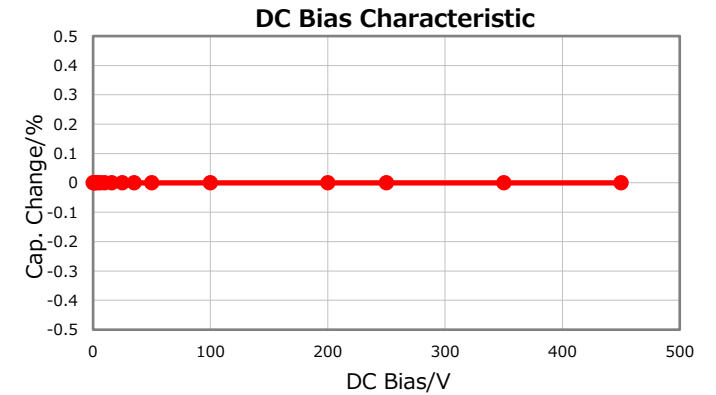
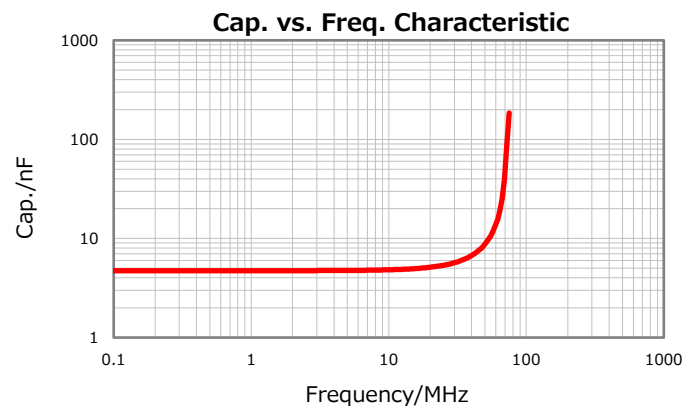
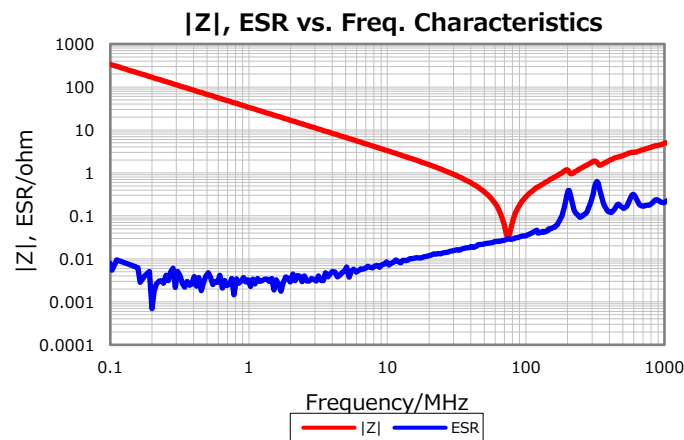

Characterization Sheet (Multilayer Ceramic Chip Capacitors)



All specifications are subject to change without notice.

July 2, 2019