

General Description

- Trench Power AlphaMOS-II technology
- Low $R_{DS(ON)}$
- Low C_{iss} and C_{rss}
- High Current Capability
- RoHS and Halogen Free Compliant

Applications

- General Lighting for LED and CCFL
- AC/DC Power supplies for Industrial, Consumer, and Telecom

Product Summary

$V_{DS} @ T_{j,max}$	700V
I_{DM}	40A
$R_{DS(ON),max}$	< 0.7 Ω
$Q_{g,typ}$	26nC
$E_{oss} @ 400V$	3.5 μ J

100% UIS Tested
 100% R_g Tested

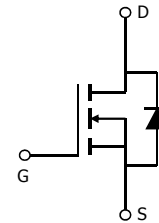
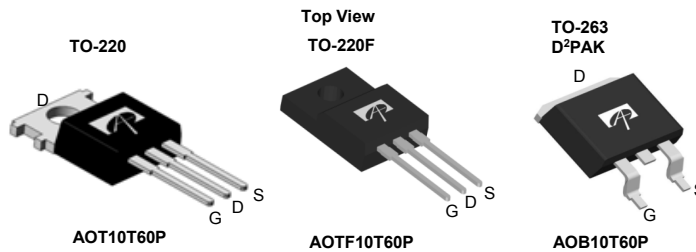

Orderable Part Number	Package Type	Form	Minimum Order Quantity
AOT10T60PL	TO-220 Green	Tube	1000
AOB10T60PL	TO-263 Green	Tape & Reel	800
AOTF10T60P	TO-220F Pb Free	Tube	1000
AOTF10T60PL	TO-220F Green	Tube	1000

Absolute Maximum Ratings $T_A=25^\circ\text{C}$ unless otherwise noted

Parameter	Symbol	AOT(B)10T60P	AOTF10T60P	AOTF10T60PL	Units
Drain-Source Voltage	V_{DS}		600		V
Gate-Source Voltage	V_{GS}		± 30		V
Continuous Drain Current	I_D	$T_C=25^\circ\text{C}$	10	10*	10*
		$T_C=100^\circ\text{C}$	6.6	6.6*	6.6*
Pulsed Drain Current ^C	I_{DM}		40		A
Avalanche Current ^C $L=1\text{mH}$	I_{AR}		10		A
Repetitive avalanche energy ^C	E_{AR}		50		mJ
Single pulsed avalanche energy ^G	E_{AS}		480		mJ
MOSFET dv/dt ruggedness	dv/dt		50		V/ns
Peak diode recovery dv/dt ^J			15		
Power Dissipation ^B	P_D	$T_C=25^\circ\text{C}$	208	43	33
		Derate above 25°C	1.7	0.3	0.26
Junction and Storage Temperature Range	T_J, T_{STG}		-55 to 150		$^\circ\text{C}$
Maximum lead temperature for soldering purpose, 1/8" from case for 5 seconds	T_L		300		$^\circ\text{C}$

Thermal Characteristics

Parameter	Symbol	AOT(B)10T60P	AOTF10T60P	AOTF10T60PL	Units
Maximum Junction-to-Ambient ^{A,D}	$R_{\theta JA}$	65	65	65	$^\circ\text{C/W}$
Maximum Case-to-sink ^A	$R_{\theta CS}$	0.5	--	--	$^\circ\text{C/W}$
Maximum Junction-to-Case	$R_{\theta JC}$	0.6	2.9	3.8	$^\circ\text{C/W}$

* Drain current limited by maximum junction temperature.

Electrical Characteristics (T_J=25°C unless otherwise noted)

Symbol	Parameter	Conditions	Min	Typ	Max	Units
STATIC PARAMETERS						
BV _{DSS}	Drain-Source Breakdown Voltage	I _D =250μA, V _{GS} =0V, T _J =25°C	600			V
		I _D =250μA, V _{GS} =0V, T _J =150°C		700		
BV _{DSS} /ΔT _J	Breakdown Voltage Temperature Coefficient	I _D =250μA, V _{GS} =0V		0.56		V/°C
I _{DSS}	Zero Gate Voltage Drain Current	V _{DS} =600V, V _{GS} =0V			1	μA
		V _{DS} =480V, T _J =125°C			10	
I _{GSS}	Gate-Body leakage current	V _{DS} =0V, V _{GS} =±30V			±100	nA
V _{GS(th)}	Gate Threshold Voltage	V _{DS} =5V, I _D =250μA	3	4.3	5	V
R _{DS(ON)}	Static Drain-Source On-Resistance	V _{GS} =10V, I _D =5A		0.58	0.7	Ω
g _{FS}	Forward Transconductance	V _{DS} =40V, I _D =5A		8.8		S
V _{SD}	Diode Forward Voltage	I _S =1A, V _{GS} =0V		0.74	1	V
I _S	Maximum Body-Diode Continuous Current				10	A
I _{SM}	Maximum Body-Diode Pulsed Current ^C				40	A
DYNAMIC PARAMETERS						
C _{iss}	Input Capacitance	V _{GS} =0V, V _{DS} =100V, f=1MHz		1595		pF
C _{oss}	Output Capacitance				56	
C _{o(er)}	Effective output capacitance, energy related ^H	V _{GS} =0V, V _{DS} =0 to 480V, f=1MHz		42		pF
C _{o(tr)}	Effective output capacitance, time related ^I				74	
C _{rss}	Reverse Transfer Capacitance	V _{GS} =0V, V _{DS} =100V, f=1MHz		11		pF
R _g	Gate resistance	f=1MHz		1.7		Ω
SWITCHING PARAMETERS						
Q _g	Total Gate Charge	V _{GS} =10V, V _{DS} =480V, I _D =10A		26	40	nC
Q _{gs}	Gate Source Charge			8.1		nC
Q _{gd}	Gate Drain Charge			8.2		nC
t _{D(on)}	Turn-On DelayTime	V _{GS} =10V, V _{DS} =300V, I _D =10A, R _G =25Ω		42		ns
t _r	Turn-On Rise Time			54		ns
t _{D(off)}	Turn-Off DelayTime			52		ns
t _f	Turn-Off Fall Time			24		ns
t _{rr}	Body Diode Reverse Recovery Time	I _F =10A, di/dt=100A/μs, V _{DS} =100V		497		ns
Q _{rr}	Body Diode Reverse Recovery Charge	I _F =10A, di/dt=100A/μs, V _{DS} =100V		7.3		μC

A. The value of R_{θJA} is measured with the device in a still air environment with T_A=25°C.

B. The power dissipation P_D is based on T_{J(MAX)}=150°C, using junction-to-case thermal resistance, and is more useful in setting the upper dissipation limit for cases where additional heatsinking is used.

C. Repetitive rating, pulse width limited by junction temperature T_{J(MAX)}=150°C. Ratings are based on low frequency and duty cycles to keep initial T_J=25°C.

D. The R_{θJA} is the sum of the thermal impedance from junction to case R_{θJC} and case to ambient.

E. The static characteristics in Figures 1 to 6 are obtained using <300 ms pulses, duty cycle 0.5% max.

F. These curves are based on the junction-to-case thermal impedance which is measured with the device mounted to a large heatsink, assuming a maximum junction temperature of T_{J(MAX)}=150°C. The SOA curve provides a single pulse rating.

G. L=60mH, I_{AS}=4A, V_{DD}=150V, R_G=25Ω, Starting T_J=25°C.

H. C_{o(er)} is a fixed capacitance that gives the same stored energy as C_{oss} while V_{DS} is rising from 0 to 80% V_{(BR)DSS}.

I. C_{o(tr)} is a fixed capacitance that gives the same charging time as C_{oss} while V_{DS} is rising from 0 to 80% V_{(BR)DSS}.

J. I_{SD}≤I_D, di/dt≤200A/μs, V_{DD}=400V, T_J≤T_{J(MAX)}.

THIS PRODUCT HAS BEEN DESIGNED AND QUALIFIED FOR THE CONSUMER MARKET. APPLICATIONS OR USES AS CRITICAL COMPONENTS IN LIFE SUPPORT DEVICES OR SYSTEMS ARE NOT AUTHORIZED. AOS DOES NOT ASSUME ANY LIABILITY ARISING OUT OF SUCH APPLICATIONS OR USES OF ITS PRODUCTS. AOS RESERVES THE RIGHT TO IMPROVE PRODUCT DESIGN, FUNCTIONS AND RELIABILITY WITHOUT NOTICE.

TYPICAL ELECTRICAL AND THERMAL CHARACTERISTICS

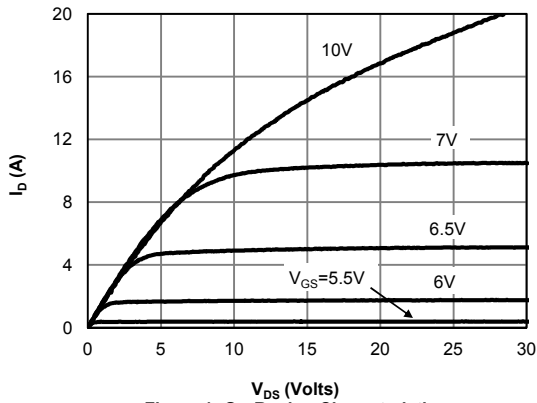

Figure 1: On-Region Characteristics

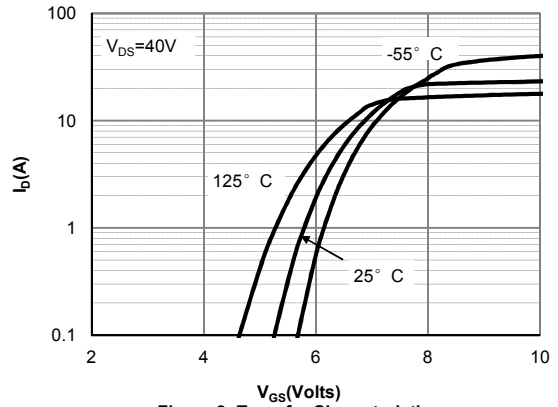

Figure 2: Transfer Characteristics

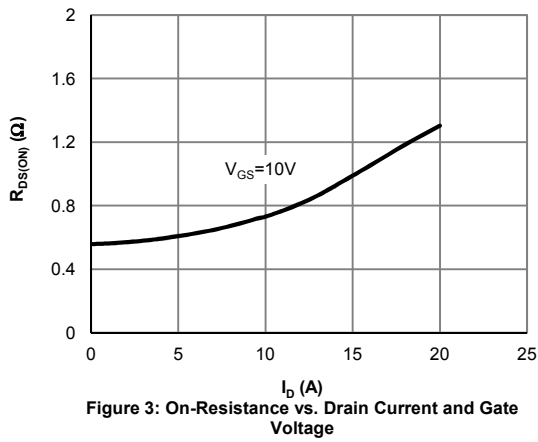

Figure 3: On-Resistance vs. Drain Current and Gate Voltage

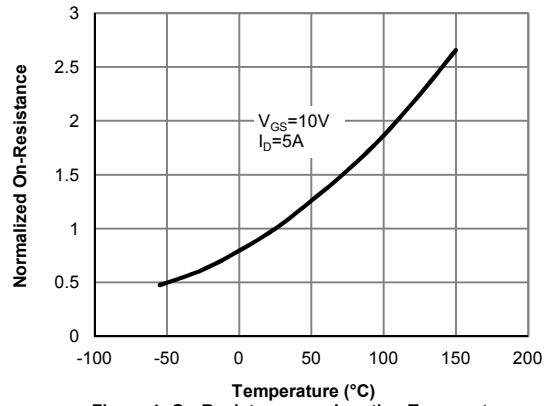

Figure 4: On-Resistance vs. Junction Temperature

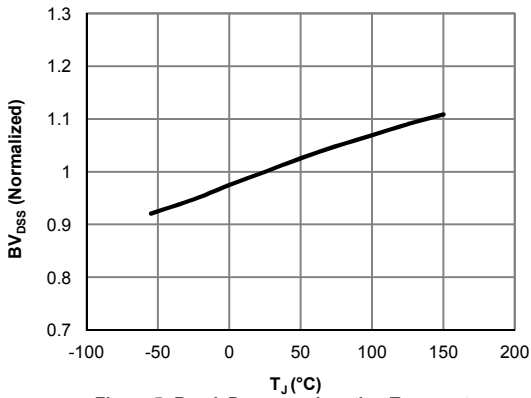

Figure 5: Break Down vs. Junction Temperature

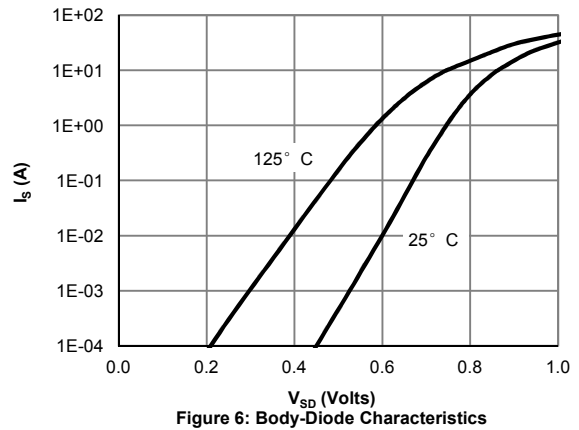
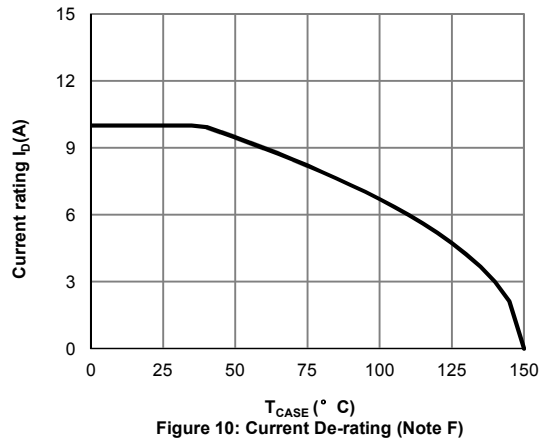
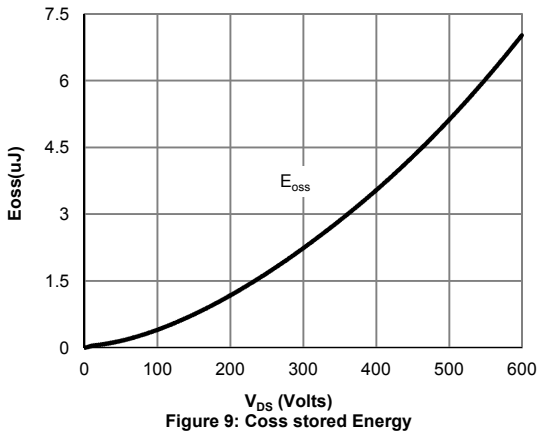
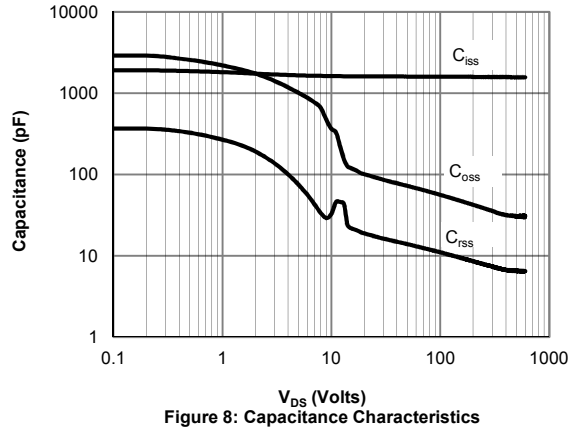
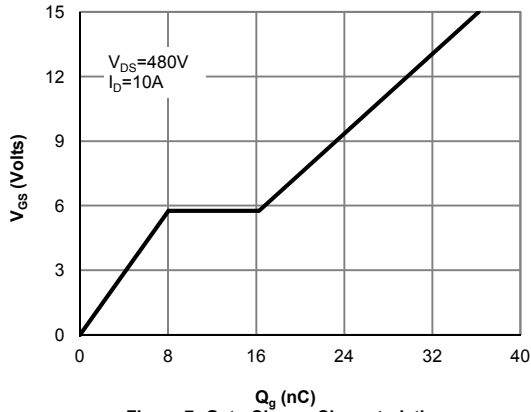

Figure 6: Body-Diode Characteristics

TYPICAL ELECTRICAL AND THERMAL CHARACTERISTICS



TYPICAL ELECTRICAL AND THERMAL CHARACTERISTICS

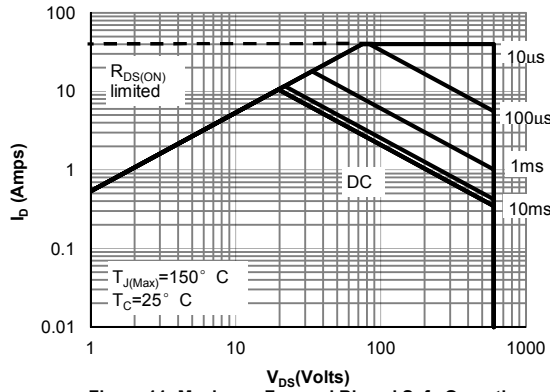

Figure 11: Maximum Forward Biased Safe Operating Area for TO-220/TO-263 (Note F)

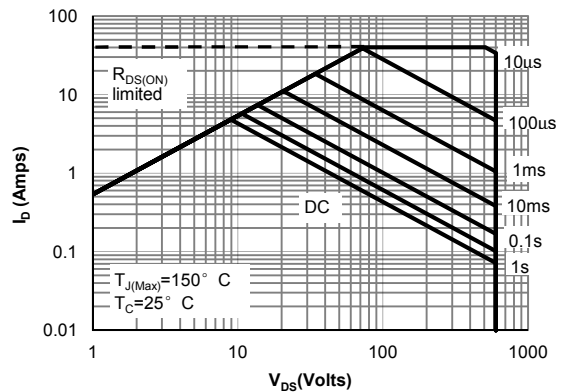

Figure 12: Maximum Forward Biased Safe Operating Area for TO-220F Pb Free (Note F)

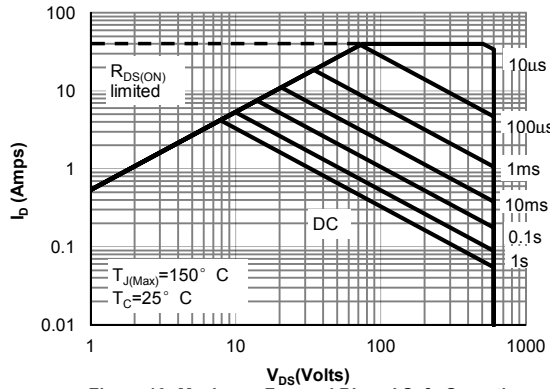

Figure 13: Maximum Forward Biased Safe Operating Area for TO-220F Green (Note F)

TYPICAL ELECTRICAL AND THERMAL CHARACTERISTICS

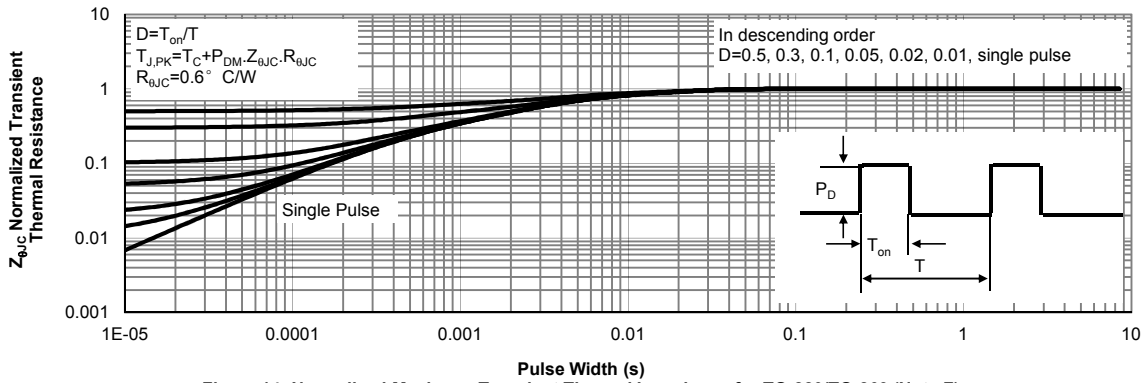

Figure 14: Normalized Maximum Transient Thermal Impedance for TO-220/TO-263 (Note F)

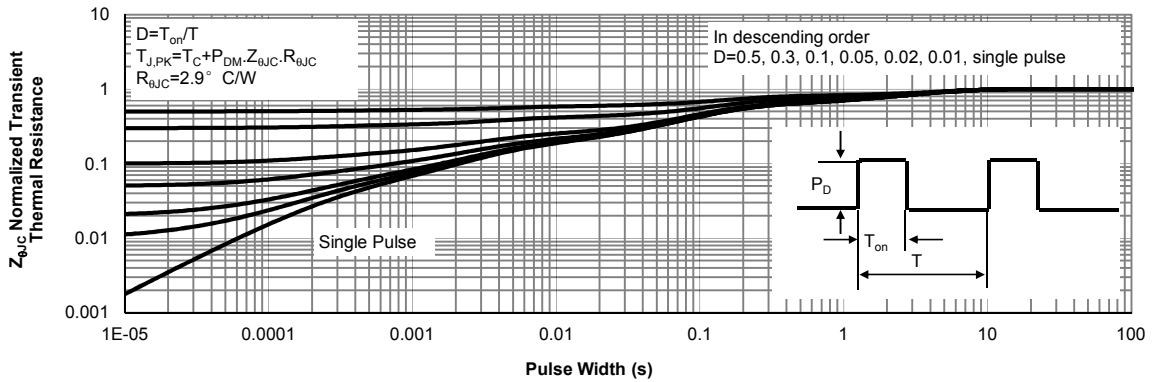

Figure 15: Normalized Maximum Transient Thermal Impedance for TO-220F Pb Free (Note F)

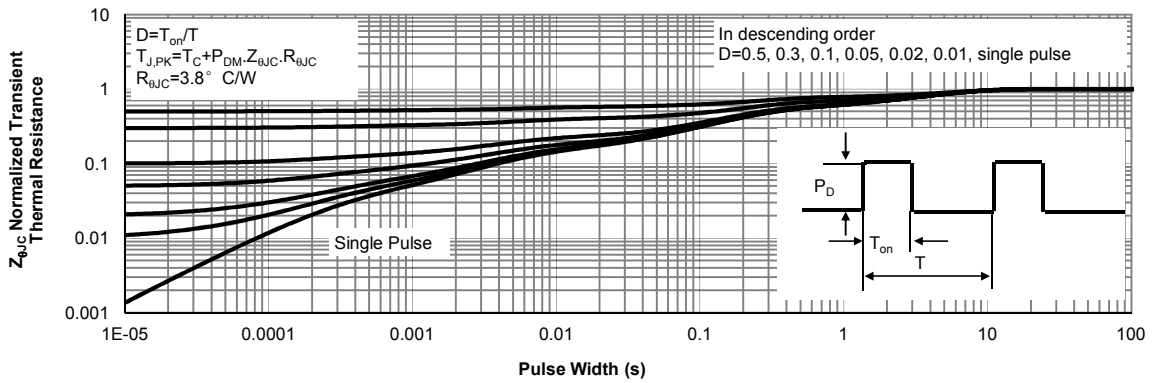
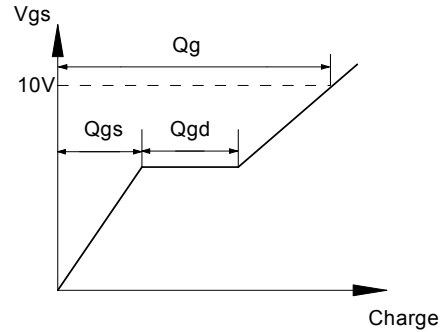
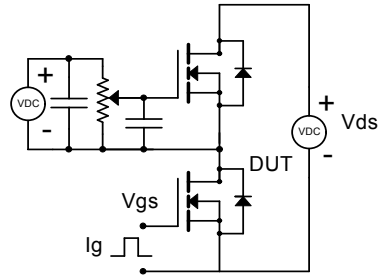
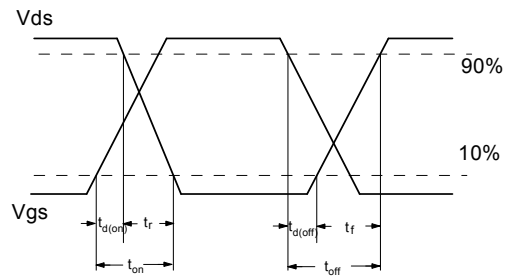
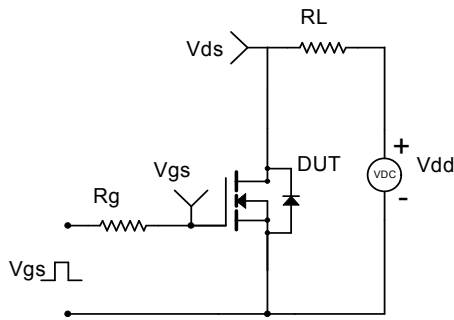

Figure 16: Normalized Maximum Transient Thermal Impedance for TO-220F Green (Note F)

Gate Charge Test Circuit & Waveform



Resistive Switching Test Circuit & Waveforms



Unclamped Inductive Switching (UIS) Test Circuit & Waveforms

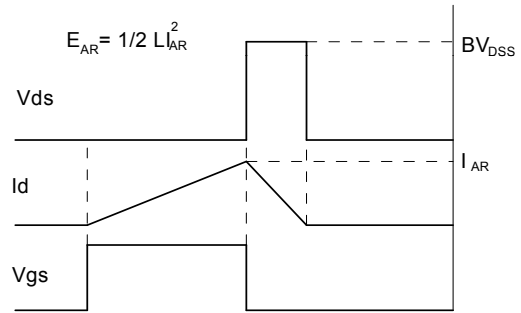
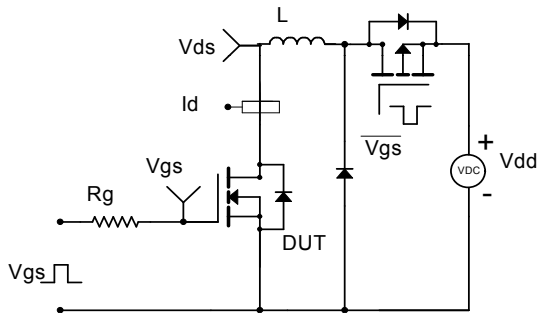

Diode Recovery Test Circuit & Waveforms

