

ADS42xx Dual-Channel, 14-/12-Bit, 160/125/65 MSPS Ultralow-Power ADC

1 Features

- Ultralow Power With Single 1.8-V Supply, CMOS Output:
 - 183 mW Total Power at 65 MSPS
 - 277 mW Total Power at 125 MSPS
 - 332 mW Total Power at 160 MSPS
- High Dynamic Performance:
 - 88-dBc SFDR at 170 MHz
 - 71.4-dBFS SNR at 170 MHz
- Crosstalk: > 90 dB at 185 MHz
- Programmable Gain up to 6 dB for SNR/SFDR Trade-off
- DC Offset Correction
- Output Interface Options:
 - 1.8-V parallel CMOS Interface
 - Double Data Rate (DDR) LVDS With Programmable swing:
 - Standard Swing: 350 mV
 - Low Swing: 200 mV
- Supports Low Input Clock Amplitude Down to 200 mV_{PP}
- Package: VQFN-64 (9.00 mm x 9.00 mm)

2 Applications

- Wireless Communications Infrastructure
- Software-Defined Radio
- Power Amplifier Linearization

3 Description

The ADS424x and ADS422x family of devices are low-speed variants of the ADS42xx ultralow-power family of dual-channel, 14-bit/12-bit analog-to-digital converters (ADCs). Innovative design techniques are used to achieve high-dynamic performance, while consuming extremely low power with 1.8-V supply. This topology makes the ADS424x/422x well-suited for multi-carrier, wide-bandwidth communications applications.

Device Information⁽¹⁾

PART NUMBER	PACKAGE	BODY SIZE (NOM)
ADS4222	VQFN (48)	9.00 mm x 9.00 mm
ADS4225		
ADS4226		
ADS4242		
ADS4245		
ADS4246		

(1) For all available packages, see the orderable addendum at the end of the data sheet.

ADS4222/25/26/42/45/46 Block Diagram

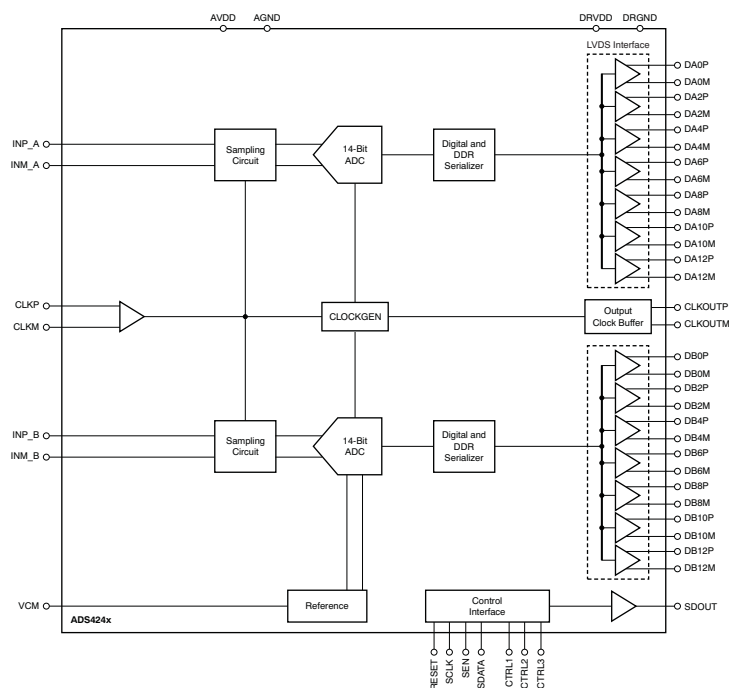

Table of Contents

1 Features	1	9.2 Functional Block Diagrams	49
2 Applications	1	9.3 Feature Description	51
3 Description	1	9.4 Device Functional Modes	57
4 Revision History	2	9.5 Programming	58
5 Description (continued)	3	9.6 Register Maps	67
6 ADS424x/422x Family Comparison	4	10 Application and Implementation	79
7 Pin Configuration and Functions	5	10.1 Application Information	79
8 Specifications	10	10.2 Typical Application	80
8.1 Absolute Maximum Ratings	10	11 Power Supply Recommendations	83
8.2 ESD Ratings	10	11.1 Sharing DRVDD and AVDD Supplies	83
8.3 Recommended Operating Conditions	11	11.2 Using DC/DC Power Supplies	83
8.4 Thermal Information	11	11.3 Power Supply Bypassing	83
8.5 Electrical Characteristics: ADS4246, ADS4245, ADS4242	12	12 Layout	83
8.6 Electrical Characteristics: ADS4226, ADS4225, ADS4222	15	12.1 Layout Guidelines	83
8.7 Electrical Characteristics: General	18	12.2 Layout Example	84
8.8 Digital Characteristics	19	13 Device and Documentation Support	85
8.9 Timing Requirements: LVDS and CMOS Modes	19	13.1 Device Support	85
8.10 Serial Interface Timing Characteristics	20	13.2 Documentation Support	86
8.11 Reset Timing (Only When Serial Interface Is Used)	20	13.3 Related Links	87
8.12 Typical Characteristics	25	13.4 Community Resources	87
9 Detailed Description	49	13.5 Trademarks	87
9.1 Overview	49	13.6 Electrostatic Discharge Caution	87
		13.7 Glossary	87
		14 Mechanical, Packaging, and Orderable Information	87

4 Revision History

NOTE: Page numbers for previous revisions may differ from page numbers in the current version.

Changes from Revision C (March 2011) to Revision D	Page
<ul style="list-style-type: none"> Added <i>ESD Ratings</i> table, <i>Feature Description</i> section, <i>Device Functional Modes</i>, <i>Application and Implementation</i> section, <i>Power Supply Recommendations</i> section, <i>Layout</i> section, <i>Device and Documentation Support</i> section, and <i>Mechanical, Packaging, and Orderable Information</i> section. 	1

Changes from Revision B (May 2011) to Revision C	Page
<ul style="list-style-type: none"> Changed device status from Mixed Status to Production Data Changed 125MSPS sub-bullet of first Features bullet Changed sub-bullets of second Features bullet Changed description of pin 64 in Pin Descriptions: LVDS Mode table Changed description of pin 64 in Pin Descriptions: CMOS Mode table Changed ADS4246 $f_{IN} = 170$ MHz <i>Worst spur</i> typical specification in the ADS4246/ADS4245/ADS4242 Electrical Characteristics table Added ADS4225/ADS4222 $f_{IN} = 70$ MHz <i>SNR</i>, <i>SINAD</i>, <i>SFDR</i>, <i>THD</i>, <i>HD2</i>, <i>HD3</i>, and <i>Worst spur</i> minimum and typical specifications in the ADS4226/ADS4225/ADS4222 Electrical Characteristics table Added ADS4225/ADS4222 <i>DNL</i> minimum and maximum specifications in the ADS4226/ADS4225/ADS4222 Electrical Characteristics table Added ADS4225/ADS4222 <i>INL</i> maximum specifications in the ADS4226/ADS4225/ADS4222 Electrical Characteristics table Changed ADS4242/ADS4222 Power Supply, <i>Digital power LVDS interface</i> typical specification in Electrical Characteristics: General table 	1 1 1 7 10 14 15 17 17 18

• Changed ADS4245/ADS4225 Power Supply, <i>Digital power CMOS interface</i> typical specification in Electrical Characteristics: General table	18
• Moved High-Performance Modes into separate table	21
• Changed description of READOUT disabled in <i>Serial Register Readout</i> section	60
• Updated Figure 152	61
• Changed READOUT description in <i>Register Address 00h</i> section	68
• Changed CLKOUT FALL POSN and CLKOUT RISE POSN description in <i>Register Address 42h</i> section	73

Changes from Revision A (May 2011) to Revision B
Page

• Changed sub-bullets of first Features bullet	1
• Updated description of NC pin in LVDS Pin Descriptions table	7
• Updated description of NC pin in CMOS Pin Descriptions table	10
• Changed <i>ENOB</i> , <i>DNL</i> , and <i>INL</i> test conditions in the Electrical Characteristics: ADS4246/ADS4245/ADS4242 table	14
• Deleted <i>INL</i> minimum specifications from Electrical Characteristics: ADS4246/ADS4245/ADS4242 table	14
• Changed <i>INL</i> maximum specifications in the Electrical Characteristics: ADS4246/ADS4245/ADS4242 table	14
• Changed <i>ENOB</i> , <i>DNL</i> , and <i>INL</i> test conditions in the Electrical Characteristics: ADS4226/ADS4225/ADS4222 table	17
• Changed ADS4226 <i>INL</i> maximum specification in the Electrical Characteristics: ADS4226/ADS4225/ADS4222 table	17
• Changed Power Supply, <i>IDRVDD</i> and <i>Digital power CMOS interface</i> rows in the Electrical Characteristics: General table	18
• Updated Figure 16	25
• Updated Figure 18	26
• Updated Figure 37 and Figure 38	29
• Updated Figure 39 and Figure 40	29
• Updated Figure 58 and Figure 59	33
• Updated Figure 60 and Figure 61	34
• Updated Figure 79 and Figure 80	37
• Updated Figure 81 and Figure 82	37
• Updated Figure 96	40
• Updated Figure 97 and SBAS533graph8650	40
• Updated Figure 115	43
• Updated Figure 127	46
• Changed title of Figure 128	46
• Updated ADS424x/422x Family <i>Pins</i> section in Table 4	51
• Changed <i>111110</i> and <i>001111</i> LVDS SWING description in Register Address 01h	68

5 Description (continued)

The ADS424x/422x have gain options that can be used to improve SFDR performance at lower full-scale input ranges. These devices include a dc offset correction loop that can be used to cancel the ADC offset. Both DDR (double data rate) LVDS and parallel CMOS digital output interfaces are available in a compact VQFN-64 package.

The devices include internal references while the traditional reference pins and associated decoupling capacitors have been eliminated. All devices are specified over the industrial temperature range (–40°C to 85°C).

6 ADS424x/422x Family Comparison

DEVICE FAMILY ⁽¹⁾	250 MSPS	160 MSPS	125 MSPS	65 MSPS
ADS424x 14-bit family	ADS4249	ADS4246	ADS4245	ADS4242
ADS422x 12-bit family	ADS4229	ADS4226	ADS4225	ADS4222

(1) See [Table 4](#) for details on migrating from the ADS62P49 family.

7 Pin Configuration and Functions

ADS4246, ADS4245, and ADS4242 RGC Package
64-Pin VQFN With Exposed Thermal Pad
LVDS Mode - Top View

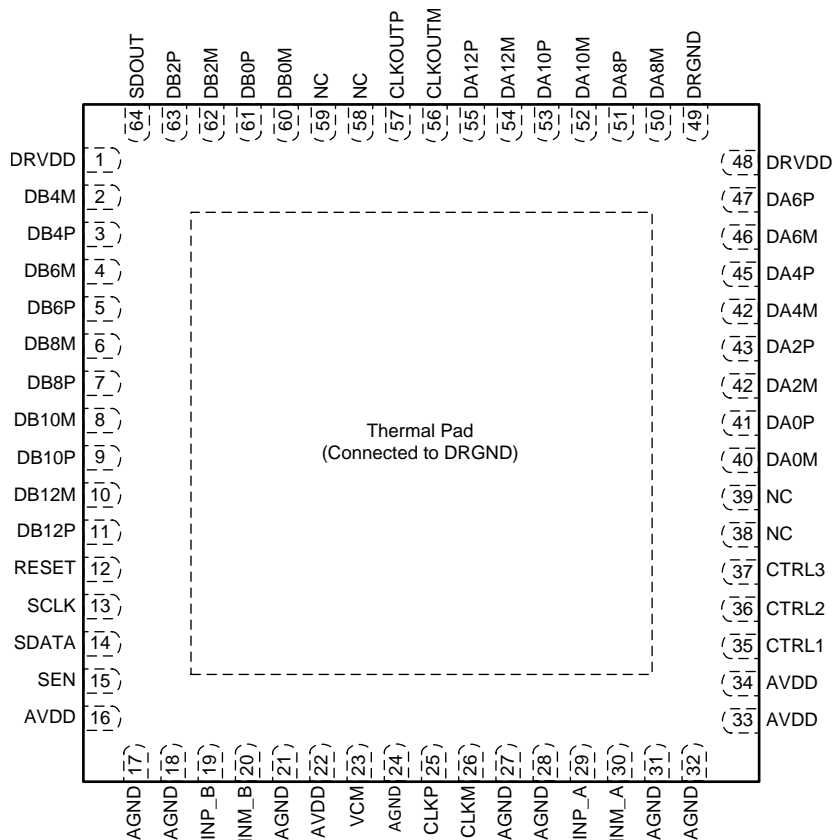

ADS4226, ADS4225, and ADS4222 RGC Package
64-Pin VQFN With Exposed Thermal Pad
LVDS Mode - Top View

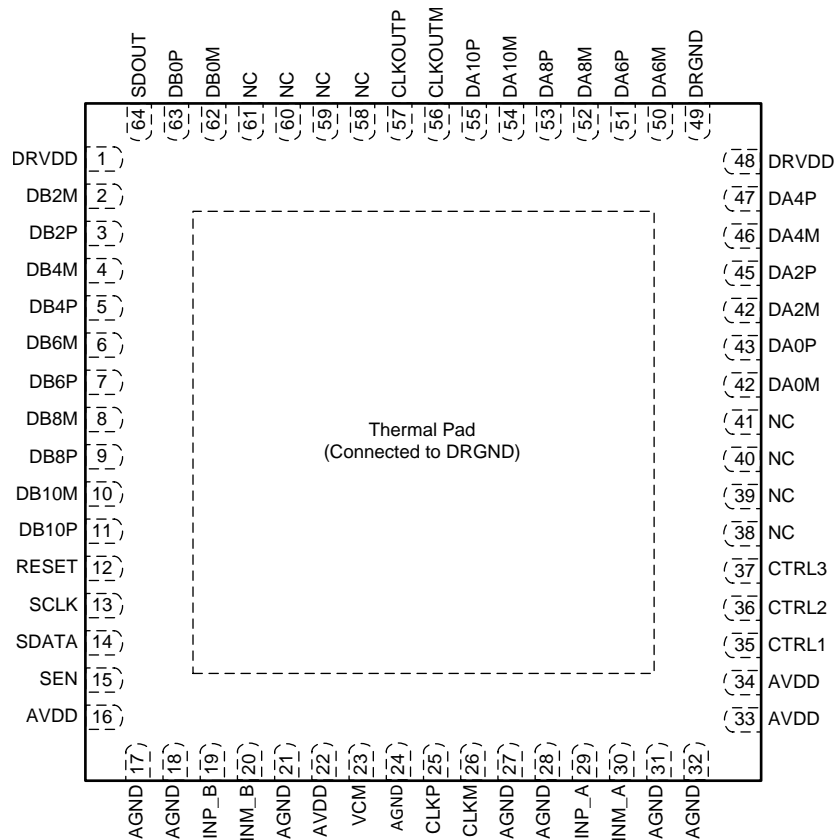

Pin Functions – LVDS Mode

PIN		I/O	DESCRIPTION
NAME	NO.		
AGND	17, 18, 21, 24, 27, 28, 31, 32	Input	Analog ground
AVDD	16, 22, 33, 34	Input	Analog power supply
CLKM	26	Input	Differential clock negative input
CLKOUTM	56	Output	Differential output clock, complement
CLKOUTP	57	Output	Differential output clock, true
CLKP	25	Input	Differential clock positive input
CTRL1	35	Input	Digital control input pins. Together, they control the various power-down modes.
CTRL2	36	Input	Digital control input pins. Together, they control the various power-down modes.
CTRL3	37	Input	Digital control input pins. Together, they control the various power-down modes.
DA0P, DA0M	Refer to pinout drawings	Output	Channel A differential output data pair, D0 and D1 multiplexed
DA2P, DA2M	Refer to pinout drawings	Output	Channel A differential output data D2 and D3 multiplexed
DA4P, DA4M	Refer to pinout drawings	Output	Channel A differential output data D4 and D5 multiplexed
DA6P, DA6M	Refer to pinout drawings	Output	Channel A differential output data D6 and D7 multiplexed
DA8P, DA8M	Refer to pinout drawings	Output	Channel A differential output data D8 and D9 multiplexed
DA10P, DA10M	Refer to pinout drawings	Output	Channel A differential output data D10 and D11 multiplexed

Pin Functions – LVDS Mode (continued)

PIN		I/O	DESCRIPTION
NAME	NO.		
DA12P, DA12M	Refer to pinout drawings	Output	Channel A differential output data D12 and D13 multiplexed (ADS424x only)
DB0P, DB0M	Refer to pinout drawings	Output	Channel B differential output data pair, D0 and D1 multiplexed
DB2P, DB2M	Refer to pinout drawings	Output	Channel B differential output data D2 and D3 multiplexed
DB4P, DB4M	Refer to pinout drawings	Output	Channel B differential output data D4 and D5 multiplexed
DB6P, DB6M	Refer to pinout drawings	Output	Channel B differential output data D6 and D7 multiplexed
DB8P, DB8M	Refer to pinout drawings	Output	Channel B differential output data D8 and D9 multiplexed
DB10P, DB10M	Refer to pinout drawings	Output	Channel B differential output data D10 and D11 multiplexed
DB12P, DB12M	Refer to pinout drawings	Output	Channel B differential output data D12 and D13 multiplexed (ADS424x only)
DRGND	49, PAD	Input	Output buffer ground
DRVDD	1, 48	Input	Output buffer supply
INM_A	30	Input	Differential analog negative input, channel A
INM_B	20	Input	Differential analog negative input, channel B
INP_A	29	Input	Differential analog positive input, channel A
INP_B	19	Input	Differential analog positive input, channel B
NC	Refer to Figure 28 , Figure 29 , and Figure 45	—	Do not connect, must be floated
RESET	12	Input	Serial interface RESET input. When using the serial interface mode, the internal registers must be initialized through a hardware RESET by applying a high pulse on this pin or by using the software reset option; refer to the Serial Interface Configuration section. In parallel interface mode, the RESET pin must be permanently tied high. SCLK and SEN are used as parallel control pins in this mode. This pin has an internal 150-kΩ pull-down resistor.
SCLK	13	Input	This pin functions as a serial interface clock input when RESET is low. It controls the low-speed mode selection when RESET is tied high; see Table 9 for detailed information. This pin has an internal 150-kΩ pull-down resistor.
SDATA	14	Input	Serial interface data input; this pin has an internal 150-kΩ pull-down resistor.
SDOUT	64	Output	This pin functions as a serial interface register readout when the READOUT bit is enabled. When READOUT = 0, this pin is in high-impedance state.
SEN	15	Input	This pin functions as a serial interface enable input when RESET is low. It controls the output interface and data format selection when RESET is tied high; see Table 10 for detailed information. This pin has an internal 150-kΩ pullup resistor to AVDD.
VCM	23	Output	This pin outputs the common-mode voltage (0.95 V) that can be used externally to bias the analog input pins

ADS4246, ADS4245, and ADS4242 RGC Package
 64-Pin VQFN With Exposed Thermal Pad
 CMOS Mode - Top View

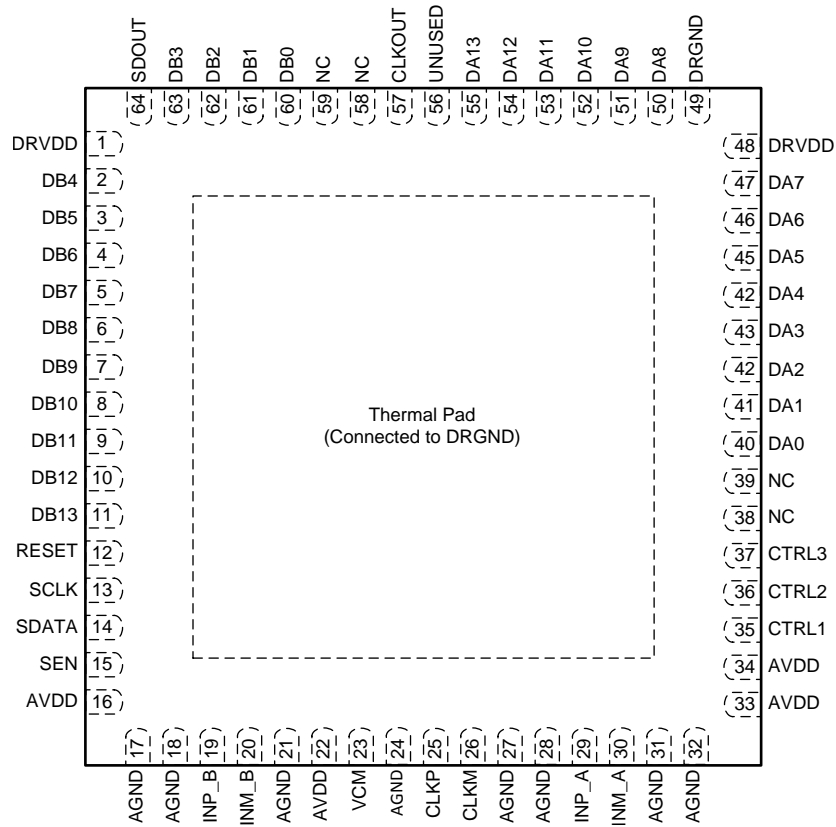

**ADS4226, ADS4225, and ADS4222 RGC Package
64-Pin VQFN With Exposed Thermal Pad
CMOS Mode - Top View**

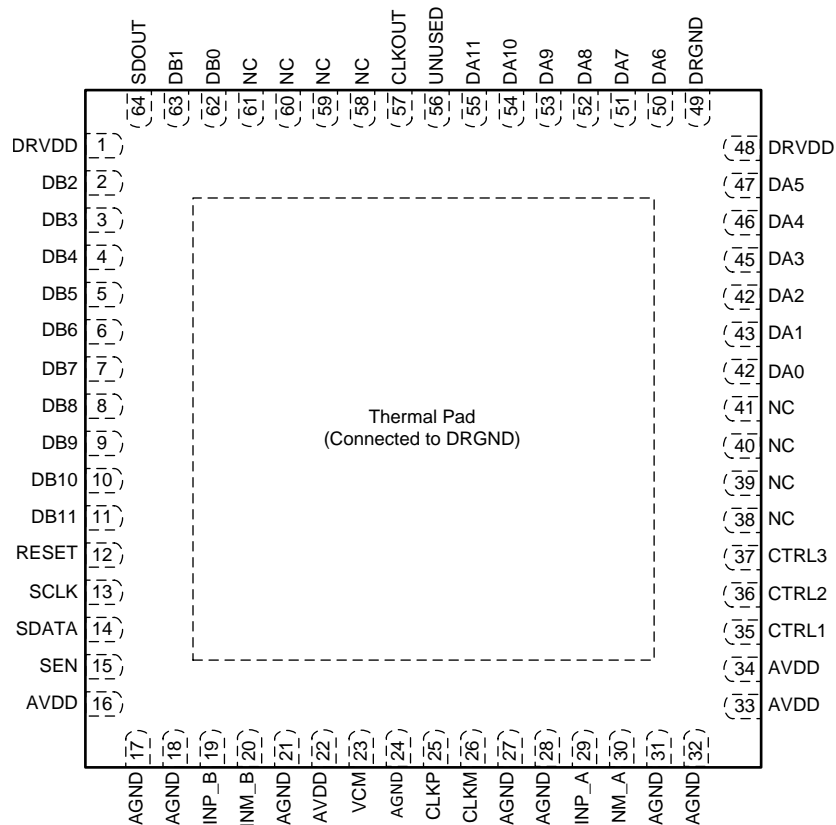

Pin Functions – CMOS Mode

PIN		I/O	DESCRIPTION
NAME	NO.		
AGND	17, 18, 21, 24, 27, 28, 31, 32	Input	Analog ground
AVDD	16, 22, 33, 34	Input	Analog power supply
CLKM	26	Input	Differential clock negative input
CLKOUT	57	Output	CMOS output clock
CLKP	25	Input	Differential clock positive input
CTRL1	35	Input	Digital control input pins. Together, they control various power-down modes.
CTRL2	36	Input	Digital control input pins. Together, they control various power-down modes.
CTRL3	37	Input	Digital control input pins. Together, they control various power-down modes.
DA0 to DA11	Refer to pinout drawings	Output	Channel A ADC output data bits, CMOS levels
DA12 to DA13	Refer to pinout drawings	Output	Channel A ADC output data bits, CMOS levels (ADS424x only)
DB0 to DB11	Refer to pinout drawings	Output	Channel B ADC output data bits, CMOS levels
DB12 to DB13	Refer to pinout drawings	Output	Channel B ADC output data bits, CMOS levels (ADS424x only)
DRGND	49, PAD	Input	Output buffer ground
DRVDD	1, 48	Input	Output buffer supply
INM_A	30	Input	Differential analog negative input, channel A
INM_B	20	Input	Differential analog negative input, channel B
INP_A	29	Input	Differential analog positive input, channel A

Pin Functions – CMOS Mode (continued)

PIN		I/O	DESCRIPTION
NAME	NO.		
INP_B	19	Input	Differential analog positive input, channel B
NC	—	—	Do not connect, must be floated
RESET	12	Input	Serial interface RESET input. When using the serial interface mode, the internal registers must be initialized through a hardware RESET by applying a high pulse on this pin or by using the software reset option; refer to the Serial Interface Configuration section. In parallel interface mode, the RESET pin must be permanently tied high. SDATA and SEN are used as parallel control pins in this mode. This pin has an internal 150-k Ω pulldown resistor.
SCLK	13	Input	This pin functions as a serial interface clock input when RESET is low. It controls the low-speed mode when RESET is tied high; see Table 9 for detailed information. This pin has an internal 150-k Ω pulldown resistor.
SDATA	14	Input	Serial interface data input; this pin has an internal 150-k Ω pulldown resistor.
SDOUT	64	Output	This pin functions as a serial interface register readout when the READOUT bit is enabled. When READOUT = 0, this pin is in high-impedance state.
SEN	15	Input	This pin functions as a serial interface enable input when RESET is low. It controls the output interface and data format selection when RESET is tied high; see Table 10 for detailed information. This pin has an internal 150-k Ω pullup resistor to AVDD.
UNUSED	56	—	This pin is not used in the CMOS interface
VCM	23	Output	This pin outputs the common-mode voltage (0.95 V) that can be used externally to bias the analog input pins

8 Specifications

8.1 Absolute Maximum Ratings

over operating free-air temperature range (unless otherwise noted)⁽¹⁾

	MIN	MAX	UNIT
Supply voltage range, AVDD	-0.3	2.1	V
Supply voltage range, DRVDD	-0.3	2.1	V
Voltage between AGND and DRGND	-0.3	0.3	V
Voltage between AVDD to DRVDD (when AVDD leads DRVDD)	-2.4	2.4	V
Voltage between DRVDD to AVDD (when DRVDD leads AVDD)	-2.4	2.4	V
Voltage applied to input pins	INP_A, INM_A, INP_B, INM_B	Minimum (1.9, AVDD + 0.3)	V
	CLKP, CLKM ⁽²⁾	AVDD + 0.3	V
	RESET, SCLK, SDATA, SEN, CTRL1, CTRL2, CTRL3	3.9	V
Operating free-air temperature range, T _A	-40	85	°C
Operating junction temperature range, T _J		125	°C
Storage temperature range, T _{stg}	-65	150	°C

- Stresses beyond those listed under *Absolute Maximum Ratings* may cause permanent damage to the device. These are stress ratings only, which do not imply functional operation of the device at these or any other conditions beyond those indicated under *Recommended Operating Conditions*. Exposure to absolute-maximum-rated conditions for extended periods may affect device reliability.
- When AVDD is turned off, it is recommended to switch off the input clock (or ensure the voltage on CLKP, CLKM is less than |0.3 V|). This configuration prevents the ESD protection diodes at the clock input pins from turning on.

8.2 ESD Ratings

	VALUE	UNIT
V _(ESD) Electrostatic discharge	Human-body model (HBM), per ANSI/ESDA/JEDEC JS-001 ⁽¹⁾	±2000
	Charged-device model (CDM), per JEDEC specification JESD22-C101 ⁽²⁾	±500

- JEDEC document JEP155 states that 500-V HBM allows safe manufacturing with a standard ESD control process.
- JEDEC document JEP157 states that 250-V CDM allows safe manufacturing with a standard ESD control process.

8.3 Recommended Operating Conditions

Over operating free-air temperature range, unless otherwise noted.

		MIN	NOM	MAX	UNIT	
SUPPLIES						
Analog supply voltage, AVDD		1.7	1.8	1.9	V	
Digital supply voltage, DRVDD		1.7	1.8	1.9	V	
ANALOG INPUTS						
Differential input voltage range		2			V _{PP}	
Input common-mode voltage		V _{CM} ± 0.05			V	
Maximum analog input frequency with 2 V _{PP} input amplitude ⁽¹⁾		400			MHz	
Maximum analog input frequency with 1 V _{PP} input amplitude ⁽¹⁾		600			MHz	
CLOCK INPUT						
Input clock sample rate (ADS4242/ADS4222)	Low-speed mode enabled (by default after reset)	1		65	MSPS	
Input clock sample rate (ADS4245/ADS4225)	Low-speed mode enabled ⁽²⁾	1		80	MSPS	
	Low-speed mode disabled ⁽²⁾ (by default after reset)	80		125		
Input clock sample rate (ADS4246/ADS4226)	Low-speed mode enabled ⁽²⁾	1		80	MSPS	
	Low-speed mode disabled ⁽²⁾ (by default after reset)	80		160	MSPS	
Input clock amplitude differential (V _{CLKP} – V _{CLKM})	Sine wave, ac-coupled	0.2	1.5		V _{PP}	
	LVPECL, ac-coupled		1.6		V _{PP}	
	LVDS, ac-coupled		0.7		V _{PP}	
	LVC MOS, single-ended, ac-coupled		1.5		V	
INPUT CLOCK DUTY CYCLE						
Low-speed mode disabled		35%	50%	65%		
Low-speed mode enabled		40%	50%	60%		
DIGITAL OUTPUTS						
Maximum external load capacitance from each output pin to DRGND, C _{LOAD}		5			pF	
Differential load resistance between the LVDS output pairs (LVDS mode), R _{LOAD}		100			Ω	
Operating free-air temperature, T _A		–40			85	°C

(1) See the [Application Information](#) section in the Application Information.

(2) See the [Serial Interface Configuration](#) section for details on programming the low-speed mode.

8.4 Thermal Information

THERMAL METRIC ⁽¹⁾		ADS42xx	UNIT
		RGC (VQFN)	
		64 PINS	
R _{θJA}	Junction-to-ambient thermal resistance	23.9	°C/W
R _{θJC(top)}	Junction-to-case (top) thermal resistance	10.9	°C/W
R _{θJB}	Junction-to-board thermal resistance	4.3	°C/W
Ψ _{JT}	Junction-to-top characterization parameter	0.1	°C/W
Ψ _{JB}	Junction-to-board characterization parameter	4.4	°C/W
R _{θJC(bot)}	Junction-to-case (bottom) thermal resistance	0.6	°C/W

(1) For more information about traditional and new thermal metrics, see the *Semiconductor and IC Package Thermal Metrics* application report (SPRA953).

8.5 Electrical Characteristics: ADS4246, ADS4245, ADS4242

Typical values are at 25°C, AVDD = 1.8 V, DRVDD = 1.8 V, 50% clock duty cycle, –1 dBFS differential analog input, LVDS interface, and 0-dB gain, unless otherwise noted. Minimum and maximum values are across the full temperature range: T_{MIN} = –40°C to T_{MAX} = 85°C, AVDD = 1.8 V, and DRVDD = 1.8 V.

PARAMETER		TEST CONDITIONS		MIN	TYP	MAX	UNIT
Resolution						14	Bits
Signal-to-noise ratio	SNR	f _{IN} = 20 MHz	ADS4246 (160 MSPS)		72.8		dBFS
			ADS4245 (125 MSPS)		73.4		
			ADS4242 (65 MSPS)		73.6		
		f _{IN} = 70 MHz	ADS4246 (160 MSPS)		72.5		dBFS
			ADS4245 (125 MSPS)	70	72.9		
			ADS4242 (65 MSPS)	69.5	72.5		
		f _{IN} = 100 MHz	ADS4246 (160 MSPS)		72.2		dBFS
			ADS4245 (125 MSPS)		72.6		
			ADS4242 (65 MSPS)		72.3		
		f _{IN} = 170 MHz	ADS4246 (160 MSPS)	69	71.2		dBFS
			ADS4245 (125 MSPS)		71.4		
			ADS4242 (65 MSPS)		70.4		
		f _{IN} = 300 MHz	ADS4246 (160 MSPS)		69.4		dBFS
			ADS4245 (125 MSPS)		69.3		
			ADS4242 (65 MSPS)		69.4		
Signal-to-noise and distortion ratio	SINAD	f _{IN} = 20 MHz	ADS4246 (160 MSPS)		72.6		dBFS
			ADS4245 (125 MSPS)		73.2		
			ADS4242 (65 MSPS)		73.5		
		f _{IN} = 70 MHz	ADS4246 (160 MSPS)		72.1		dBFS
			ADS4245 (125 MSPS)	69	72.6		
			ADS4242 (65 MSPS)	68.5	72.3		
		f _{IN} = 100 MHz	ADS4246 (160 MSPS)		71.7		dBFS
			ADS4245 (125 MSPS)		72.3		
			ADS4242 (65 MSPS)		72.1		
		f _{IN} = 170 MHz	ADS4246 (160 MSPS)	67.5	70.8		dBFS
			ADS4245 (125 MSPS)		71.2		
			ADS4242 (65 MSPS)		70.2		
		f _{IN} = 300 MHz	ADS4246 (160 MSPS)		68		dBFS
			ADS4245 (125 MSPS)		68.5		
			ADS4242 (65 MSPS)		68.2		
Spurious-free dynamic range	SFDR	f _{IN} = 20 MHz	ADS4246 (160 MSPS)		86		dBc
			ADS4245 (125 MSPS)		88		
			ADS4242 (65 MSPS)		91		
		f _{IN} = 70 MHz	ADS4246 (160 MSPS)		84		dBc
			ADS4245 (125 MSPS)	73.5	86		
			ADS4242 (65 MSPS)	73.5	88		
		f _{IN} = 100 MHz	ADS4246 (160 MSPS)		82		dBc
			ADS4245 (125 MSPS)		85		
			ADS4242 (65 MSPS)		87		
		f _{IN} = 170 MHz	ADS4246 (160 MSPS)	72	82		dBc
			ADS4245 (125 MSPS)		88		
			ADS4242 (65 MSPS)		85		
		f _{IN} = 300 MHz	ADS4246 (160 MSPS)		78		dBc
			ADS4245 (125 MSPS)		78		
			ADS4242 (65 MSPS)		74		

Electrical Characteristics: ADS4246, ADS4245, ADS4242 (continued)

Typical values are at 25°C, AVDD = 1.8 V, DRVDD = 1.8 V, 50% clock duty cycle, –1 dBFS differential analog input, LVDS interface, and 0-dB gain, unless otherwise noted. Minimum and maximum values are across the full temperature range: T_{MIN} = –40°C to T_{MAX} = 85°C, AVDD = 1.8 V, and DRVDD = 1.8 V.

PARAMETER		TEST CONDITIONS		MIN	TYP	MAX	UNIT	
Total harmonic distortion	f _{IN} = 20 MHz	ADS4246 (160 MSPS)			84		dBc	
		ADS4245 (125 MSPS)			86			
		ADS4242 (65 MSPS)			88			
	f _{IN} = 70 MHz	ADS4246 (160 MSPS)				81		dBc
		ADS4245 (125 MSPS)		72		84		
		ADS4242 (65 MSPS)		72		85		
	f _{IN} = 100 MHz	ADS4246 (160 MSPS)				81		dBc
		ADS4245 (125 MSPS)				83		
		ADS4242 (65 MSPS)				85		
	f _{IN} = 170 MHz	ADS4246 (160 MSPS)		70		80		dBc
		ADS4245 (125 MSPS)				84		
		ADS4242 (65 MSPS)				82		
	f _{IN} = 300 MHz	ADS4246 (160 MSPS)				76		dBc
		ADS4245 (125 MSPS)				75		
		ADS4242 (65 MSPS)				73		
Second-harmonic distortion	f _{IN} = 20 MHz	ADS4246 (160 MSPS)			86		dBc	
		ADS4245 (125 MSPS)			88			
		ADS4242 (65 MSPS)			91			
	f _{IN} = 70 MHz	ADS4246 (160 MSPS)				84		dBc
		ADS4245 (125 MSPS)		73.5		86		
		ADS4242 (65 MSPS)		73.5		88		
	f _{IN} = 100 MHz	ADS4246 (160 MSPS)				82		dBc
		ADS4245 (125 MSPS)				85		
		ADS4242 (65 MSPS)				87		
	f _{IN} = 170 MHz	ADS4246 (160 MSPS)		72		82		dBc
		ADS4245 (125 MSPS)				88		
		ADS4242 (65 MSPS)				85		
	f _{IN} = 300 MHz	ADS4246 (160 MSPS)				78		dBc
		ADS4245 (125 MSPS)				78		
		ADS4242 (65 MSPS)				74		
Third-harmonic distortion	f _{IN} = 20 MHz	ADS4246 (160 MSPS)			92		dBc	
		ADS4245 (125 MSPS)			93			
		ADS4242 (65 MSPS)			95			
	f _{IN} = 70 MHz	ADS4246 (160 MSPS)				86		dBc
		ADS4245 (125 MSPS)		73.5		89		
		ADS4242 (65 MSPS)		73.5		90		
	f _{IN} = 100 MHz	ADS4246 (160 MSPS)				93		dBc
		ADS4245 (125 MSPS)				89		
		ADS4242 (65 MSPS)				96		
	f _{IN} = 170 MHz	ADS4246 (160 MSPS)		72		94		dBc
		ADS4245 (125 MSPS)				90		
		ADS4242 (65 MSPS)				87		
	f _{IN} = 300 MHz	ADS4246 (160 MSPS)				80		dBc
		ADS4245 (125 MSPS)				81		
		ADS4242 (65 MSPS)				81		

Electrical Characteristics: ADS4246, ADS4245, ADS4242 (continued)

Typical values are at 25°C, AVDD = 1.8 V, DRVDD = 1.8 V, 50% clock duty cycle, –1 dBFS differential analog input, LVDS interface, and 0-dB gain, unless otherwise noted. Minimum and maximum values are across the full temperature range: T_{MIN} = –40°C to T_{MAX} = 85°C, AVDD = 1.8 V, and DRVDD = 1.8 V.

PARAMETER		TEST CONDITIONS		MIN	TYP	MAX	UNIT	
Worst spur (other than second and third harmonics)	f _{IN} = 20 MHz	ADS4246 (160 MSPS)			90		dBc	
		ADS4245 (125 MSPS)			95			
		ADS4242 (65 MSPS)			98			
	f _{IN} = 70 MHz	ADS4246 (160 MSPS)				92		dBc
		ADS4245 (125 MSPS)		78		94		
		ADS4242 (65 MSPS)		79		97		
	f _{IN} = 100 MHz	ADS4246 (160 MSPS)				89		dBc
		ADS4245 (125 MSPS)				93		
		ADS4242 (65 MSPS)				95		
	f _{IN} = 170 MHz	ADS4246 (160 MSPS)		77		89		dBc
		ADS4245 (125 MSPS)				91		
		ADS4242 (65 MSPS)				93		
	f _{IN} = 300 MHz	ADS4246 (160 MSPS)				91		dBc
		ADS4245 (125 MSPS)				89		
		ADS4242 (65 MSPS)				92		
Two-tone intermodulation distortion	IMD	f ₁ = 46 MHz, f ₂ = 50 MHz, each tone at –7 dBFS	ADS4246 (160 MSPS)			96	dBFS	
			ADS4245 (125 MSPS)			96		
			ADS4242 (65 MSPS)			98		
		f ₁ = 185 MHz, f ₂ = 190 MHz, each tone at –7 dBFS	ADS4246 (160 MSPS)			83	dBFS	
			ADS4245 (125 MSPS)			92		
			ADS4242 (65 MSPS)			92		
Crosstalk		20-MHz full-scale signal on channel under observation; 170-MHz full-scale signal on other channel			95		dB	
Input overload recovery		Recovery to within 1% (of full-scale) for 6-dB overload with sine-wave input			1		Clock cycle	
AC power-supply rejection ratio	PSRR	For 100-mV _{PP} signal on AVDD supply, up to 10 MHz			> 30		dB	
Effective number of bits	ENOB	f _{IN} = 70 MHz (ADS4245, ADS4242) f _{IN} = 170 MHz (ADS4246)			11.5		LSBs	
Differential nonlinearity	DNL	f _{IN} = 70 MHz (ADS4245, ADS4242) f _{IN} = 170 MHz (ADS4246)		–0.97	±0.5	+1.7	LSBs	
Integrated nonlinearity	INL	f _{IN} = 70 MHz (ADS4245, ADS4242) f _{IN} = 170 MHz (ADS4246)			±2	±5	LSBs	

8.6 Electrical Characteristics: ADS4226, ADS4225, ADS4222

Typical values are at 25°C, AVDD = 1.8 V, DRVDD = 1.8 V, 50% clock duty cycle, –1 dBFS differential analog input, LVDS interface, and 0-dB gain, unless otherwise noted. Minimum and maximum values are across the full temperature range:

T_{MIN} = –40°C to T_{MAX} = 85°C, AVDD = 1.8 V, and DRVDD = 1.8 V.

PARAMETER		TEST CONDITIONS		MIN	TYP	MAX	UNIT	
Resolution				12			Bits	
Signal-to-noise ratio	SNR	f _{IN} = 20 MHz	ADS4226 (160 MSPS)	70.5			dBFS	
			ADS4225 (125 MSPS)	70.8				
			ADS4222 (65 MSPS)	70.9				
		f _{IN} = 70 MHz	ADS4226 (160 MSPS)	70.3		68	70.5	dBFS
			ADS4225 (125 MSPS)	68				
			ADS4222 (65 MSPS)	68				
		f _{IN} = 100 MHz	ADS4226 (160 MSPS)	70.1			70.3	dBFS
			ADS4225 (125 MSPS)	70.3				
			ADS4222 (65 MSPS)	70.2				
		f _{IN} = 170 MHz	ADS4226 (160 MSPS)	67.5		69.5	69.9	dBFS
			ADS4225 (125 MSPS)	69.9				
			ADS4222 (65 MSPS)	69.9				
		f _{IN} = 300 MHz	ADS4226 (160 MSPS)	68.2		68.1	68.2	dBFS
			ADS4225 (125 MSPS)	68.1				
			ADS4222 (65 MSPS)	68.2				
Signal-to-noise and distortion ratio	SINAD	f _{IN} = 20 MHz	ADS4226 (160 MSPS)	70.4			dBFS	
			ADS4225 (125 MSPS)	70.7				
			ADS4222 (65 MSPS)	70.8				
		f _{IN} = 70 MHz	ADS4226 (160 MSPS)	70.1		67	70.3	dBFS
			ADS4225 (125 MSPS)	67				
			ADS4222 (65 MSPS)	67				
		f _{IN} = 100 MHz	ADS4226 (160 MSPS)	69.8			70.1	dBFS
			ADS4225 (125 MSPS)	70.1				
			ADS4222 (65 MSPS)	70.1				
		f _{IN} = 170 MHz	ADS4226 (160 MSPS)	66.5		69.3	69.5	dBFS
			ADS4225 (125 MSPS)	69.5				
			ADS4222 (65 MSPS)	68.7				
		f _{IN} = 300 MHz	ADS4226 (160 MSPS)	67.6		67.5	67.2	dBFS
			ADS4225 (125 MSPS)	67.5				
			ADS4222 (65 MSPS)	67.2				
Spurious-free dynamic range	SFDR	f _{IN} = 20 MHz	ADS4226 (160 MSPS)	86			dBc	
			ADS4225 (125 MSPS)	88				
			ADS4222 (65 MSPS)	91				
		f _{IN} = 70 MHz	ADS4226 (160 MSPS)	84		72.5	86	dBc
			ADS4225 (125 MSPS)	72.5				
			ADS4222 (65 MSPS)	72.5				
		f _{IN} = 100 MHz	ADS4226 (160 MSPS)	82			85	dBc
			ADS4225 (125 MSPS)	85				
			ADS4222 (65 MSPS)	87				
		f _{IN} = 170 MHz	ADS4226 (160 MSPS)	70		82	88	dBc
			ADS4225 (125 MSPS)	88				
			ADS4222 (65 MSPS)	85				
		f _{IN} = 300 MHz	ADS4226 (160 MSPS)	78		78	74	dBc
			ADS4225 (125 MSPS)	78				
			ADS4222 (65 MSPS)	74				

Electrical Characteristics: ADS4226, ADS4225, ADS4222 (continued)

Typical values are at 25°C, AVDD = 1.8 V, DRVDD = 1.8 V, 50% clock duty cycle, –1 dBFS differential analog input, LVDS interface, and 0-dB gain, unless otherwise noted. Minimum and maximum values are across the full temperature range:

T_{MIN} = –40°C to T_{MAX} = 85°C, AVDD = 1.8 V, and DRVDD = 1.8 V.

PARAMETER		TEST CONDITIONS		MIN	TYP	MAX	UNIT
Total harmonic distortion	THD	f _{IN} = 20 MHz	ADS4226 (160 MSPS)		84		dBc
			ADS4225 (125 MSPS)		86		
			ADS4222 (65 MSPS)		88		
		f _{IN} = 70 MHz	ADS4226 (160 MSPS)		81		dBc
			ADS4225 (125 MSPS)	70	84		
			ADS4222 (65 MSPS)	71	85		
		f _{IN} = 100 MHz	ADS4226 (160 MSPS)		81		dBc
			ADS4225 (125 MSPS)		83		
			ADS4222 (65 MSPS)		85		
	f _{IN} = 170 MHz	ADS4226 (160 MSPS)	68	80		dBc	
		ADS4225 (125 MSPS)		84			
		ADS4222 (65 MSPS)		82			
	f _{IN} = 300 MHz	ADS4226 (160 MSPS)		76		dBc	
		ADS4225 (125 MSPS)		75			
		ADS4222 (65 MSPS)		73			
Second-harmonic distortion	HD2	f _{IN} = 20 MHz	ADS4226 (160 MSPS)		86		dBc
			ADS4225 (125 MSPS)		88		
			ADS4222 (65 MSPS)		91		
		f _{IN} = 70 MHz	ADS4226 (160 MSPS)		84		dBc
			ADS4225 (125 MSPS)	72.5	86		
			ADS4222 (65 MSPS)	72.5	88		
		f _{IN} = 100 MHz	ADS4226 (160 MSPS)		82		dBc
			ADS4225 (125 MSPS)		85		
			ADS4222 (65 MSPS)		87		
	f _{IN} = 170 MHz	ADS4226 (160 MSPS)	70	82		dBc	
		ADS4225 (125 MSPS)		88			
		ADS4222 (65 MSPS)		85			
	f _{IN} = 300 MHz	ADS4226 (160 MSPS)		78		dBc	
		ADS4225 (125 MSPS)		78			
		ADS4222 (65 MSPS)		74			
Third-harmonic distortion	HD3	f _{IN} = 20 MHz	ADS4226 (160 MSPS)		92		dBc
			ADS4225 (125 MSPS)		93		
			ADS4222 (65 MSPS)		95		
		f _{IN} = 70 MHz	ADS4226 (160 MSPS)		86		dBc
			ADS4225 (125 MSPS)	72.5	89		
			ADS4222 (65 MSPS)	72.5	90		
		f _{IN} = 100 MHz	ADS4226 (160 MSPS)		93		dBc
			ADS4225 (125 MSPS)		89		
			ADS4222 (65 MSPS)		96		
	f _{IN} = 170 MHz	ADS4226 (160 MSPS)	70	94		dBc	
		ADS4225 (125 MSPS)		90			
		ADS4222 (65 MSPS)		87			
	f _{IN} = 300 MHz	ADS4226 (160 MSPS)		80		dBc	
		ADS4225 (125 MSPS)		81			
		ADS4222 (65 MSPS)		81			

Electrical Characteristics: ADS4226, ADS4225, ADS4222 (continued)

Typical values are at 25°C, AVDD = 1.8 V, DRVDD = 1.8 V, 50% clock duty cycle, –1 dBFS differential analog input, LVDS interface, and 0-dB gain, unless otherwise noted. Minimum and maximum values are across the full temperature range:

T_{MIN} = –40°C to T_{MAX} = 85°C, AVDD = 1.8 V, and DRVDD = 1.8 V.

PARAMETER		TEST CONDITIONS		MIN	TYP	MAX	UNIT	
Worst spur (other than second and third harmonics)	f _{IN} = 20 MHz	ADS4226 (160 MSPS)			90		dBc	
		ADS4225 (125 MSPS)			95			
		ADS4222 (65 MSPS)			98			
	f _{IN} = 70 MHz	ADS4226 (160 MSPS)			92		dBc	
		ADS4225 (125 MSPS)		76	94			
		ADS4222 (65 MSPS)		77	97			
	f _{IN} = 100 MHz	ADS4226 (160 MSPS)			89		dBc	
		ADS4225 (125 MSPS)			93			
		ADS4222 (65 MSPS)			95			
	f _{IN} = 170 MHz	ADS4226 (160 MSPS)		75	89		dBc	
		ADS4225 (125 MSPS)			91			
		ADS4222 (65 MSPS)			93			
	f _{IN} = 300 MHz	ADS4226 (160 MSPS)			91		dBc	
		ADS4225 (125 MSPS)			89			
		ADS4222 (65 MSPS)			92			
Two-tone intermodulation distortion	IMD	f ₁ = 46 MHz, f ₂ = 50 MHz, each tone at –7 dBFS		ADS4226 (160 MSPS)		96	dBFS	
				ADS4225 (125 MSPS)		96		
				ADS4222 (65 MSPS)		98		
		f ₁ = 185 MHz, f ₂ = 190 MHz, each tone at –7 dBFS		ADS4226 (160 MSPS)		83	dBFS	
				ADS4225 (125 MSPS)		92		
				ADS4222 (65 MSPS)		92		
Crosstalk		20-MHz full-scale signal on channel under observation; 170-MHz full-scale signal on other channel			95		dB	
Input overload recovery		Recovery to within 1% (of full-scale) for 6-dB overload with sine-wave input			1		Clock cycle	
AC power-supply rejection ratio	PSRR	For 100-mV _{pp} signal on AVDD supply, up to 10 MHz			30		dB	
Effective number of bits	ENOB	f _{IN} = 70 MHz (ADS4225, ADS4222) f _{IN} = 170 MHz (ADS4226)	ADS4226 (160 MSPS)		11.2		LSBs	
			ADS4225 (125 MSPS)		11.3			
			ADS4222 (65 MSPS)		11.1			
Differential nonlinearity	DNL	f _{IN} = 70 MHz (ADS4225, ADS4222) f _{IN} = 170 MHz (ADS4226)	ADS4226 (160 MSPS)		–0.8	±0.13	+1.5	LSBs
			ADS4225 (125 MSPS)		–0.8	±0.13	+1.5	
			ADS4222 (65 MSPS)		–0.8	±0.13	+1.2	
Integrated nonlinearity	INL	f _{IN} = 70 MHz (ADS4225, ADS4222) f _{IN} = 170 MHz (ADS4226)	ADS4226 (160 MSPS)		±0.5	±3.5	LSBs	
			ADS4225 (125 MSPS)		±0.5	±3.5		
			ADS4222 (65 MSPS)		±0.5	±2.5		

8.7 Electrical Characteristics: General

Typical values are at 25°C, AVDD = 1.8 V, DRVDD = 1.8 V, 50% clock duty cycle, and –1 dBFS differential analog input, unless otherwise noted. Minimum and maximum values are across the full temperature range: T_{MIN} = –40°C to T_{MAX} = 85°C, AVDD = 1.8 V, and DRVDD = 1.8 V.

PARAMETER		TEST CONDITIONS	MIN	TYP	MAX	UNIT		
ANALOG INPUTS								
Differential input voltage range		0 dB gain		2		V _{PP}		
Differential input resistance		At 200 MHz		0.75		kΩ		
Differential input capacitance		At 200 MHz		3.7		pF		
Analog input bandwidth		With 50-Ω source impedance, and 50-Ω termination		550		MHz		
Analog input common-mode current		Per input pin of each channel		1.5		μA/MSPS		
Common-mode output voltage		VCM		0.95		V		
VCM output current capability				4		mA		
DC ACCURACY								
Offset error			–15	2.5	15	mV		
Temperature coefficient of offset error				0.003		mV/°C		
Gain error as a result of internal reference inaccuracy alone		E _{GREF}	–2		2	%FS		
Gain error of channel alone		E _{GCHAN}	ADS4246/ADS4226 (160 MSPS)		±0.1	–1	%FS	
			ADS4245/ADS4225 (125 MSPS)		±0.1			
			ADS4242/ADS4222 (65 MSPS)		±0.1	–1		
Temperature coefficient of E _{GCHAN}				0.002		Δ%/°C		
POWER SUPPLY								
IAVDD Analog supply current		ADS4246/ADS4226 (160 MSPS)		123	150	mA		
		ADS4245/ADS4225 (125 MSPS)		105	130			
		ADS4242/ADS4222 (65 MSPS)		73	85			
IDRVDD Output buffer supply current		LVDS interface, 350-mV swing with 100-Ω external termination, f _{IN} = 2.5 MHz		ADS4246/ADS4226 (160 MSPS)		mA		
				ADS4245/ADS4225 (125 MSPS)			111	135
				ADS4242/ADS4222 (65 MSPS)			99	120
IDRVDD Output buffer supply current		CMOS interface, no load capacitance ⁽¹⁾ f _{IN} = 2.5 MHz		ADS4246/ADS4226 (160 MSPS)		mA		
				ADS4245/ADS4225 (125 MSPS)			78	95
				ADS4242/ADS4222 (65 MSPS)			61	
Analog power		ADS4246/ADS4226 (160 MSPS)		222		mW		
		ADS4245/ADS4225 (125 MSPS)		189				
		ADS4242/ADS4222 (65 MSPS)		133				
Digital power		LVDS interface, 350-mV swing with 100-Ω external termination, f _{IN} = 2.5 MHz		ADS4246/ADS4226 (160 MSPS)		mW		
				ADS4245/ADS4225 (125 MSPS)			199	
				ADS4242/ADS4222 (65 MSPS)			179	
Digital power		CMOS interface, no load capacitance ⁽¹⁾ f _{IN} = 2.5 MHz		ADS4246/ADS4226 (160 MSPS)		mW		
				ADS4245/ADS4225 (125 MSPS)			109	
				ADS4242/ADS4222 (65 MSPS)			88	
Global power-down					25	mW		

- (1) In CMOS mode, the DRVDD current scales with the sampling frequency, the load capacitance on output pins, input frequency, and the supply voltage (see the [CMOS Interface Power Dissipation](#) section in the [Application Information](#)).

8.8 Digital Characteristics

At AVDD = 1.8 V and DRVDD = 1.8 V, unless otherwise noted. DC specifications refer to the condition where the digital outputs do not switch, but are permanently at a valid logic level 0 or 1.

PARAMETER		TEST CONDITIONS	MIN	TYP	MAX	UNIT
DIGITAL INPUTS (RESET, SCLK, SDATA, SEN, CTRL1, CTRL2, CTRL3)⁽¹⁾						
High-level input voltage		All digital inputs support 1.8-V and 3.3-V CMOS logic levels	1.3			V
Low-level input voltage		All digital inputs support 1.8-V and 3.3-V CMOS logic levels			0.4	V
High-level input current	SDATA, SCLK ⁽²⁾	V _{HIGH} = 1.8 V		10		μA
	SEN ⁽³⁾	V _{HIGH} = 1.8 V		0		μA
Low-level input current	SDATA, SCLK	V _{LOW} = 0 V		0		μA
	SEN	V _{LOW} = 0 V		10		μA
DIGITAL OUTPUTS, CMOS INTERFACE (DA[13:0], DB[13:0], CLKOUT, SDOUT)						
High-level output voltage			DRVDD – 0.1	DRVDD		V
Low-level output voltage				0	0.1	V
Output capacitance (internal to device)						pF
DIGITAL OUTPUTS, LVDS INTERFACE						
High-level output differential voltage	V _{ODH}	With an external 100-Ω termination	270	350	430	mV
Low-level output differential voltage	V _{ODL}	With an external 100-Ω termination	–430	–350	–270	mV
Output common-mode voltage	V _{OCM}		0.9	1.05	1.25	V

- (1) SCLK, SDATA, and SEN function as digital input pins in serial configuration mode.
- (2) SDATA, SCLK have internal 150-kΩ pull-down resistor.
- (3) SEN has an internal 150-kΩ pull-up resistor to AVDD. Because the pull-up is weak, SEN can also be driven by 1.8-V or 3.3-V CMOS buffers.

8.9 Timing Requirements: LVDS and CMOS Modes⁽¹⁾

Typical values are at 25°C, AVDD = 1.8 V, DRVDD = 1.8 V, sampling frequency = 160MSPS, sine wave input clock, 1.5 V_{PP} clock amplitude, C_{LOAD} = 5 pF⁽²⁾, and R_{LOAD} = 100 Ω⁽³⁾, unless otherwise noted. Minimum and maximum values are across the full temperature range: T_{MIN} = –40°C to T_{MAX} = 85°C, AVDD = 1.8 V, and DRVDD = 1.7 V to 1.9 V.

			MIN	NOM	MAX	UNIT
t _A	Aperture delay		0.5	0.8	1.1	ns
	Aperture delay matching	Between the two channels of the same device		±70		ps
	Variation of aperture delay	Between two devices at the same temperature and DRVDD supply		±150		ps
t _J	Aperture jitter			140		f _S rms
	Wakeup time	Time to valid data after coming out of STANDBY mode		50	100	μs
		Time to valid data after coming out of GLOBAL power-down mode		100	500	μs
	ADC latency ⁽⁴⁾	Default latency after reset		16		Clock cycles
		Digital functions enabled (EN DIGITAL = 1)		24		Clock cycles
DDR LVDS MODE⁽⁵⁾						
t _{SU}	Data setup time	Data valid ⁽⁶⁾ to zero-crossing of CLKOUTP	1.5	2		ns
t _H	Data hold time	Zero-crossing of CLKOUTP to data becoming invalid ⁽⁶⁾	0.35	0.6		ns

- (1) Timing parameters are ensured by design and characterization and not tested in production.
- (2) C_{LOAD} is the effective external single-ended load capacitance between each output pin and ground
- (3) R_{LOAD} is the differential load resistance between the LVDS output pair.
- (4) At higher frequencies, t_{PDJ} is greater than one clock period and overall latency = ADC latency + 1.
- (5) Measurements are done with a transmission line of 100Ω characteristic impedance between the device and the load. Setup and hold time specifications take into account the effect of jitter on the output data and clock.
- (6) Data valid refers to a logic high of +100 mV and a logic low of –100 mV.

Timing Requirements: LVDS and CMOS Modes⁽¹⁾ (continued)

Typical values are at 25°C, AVDD = 1.8 V, DRVDD = 1.8 V, sampling frequency = 160MSPS, sine wave input clock, 1.5 V_{PP} clock amplitude, C_{LOAD} = 5 pF⁽²⁾, and R_{LOAD} = 100 Ω⁽³⁾, unless otherwise noted. Minimum and maximum values are across the full temperature range: T_{MIN} = –40°C to T_{MAX} = 85°C, AVDD = 1.8 V, and DRVDD = 1.7 V to 1.9 V.

			MIN	NOM	MAX	UNIT
t _{PDI}	Clock propagation delay	Input clock rising edge cross-over to output clock rising edge cross-over	5	6.1	7.5	ns
	LVDS bit clock duty cycle	Duty cycle of differential clock, (CLKOUTP-CLKOUTM)		49%		
t _{RISE} , t _{FALL}	Data rise time, Data fall time	Rise time measured from –100 mV to +100 mV Fall time measured from +100 mV to –100 mV 1MSPS ≤ Sampling frequency ≤ 160MSPS		0.13		ns
t _{CLKRISE} , t _{CLKFALL}	Output clock rise time, Output clock fall time	Rise time measured from –100 mV to +100 mV Fall time measured from +100 mV to –100 mV 1MSPS ≤ Sampling frequency ≤ 160MSPS		0.13		ns
PARALLEL CMOS MODE						
t _{SU}	Data setup time	Data valid ⁽⁷⁾ to zero-crossing of CLKOUT	1.6	2.5		ns
t _H	Data hold time	Zero-crossing of CLKOUT to data becoming invalid ⁽⁷⁾	2.3	2.7		ns
t _{PDI}	Clock propagation delay	Input clock rising edge cross-over to output clock rising edge cross-over	4.5	6.4	8.5	ns
	Output clock duty cycle	Duty cycle of output clock, CLKOUT 1MSPS ≤ Sampling frequency ≤ 160MSPS		46%		
t _{RISE} , t _{FALL}	Data rise time, Data fall time	Rise time measured from 20% to 80% of DRVDD Fall time measured from 80% to 20% of DRVDD 1MSPS ≤ Sampling frequency ≤ 160MSPS		1		ns
t _{CLKRISE} , t _{CLKFALL}	Output clock rise time Output clock fall time	Rise time measured from 20% to 80% of DRVDD Fall time measured from 80% to 20% of DRVDD 1MSPS ≤ Sampling frequency ≤ 160MSPS		1		ns

(7) Data valid refers to a logic high of 1.26 V and a logic low of 0.54 V

8.10 Serial Interface Timing Characteristics⁽¹⁾

See the [Register Initialization](#) section.

PARAMETER		MIN	TYP	MAX	UNIT
f _{SCLK}	SCLK frequency (equal to 1/t _{SCLK})	> DC		20	MHz
t _{SLOADS}	SEN to SCLK setup time	25			ns
t _{SLOADH}	SCLK to SEN hold time	25			ns
t _{DSU}	SDATA setup time	25			ns
t _{DH}	SDATA hold time	25			ns

(1) Typical values at 25°C; minimum and maximum values across the full temperature range: T_{MIN} = –40°C to T_{MAX} = 85°C, AVDD = 1.8 V, and DRVDD = 1.8 V, unless otherwise noted.

8.11 Reset Timing (Only When Serial Interface Is Used)⁽¹⁾

See the [Serial Register Readout](#) section.

PARAMETER	CONDITIONS	MIN	TYP	MAX	UNIT
t ₁	Power-on delay	Delay from AVDD and DRVDD power-up to active RESET pulse			ms
t ₂	Reset pulse width	Active RESET signal pulse width			ns
					1 μs
t ₃	Register write delay	Delay from RESET disable to SEN active			ns

(1) Typical values at 25°C; minimum and maximum values across the full temperature range: T_{MIN} = –40°C to T_{MAX} = 85°C, unless otherwise noted.

Table 1. LVDS Timings at Lower Sampling Frequencies

SAMPLING FREQUENCY (MSPS)	SETUP TIME (ns)			HOLD TIME (ns)			t_{PDI} : CLOCK PROPAGATION DELAY (ns)		
	MIN	TYP	MAX	MIN	TYP	MAX	MIN	TYP	MAX
65	5.9	6.6		0.35	0.6		5	6.1	7.5
80	4.5	5.2		0.35	0.6		5	6.1	7.5
105	3.1	3.6		0.35	0.6		5	6.1	7.5
125	2.3	2.9		0.35	0.6		5	6.1	7.5
150	1.7	2.2		0.35	0.6		5	6.1	7.5

Table 2. CMOS Timings at Lower Sampling Frequencies

SAMPLING FREQUENCY (MSPS)	TIMINGS SPECIFIED WITH RESPECT TO CLKOUT								
	SETUP TIME (ns)			HOLD TIME (ns)			t_{PDI} : CLOCK PROPAGATION DELAY (ns)		
	MIN	TYP	MAX	MIN	TYP	MAX	MIN	TYP	MAX
65	6.1	7.2		6.7	7.1		4.5	6.4	8.5
80	4.7	5.8		5.3	5.8		4.5	6.4	8.5
105	3.4	4.3		3.8	4.3		4.5	6.4	8.5
125	2.7	3.6		3.1	3.6		4.5	6.4	8.5
150	1.9	2.8		2.5	2.9		4.5	6.4	8.5

Table 3. High-Performance Modes⁽¹⁾⁽²⁾

PARAMETER	DESCRIPTION
High-performance mode	Set the HIGH PERF MODE register bit to obtain best performance across sample clock and input signal frequencies. See Figure 5 . Register address = 03h, data = 03h
High-frequency mode	Set the HIGH FREQ MODE CH A and HIGH FREQ MODE CH B register bits for high input signal frequencies greater than 200 MHz. See Figure 5 . Register address = 4Ah, data = 01h Register address = 58h, data = 01h

- (1) It is recommended to use these modes to obtain best performance.
- (2) See the [Serial Interface Configuration](#) section for details on register programming.

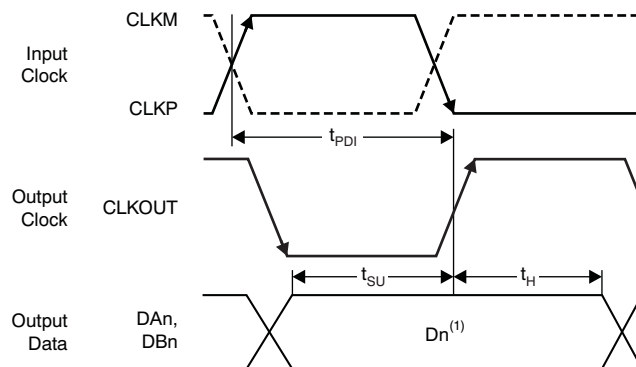

- (1) Dn = bits D0, D1, D2, etc. of channels A and B.

Figure 1. CMOS Interface Timing Diagram

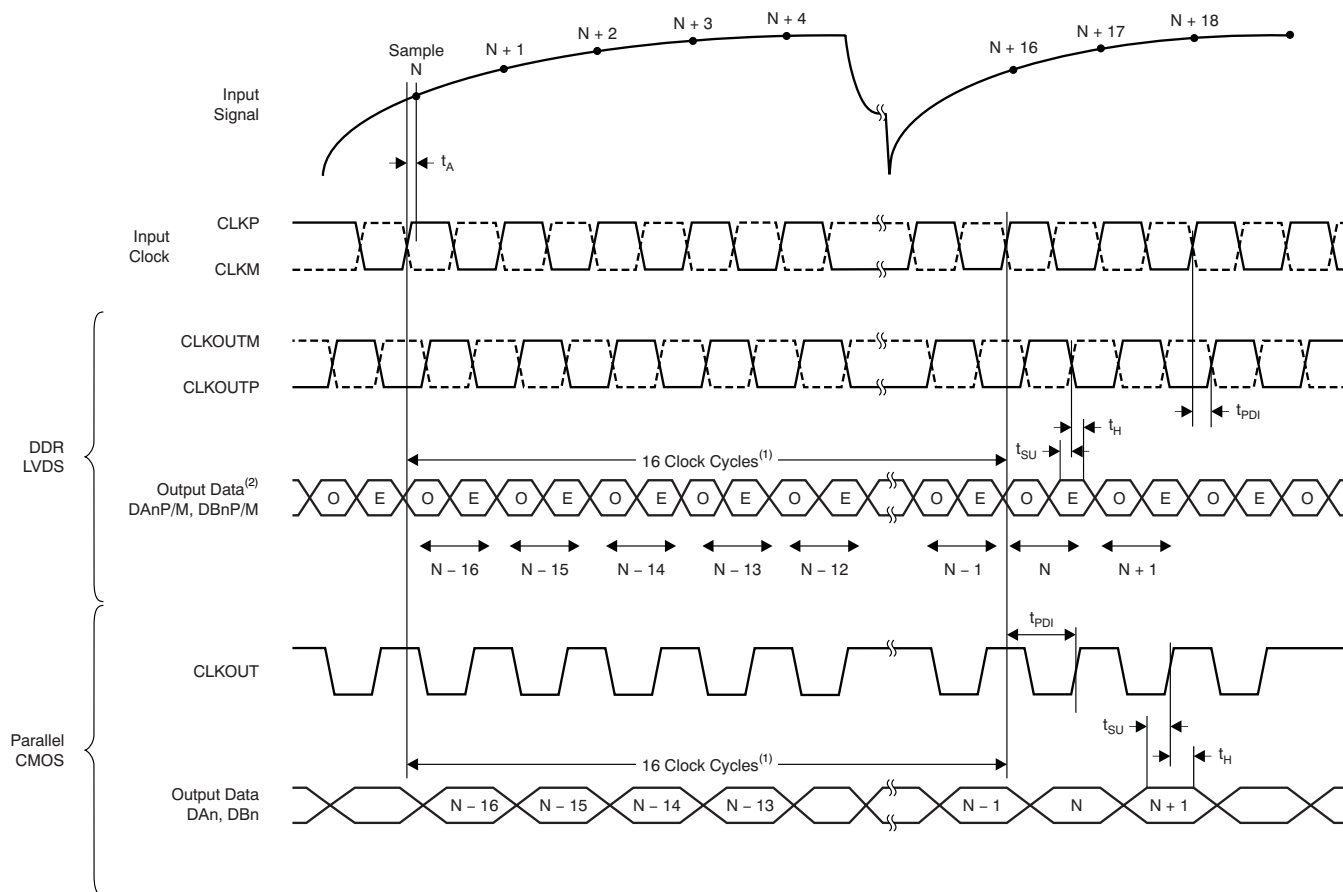

- (1) ADC latency after reset. At higher sampling frequencies, t_{PDI} is greater than one clock cycle, which then makes the overall latency = ADC latency + 1.
- (2) E = even bits (D0, D2, D4, etc.); O = odd bits (D1, D3, D5, etc.).

Figure 2. Latency Timing Diagram

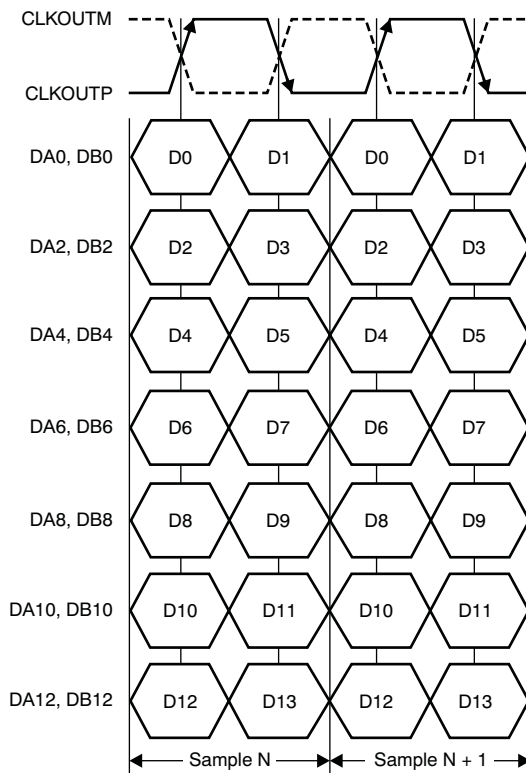

Figure 3. ADS4246/45/42 LVDS Interface Timing Diagram

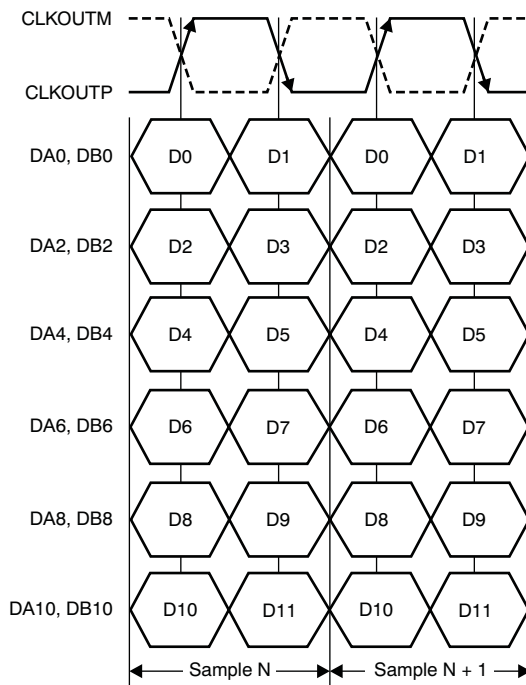
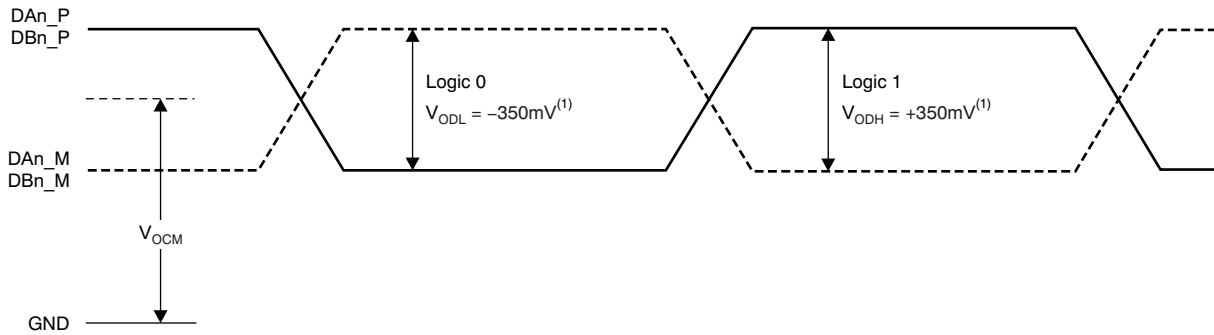

Figure 4. ADS4226/25/22 LVDS Interface Timing Diagram



(1) With external 100- Ω termination.

Figure 5. LVDS Output Voltage Levels

8.12 Typical Characteristics

8.12.1 ADS4246

At $T_A = 25^\circ\text{C}$, $AVDD = 1.8\text{ V}$, $DRVDD = 1.8\text{ V}$, maximum rated sampling frequency, sine wave input clock, 1.5-V_{PP} differential clock amplitude, 50% clock duty cycle, -1 dBFS differential analog input, High-Performance Mode disabled, 0-dB gain, DDR LVDS output interface, and 32k point FFT, unless otherwise noted.

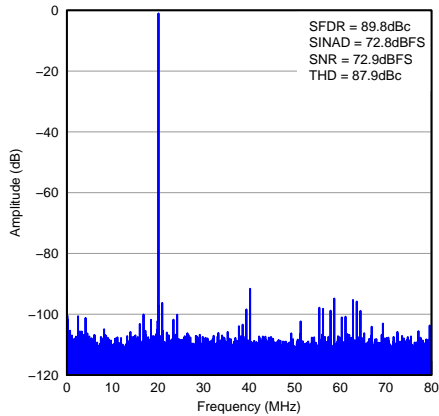

Figure 6. FFT for 20-MHz Input Signal

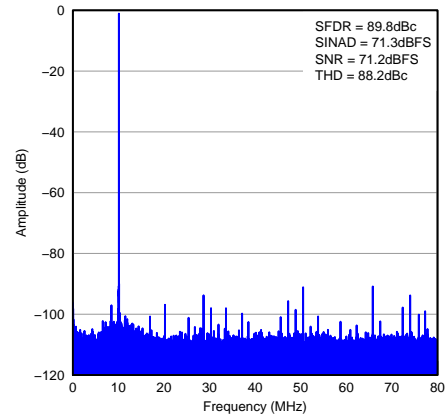

Figure 7. FFT for 170-MHz Input Signal

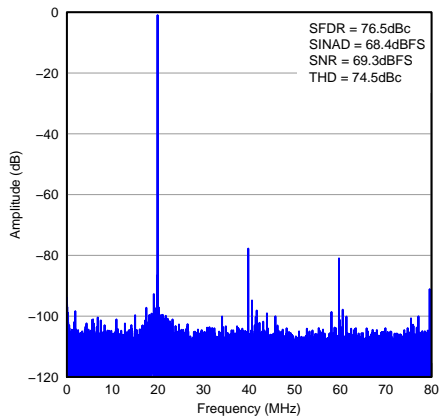

Figure 8. FFT for 300-MHz Input Signal

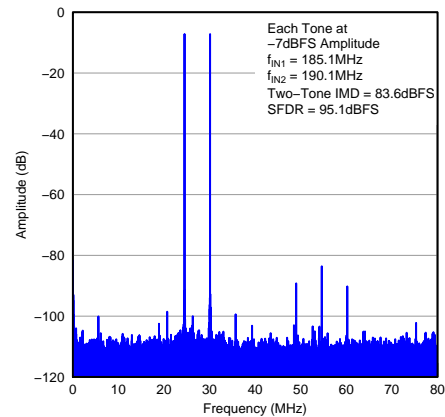

Figure 9. FFT for Two-tone Input Signal

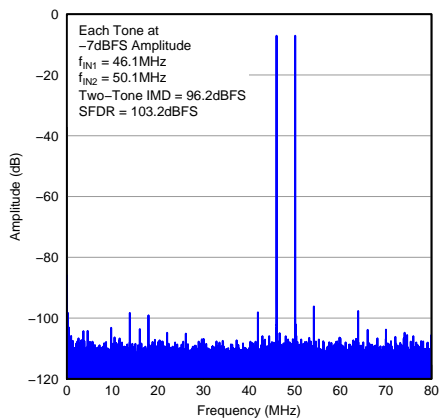

Figure 10. FFT for Two-Tone Input Signal

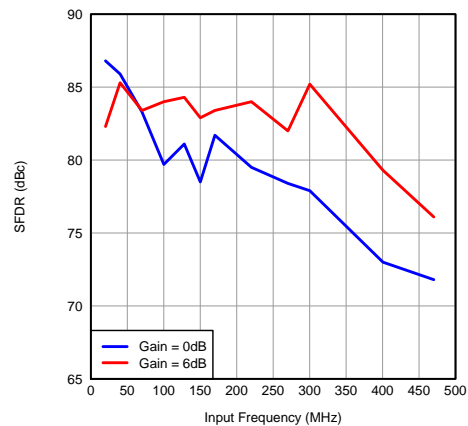

Figure 11. SFDR vs Input Frequency

ADS4246 (continued)

At $T_A = 25^\circ\text{C}$, $AVDD = 1.8\text{ V}$, $DRVDD = 1.8\text{ V}$, maximum rated sampling frequency, sine wave input clock, 1.5-V_{PP} differential clock amplitude, 50% clock duty cycle, -1 dBFS differential analog input, High-Performance Mode disabled, 0-dB gain, DDR LVDS output interface, and 32k point FFT, unless otherwise noted.

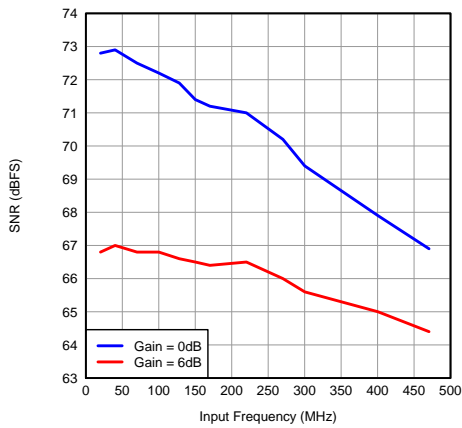

Figure 12. SNR vs Input Frequency

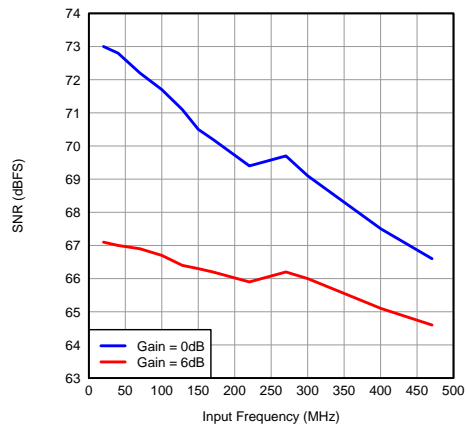

Figure 13. SNR vs Input Frequency (CMOS)

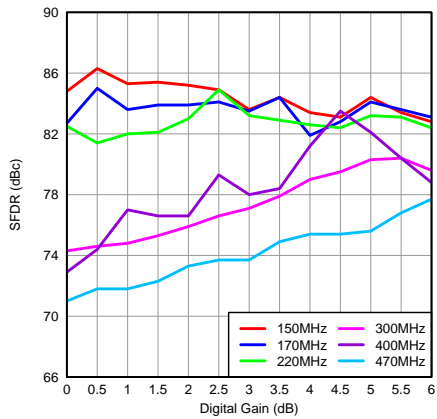

Figure 14. SFDR vs Gain and Input Frequency

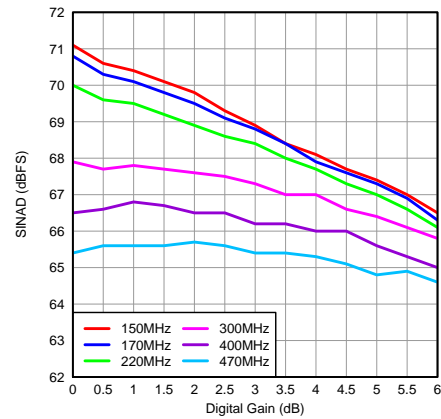

Figure 15. SINAD vs Gain and Input Frequency

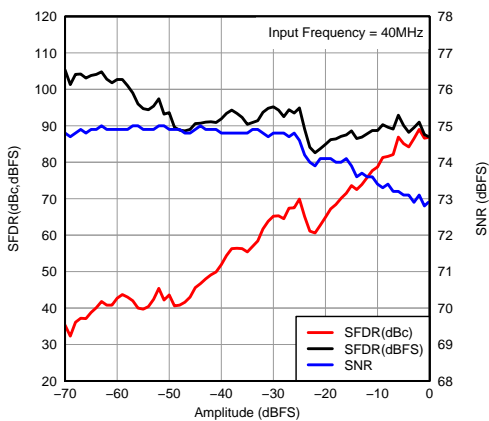

Figure 16. Performance vs Input Amplitude

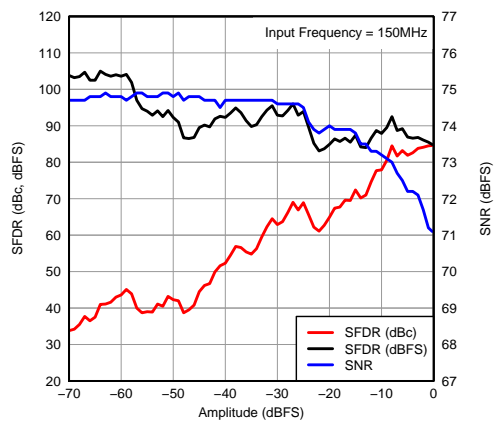

Figure 17. Performance vs Input Amplitude

ADS4246 (continued)

At $T_A = 25^\circ\text{C}$, $AVDD = 1.8\text{ V}$, $DRVDD = 1.8\text{ V}$, maximum rated sampling frequency, sine wave input clock, 1.5-V_{PP} differential clock amplitude, 50% clock duty cycle, -1 dBFS differential analog input, High-Performance Mode disabled, 0-dB gain, DDR LVDS output interface, and 32k point FFT, unless otherwise noted.

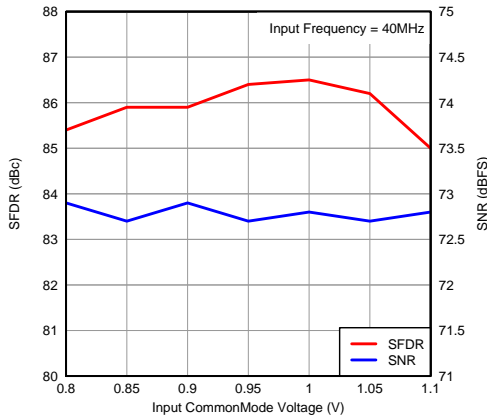

Figure 18. Performance vs Input Common-Mode Voltage

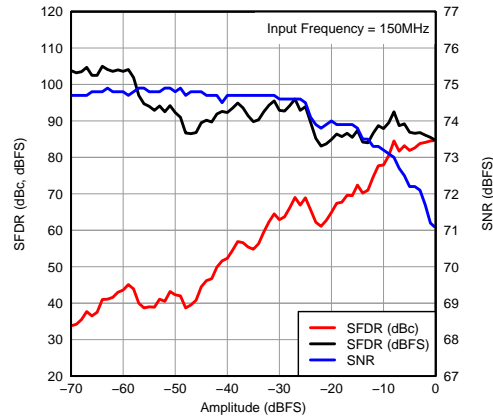

Figure 19. Performance vs Input Common-Mode Voltage

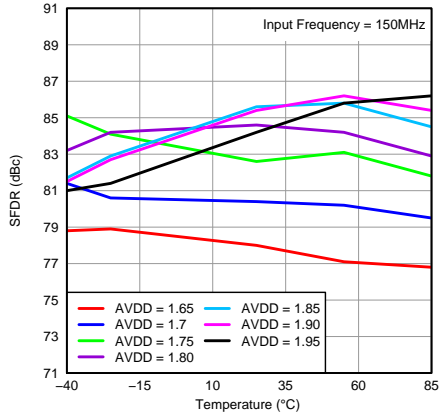

Figure 20. SFDR vs Temperature and AVDD Supply

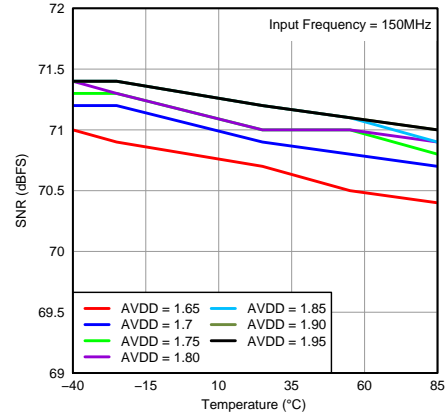

Figure 21. SNR vs Temperature and AVDD Supply

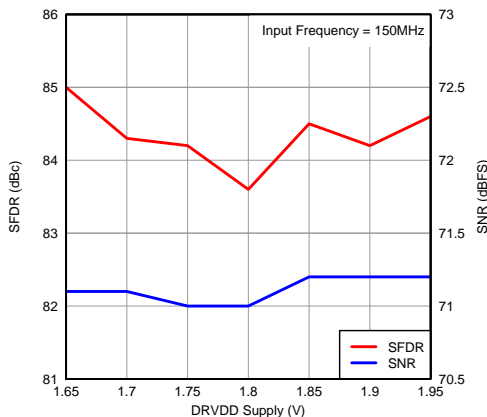

Figure 22. Performance vs DRVDD Supply Voltage

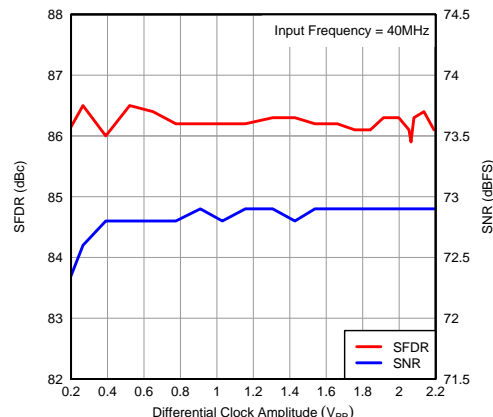

Figure 23. Performance vs Input Clock Amplitude

ADS4246 (continued)

At $T_A = 25^\circ\text{C}$, $AVDD = 1.8\text{ V}$, $DRVDD = 1.8\text{ V}$, maximum rated sampling frequency, sine wave input clock, 1.5-V_{PP} differential clock amplitude, 50% clock duty cycle, -1 dBFS differential analog input, High-Performance Mode disabled, 0-dB gain, DDR LVDS output interface, and 32k point FFT, unless otherwise noted.

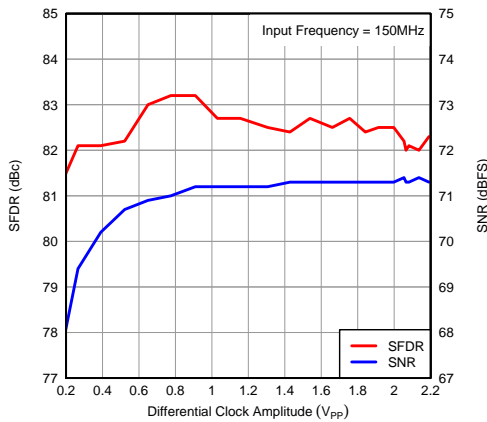

Figure 24. Performance vs Input Clock Amplitude

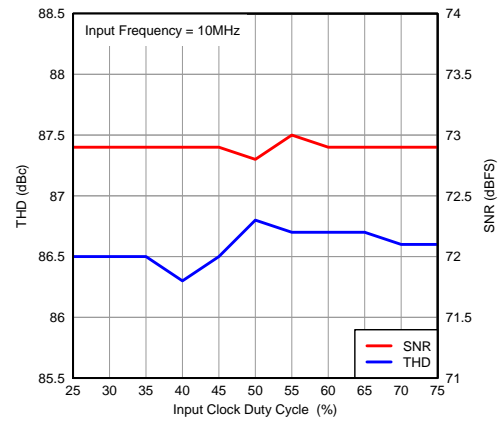

Figure 25. Performance vs Input Clock Duty Cycle

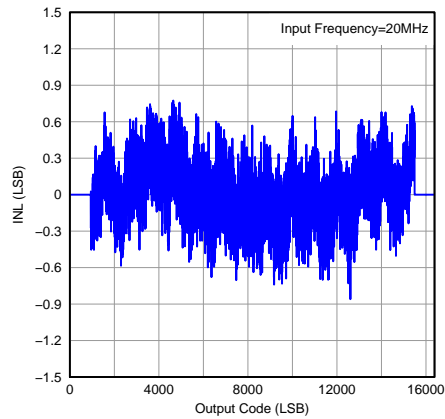

Figure 26. Integrated Nonlinearity

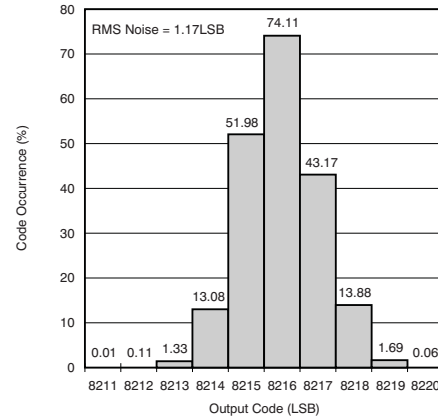

Figure 27. Output Noise Histogram (With Inputs Shorted to VCM)

8.12.2 ADS4245

At $T_A = 25^\circ\text{C}$, $AVDD = 1.8\text{ V}$, $DRVDD = 1.8\text{ V}$, maximum rated sampling frequency, sine wave input clock, 1.5-V_{PP} differential clock amplitude, 50% clock duty cycle, -1 dBFS differential analog input, High-Performance Mode disabled, 0-dB gain, DDR LVDS output interface, and 32k point FFT, unless otherwise noted.

ADS4245 (continued)

At $T_A = 25^\circ\text{C}$, $AVDD = 1.8\text{ V}$, $DRVDD = 1.8\text{ V}$, maximum rated sampling frequency, sine wave input clock, 1.5- V_{PP} differential clock amplitude, 50% clock duty cycle, -1 dBFS differential analog input, High-Performance Mode disabled, 0-dB gain, DDR LVDS output interface, and 32k point FFT, unless otherwise noted.

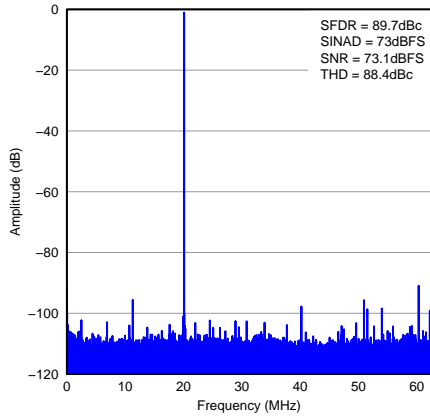

Figure 28. FFT for 20-MHz Input Signal

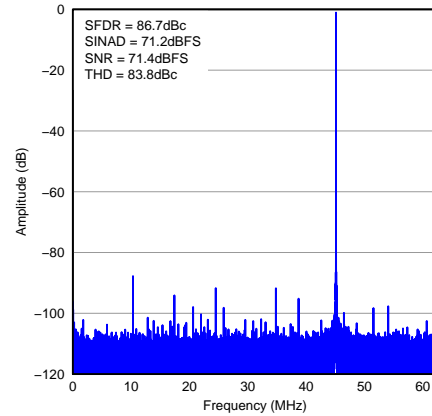

Figure 29. FFT for 170-MHz Input Signal

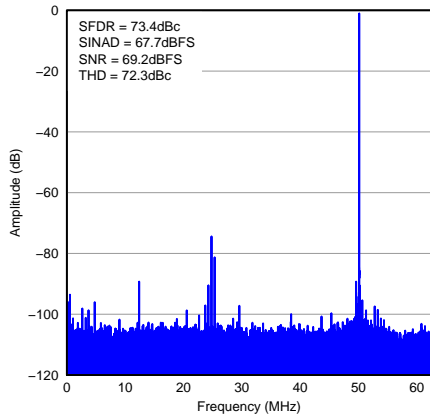

Figure 30. FFT for 300-MHz Input Signal

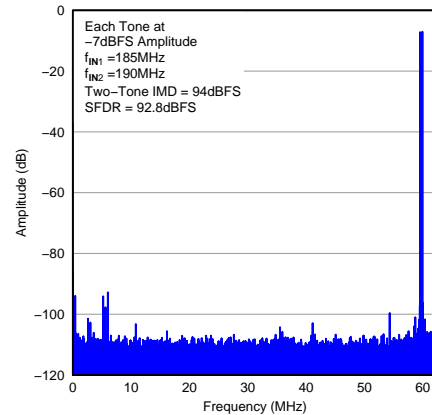

Figure 31. FFT for Two-Tone Input Signal

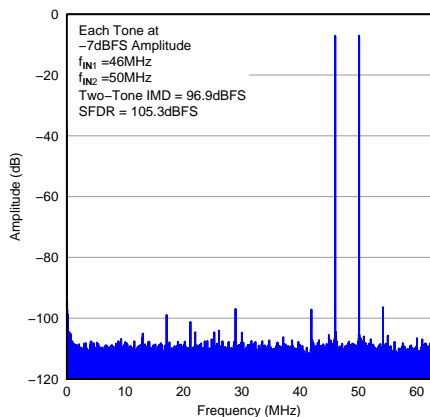

Figure 32. FFT for Two-Tone Input Signal

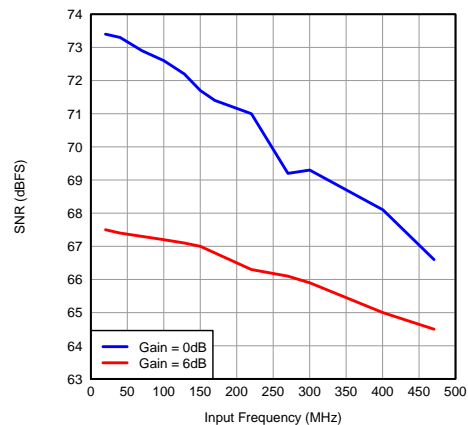

Figure 33. SNR vs Input Frequency

ADS4245 (continued)

At $T_A = 25^\circ\text{C}$, $AVDD = 1.8\text{ V}$, $DRVDD = 1.8\text{ V}$, maximum rated sampling frequency, sine wave input clock, 1.5-V_{PP} differential clock amplitude, 50% clock duty cycle, -1 dBFS differential analog input, High-Performance Mode disabled, 0-dB gain, DDR LVDS output interface, and 32k point FFT, unless otherwise noted.

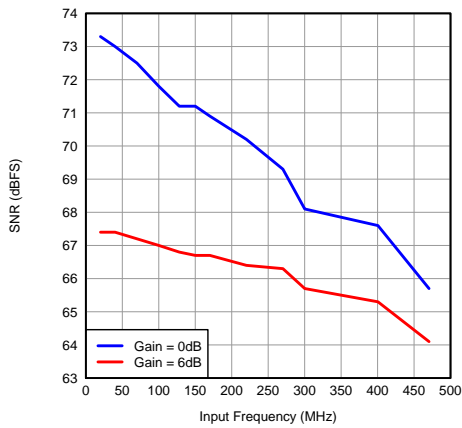

Figure 34. SNR vs Input Frequency (CMOS)

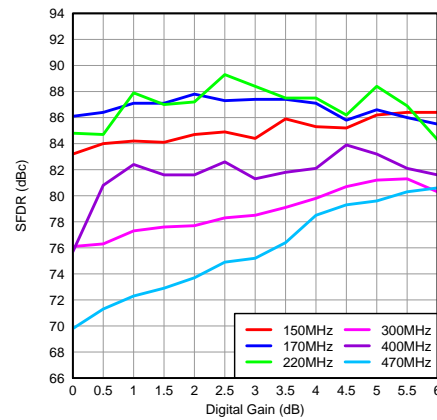

Figure 35. SFDR vs Gain and Input Frequency

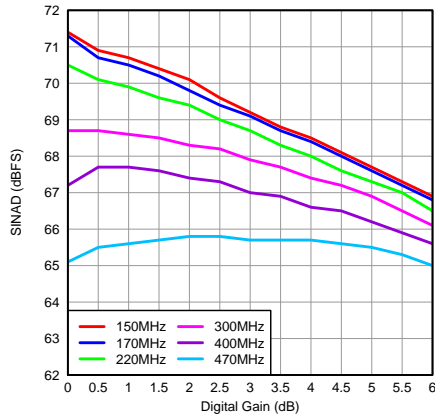

Figure 36. SINAD vs Gain and Input Frequency

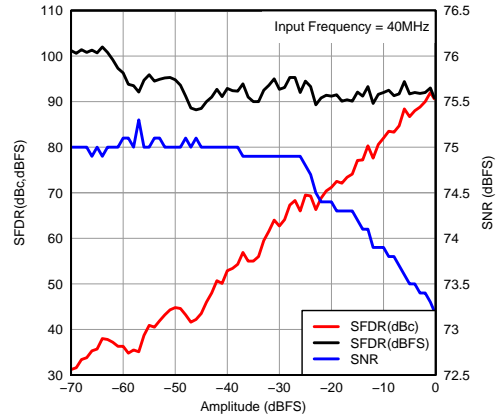

Figure 37. Performance vs Input Amplitude

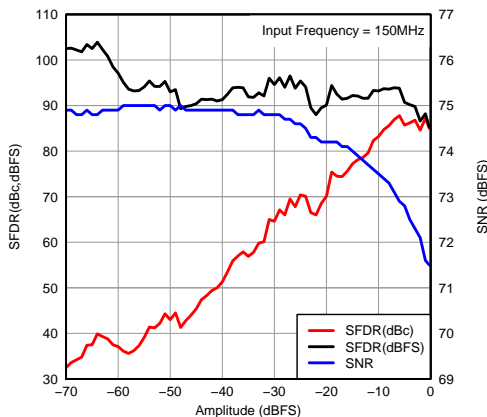

Figure 38. Performance vs Input Amplitude

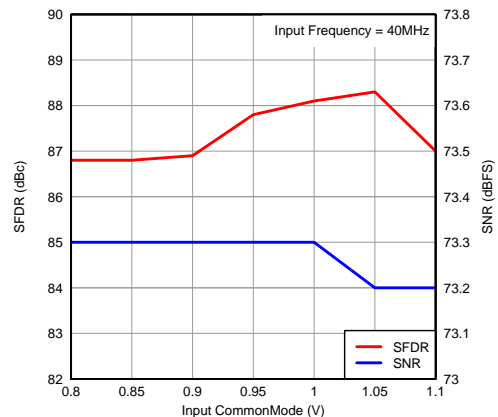

Figure 39. Performance vs Input Common-Mode Voltage

ADS4245 (continued)

At $T_A = 25^\circ\text{C}$, $AVDD = 1.8\text{ V}$, $DRVDD = 1.8\text{ V}$, maximum rated sampling frequency, sine wave input clock, 1.5-V_{pp} differential clock amplitude, 50% clock duty cycle, -1 dBFS differential analog input, High-Performance Mode disabled, 0-dB gain, DDR LVDS output interface, and 32k point FFT, unless otherwise noted.

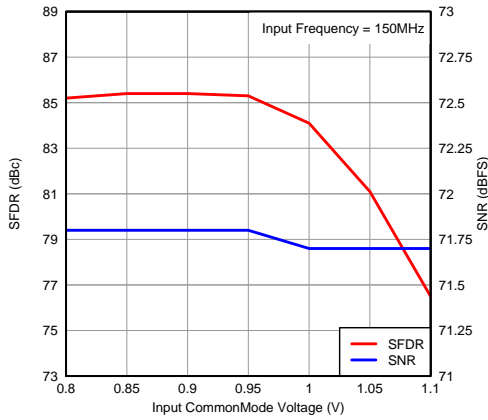

Figure 40. Performance vs Input Common-Mode Voltage

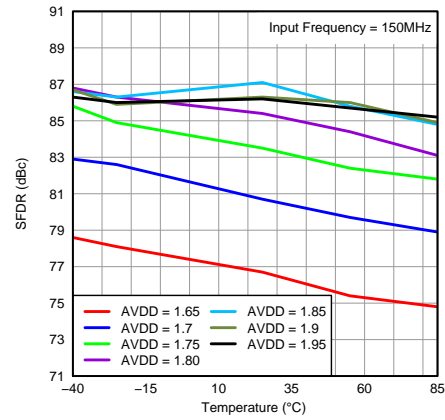

Figure 41. SFDR vs Temperature and AVDD Supply

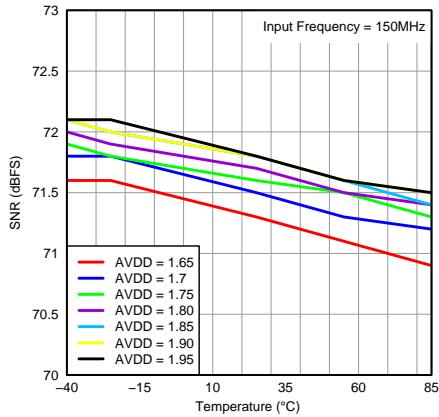

Figure 42. SNR vs Temperature and AVDD Supply

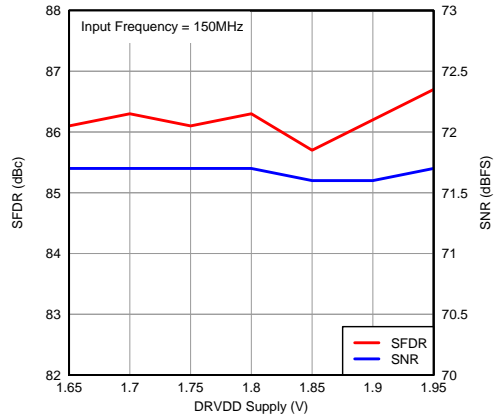

Figure 43. Performance vs DRVDD Supply Voltage

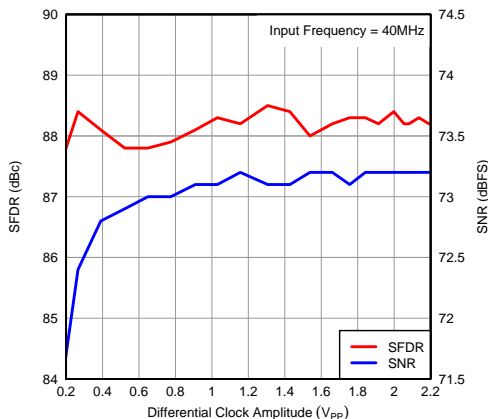

Figure 44. Performance vs Input Clock Amplitude

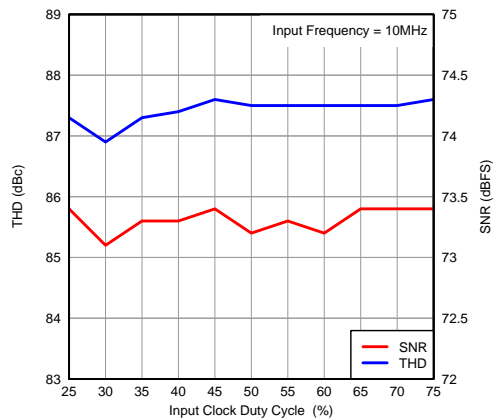
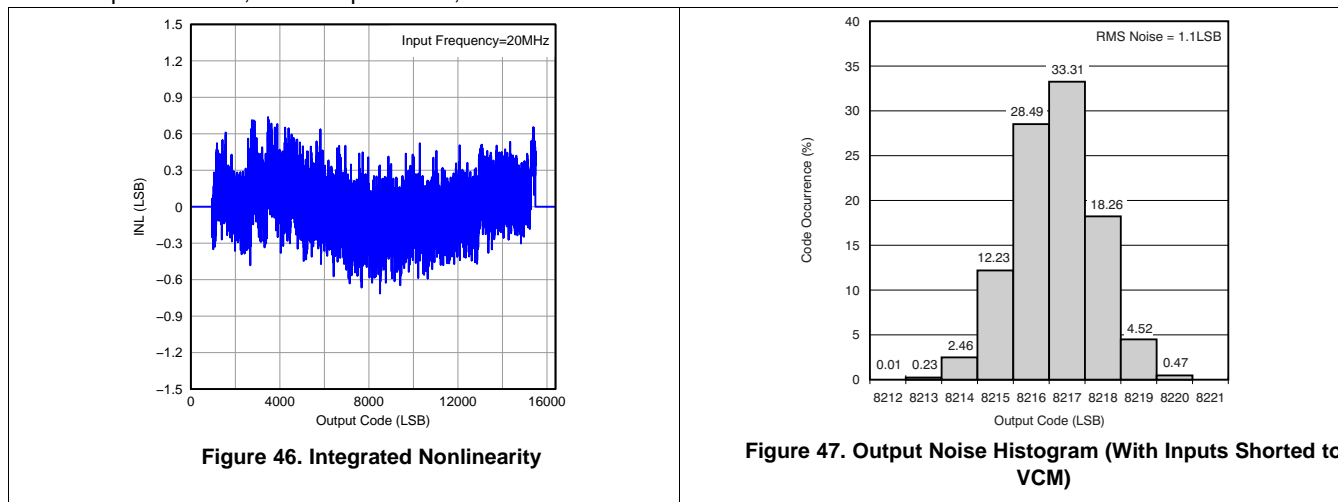

Figure 45. Performance vs Input Clock Duty Cycle

ADS4245 (continued)

At $T_A = 25^\circ\text{C}$, $AVDD = 1.8\text{ V}$, $DRVDD = 1.8\text{ V}$, maximum rated sampling frequency, sine wave input clock, 1.5-V_{PP} differential clock amplitude, 50% clock duty cycle, -1 dBFS differential analog input, High-Performance Mode disabled, 0-dB gain, DDR LVDS output interface, and 32k point FFT, unless otherwise noted.



8.12.3 ADS4242

At $T_A = 25^\circ\text{C}$, $AVDD = 1.8\text{ V}$, $DRVDD = 1.8\text{ V}$, maximum rated sampling frequency, sine wave input clock, 1.5-V_{PP} differential clock amplitude, 50% clock duty cycle, -1 dBFS differential analog input, High-Performance Mode disabled, 0-dB gain, DDR LVDS output interface, and 32k point FFT, unless otherwise noted.

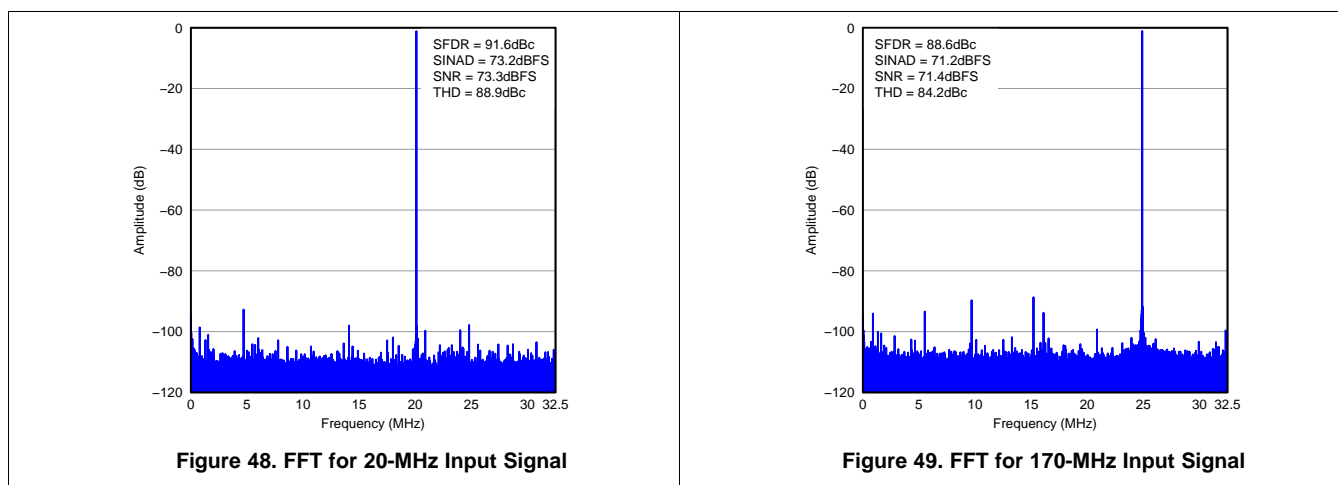

ADS4242 (continued)

At $T_A = 25^\circ\text{C}$, $AVDD = 1.8\text{ V}$, $DRVDD = 1.8\text{ V}$, maximum rated sampling frequency, sine wave input clock, 1.5-V_{PP} differential clock amplitude, 50% clock duty cycle, -1 dBFS differential analog input, High-Performance Mode disabled, 0-dB gain, DDR LVDS output interface, and 32k point FFT, unless otherwise noted.

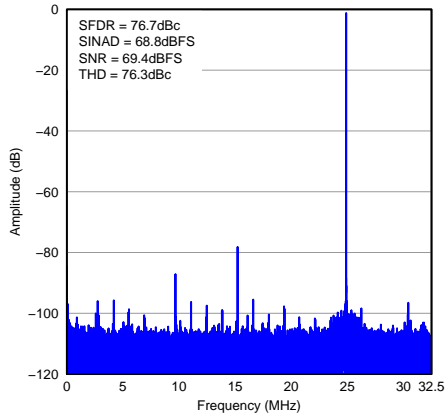

Figure 50. FFT for 300-MHz Input Signal

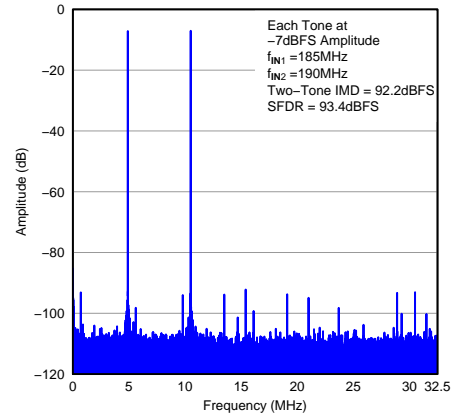

Figure 51. FFT for Two-Tone Input Signal

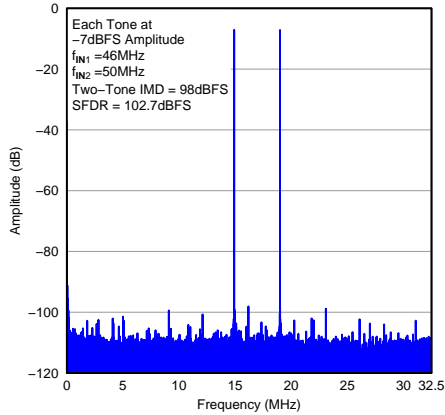

Figure 52. FFT for Two-Tone Input Signal

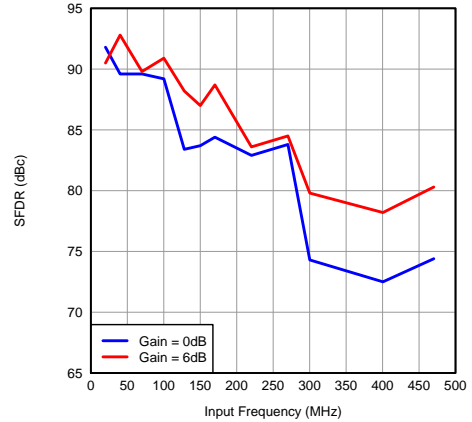

Figure 53. SFDR vs Input Frequency

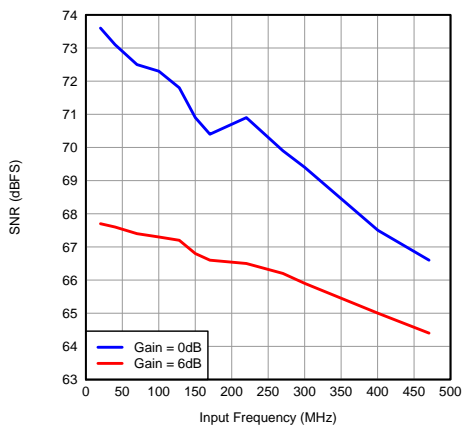

Figure 54. SNR vs Input Frequency

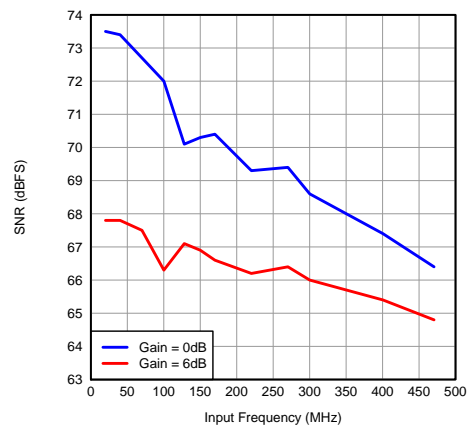

Figure 55. SNR vs Input Frequency (CMOS)

ADS4242 (continued)

At $T_A = 25^\circ\text{C}$, $AV_{DD} = 1.8\text{ V}$, $DRV_{DD} = 1.8\text{ V}$, maximum rated sampling frequency, sine wave input clock, 1.5-V_{PP} differential clock amplitude, 50% clock duty cycle, -1 dBFS differential analog input, High-Performance Mode disabled, 0-dB gain, DDR LVDS output interface, and 32k point FFT, unless otherwise noted.

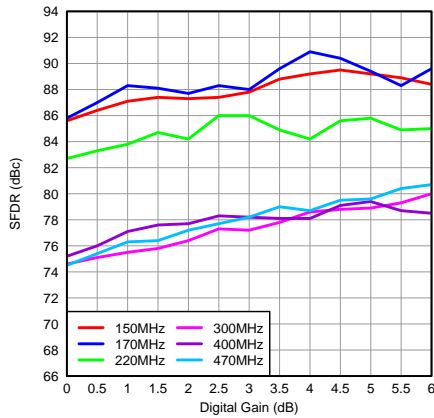

Figure 56. SFDR vs Gain and Input Frequency

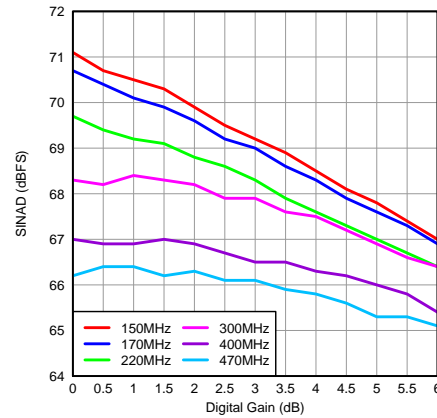

Figure 57. SINAD vs Gain and Input Frequency

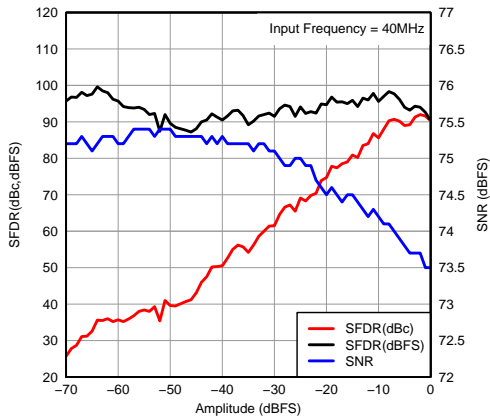

Figure 58. Performance vs Input Amplitude

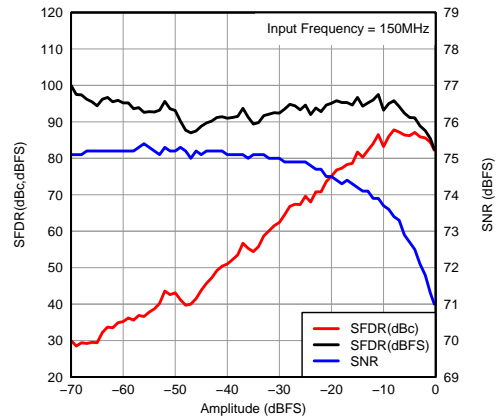

Figure 59. Performance vs Input Amplitude

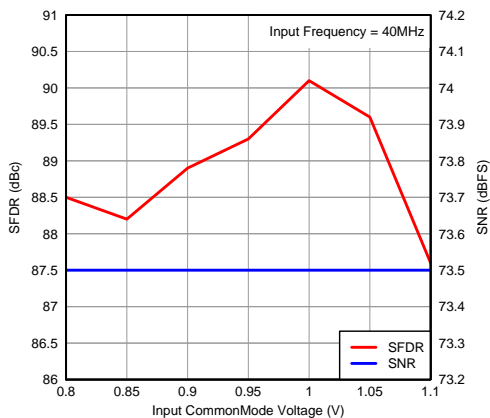

Figure 60. Performance vs Input Common-Mode Voltage

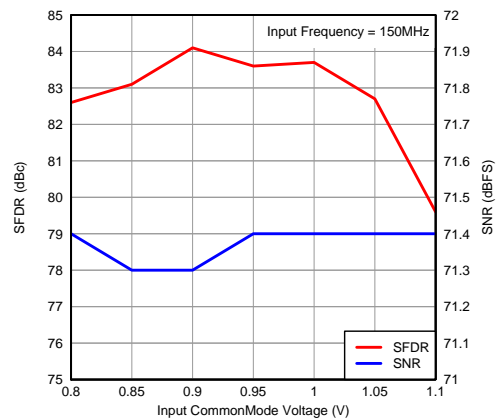
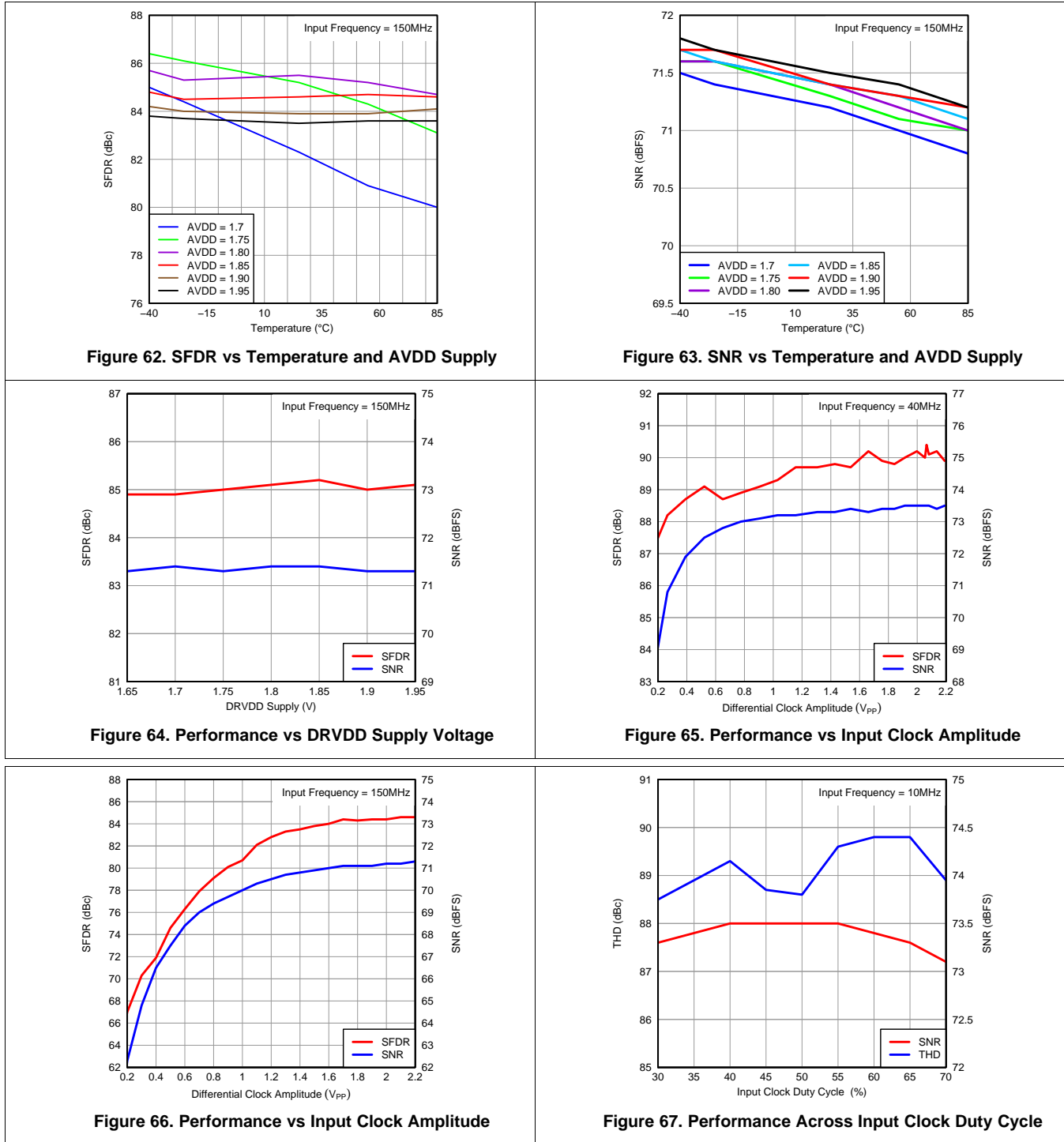

Figure 61. Performance vs Input Common-Mode Voltage

ADS4242 (continued)

At $T_A = 25^\circ\text{C}$, $AVDD = 1.8\text{ V}$, $DRVDD = 1.8\text{ V}$, maximum rated sampling frequency, sine wave input clock, $1.5\text{-}V_{PP}$ differential clock amplitude, 50% clock duty cycle, -1 dBFS differential analog input, High-Performance Mode disabled, 0-dB gain, DDR LVDS output interface, and 32k point FFT, unless otherwise noted.



ADS4242 (continued)

At $T_A = 25^\circ\text{C}$, $AVDD = 1.8\text{ V}$, $DRVDD = 1.8\text{ V}$, maximum rated sampling frequency, sine wave input clock, 1.5-V_{PP} differential clock amplitude, 50% clock duty cycle, -1 dBFS differential analog input, High-Performance Mode disabled, 0-dB gain, DDR LVDS output interface, and 32k point FFT, unless otherwise noted.

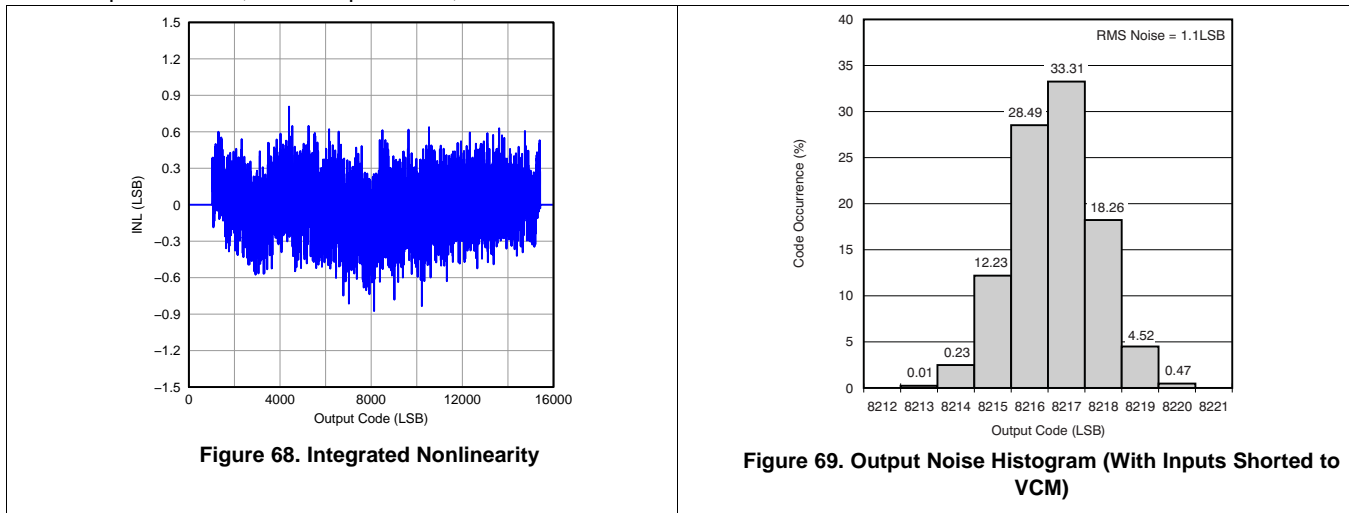

8.12.4 ADS4226

At $T_A = 25^\circ\text{C}$, $AVDD = 1.8\text{ V}$, $DRVDD = 1.8\text{ V}$, maximum rated sampling frequency, sine wave input clock, 1.5-V_{PP} differential clock amplitude, 50% clock duty cycle, -1 dBFS differential analog input, High-Performance Mode disabled, 0-dB gain, DDR LVDS output interface, and 32k point FFT, unless otherwise noted.

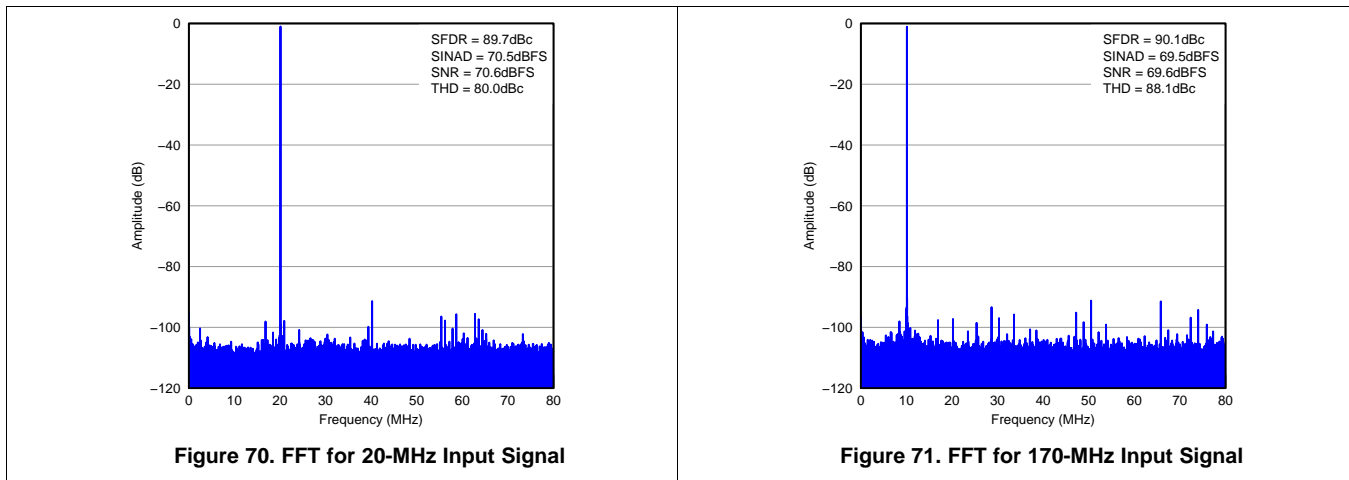

ADS4226 (continued)

At $T_A = 25^\circ\text{C}$, $AVDD = 1.8\text{ V}$, $DRVDD = 1.8\text{ V}$, maximum rated sampling frequency, sine wave input clock, 1.5-V_{pp} differential clock amplitude, 50% clock duty cycle, -1 dBFS differential analog input, High-Performance Mode disabled, 0-dB gain, DDR LVDS output interface, and 32k point FFT, unless otherwise noted.

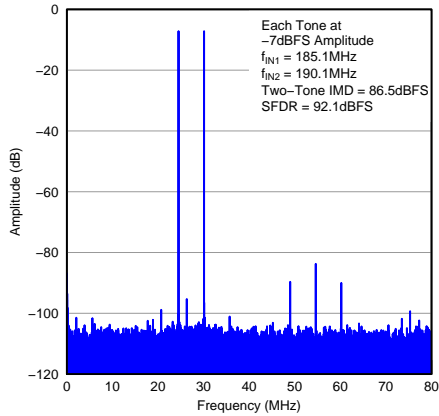

Figure 72. FFT for Two-Tone Input Signal

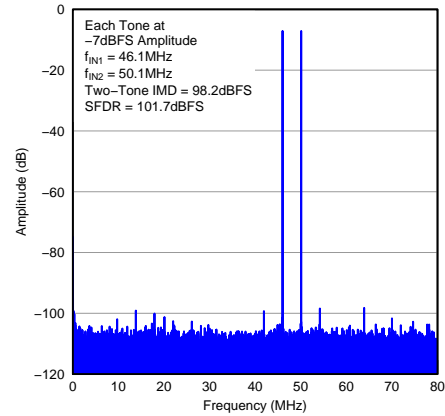

Figure 73. FFT for Two-Tone Input Signal

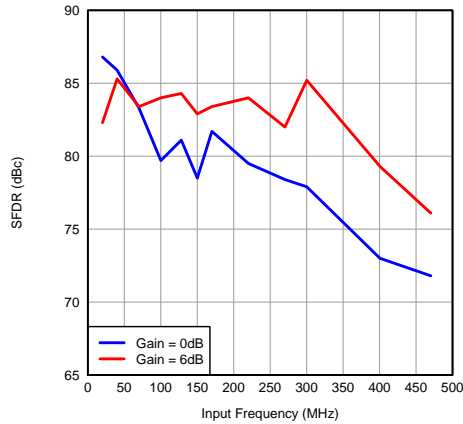

Figure 74. SFDR vs Input Frequency

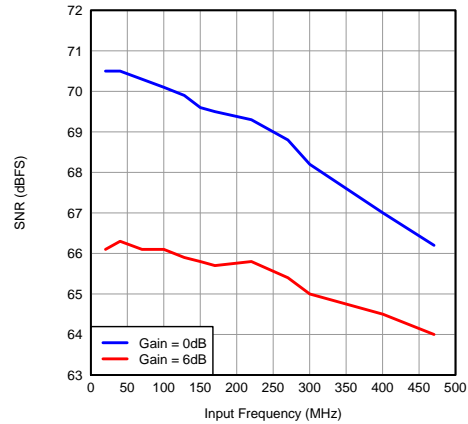

Figure 75. SNR vs Input Frequency

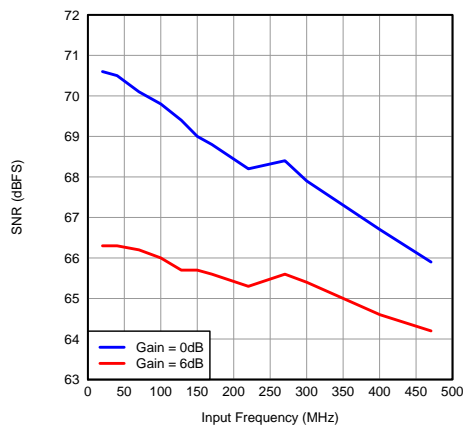

Figure 76. SNR vs Input Frequency (CMOS)

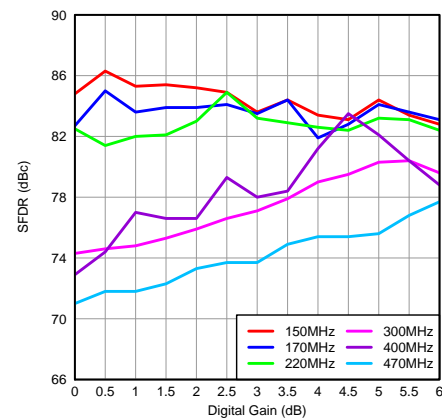

Figure 77. SFDR vs Gain and Input Frequency

ADS4226 (continued)

At $T_A = 25^\circ\text{C}$, $AVDD = 1.8\text{ V}$, $DRVDD = 1.8\text{ V}$, maximum rated sampling frequency, sine wave input clock, 1.5-V_{PP} differential clock amplitude, 50% clock duty cycle, -1 dBFS differential analog input, High-Performance Mode disabled, 0-dB gain, DDR LVDS output interface, and 32k point FFT, unless otherwise noted.

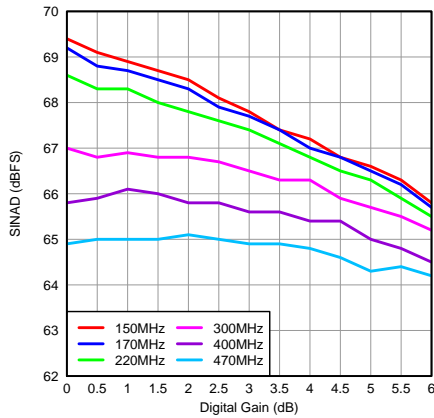

Figure 78. SINAD vs Gain and Input Frequency

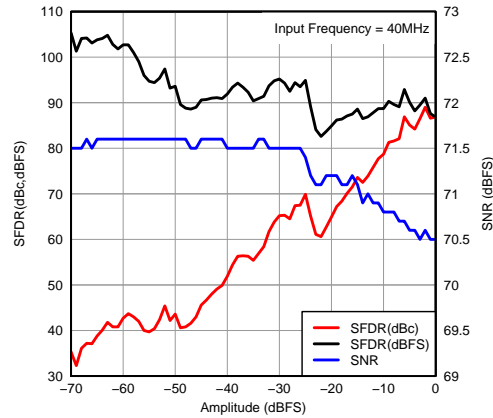

Figure 79. Performance vs Input Amplitude

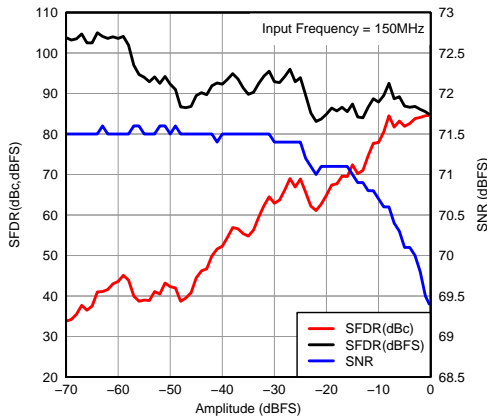

Figure 80. Performance vs Input Amplitude

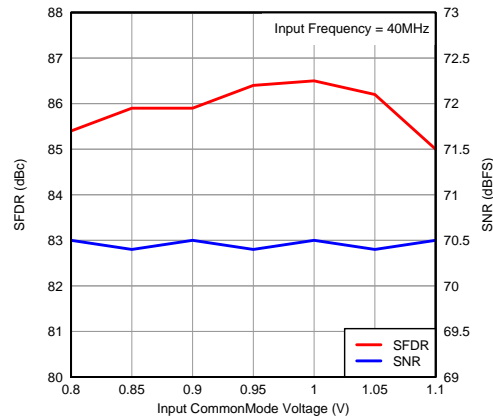

Figure 81. Performance vs Input Common-Mode Voltage

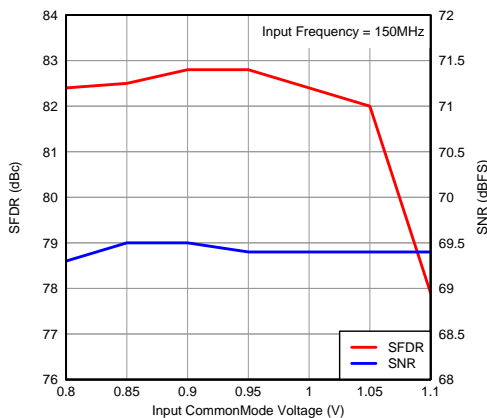

Figure 82. Performance vs Input Common-Mode Voltage

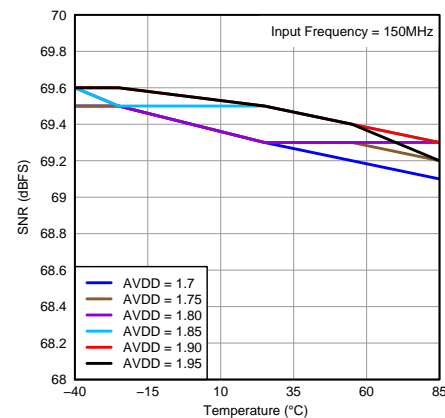
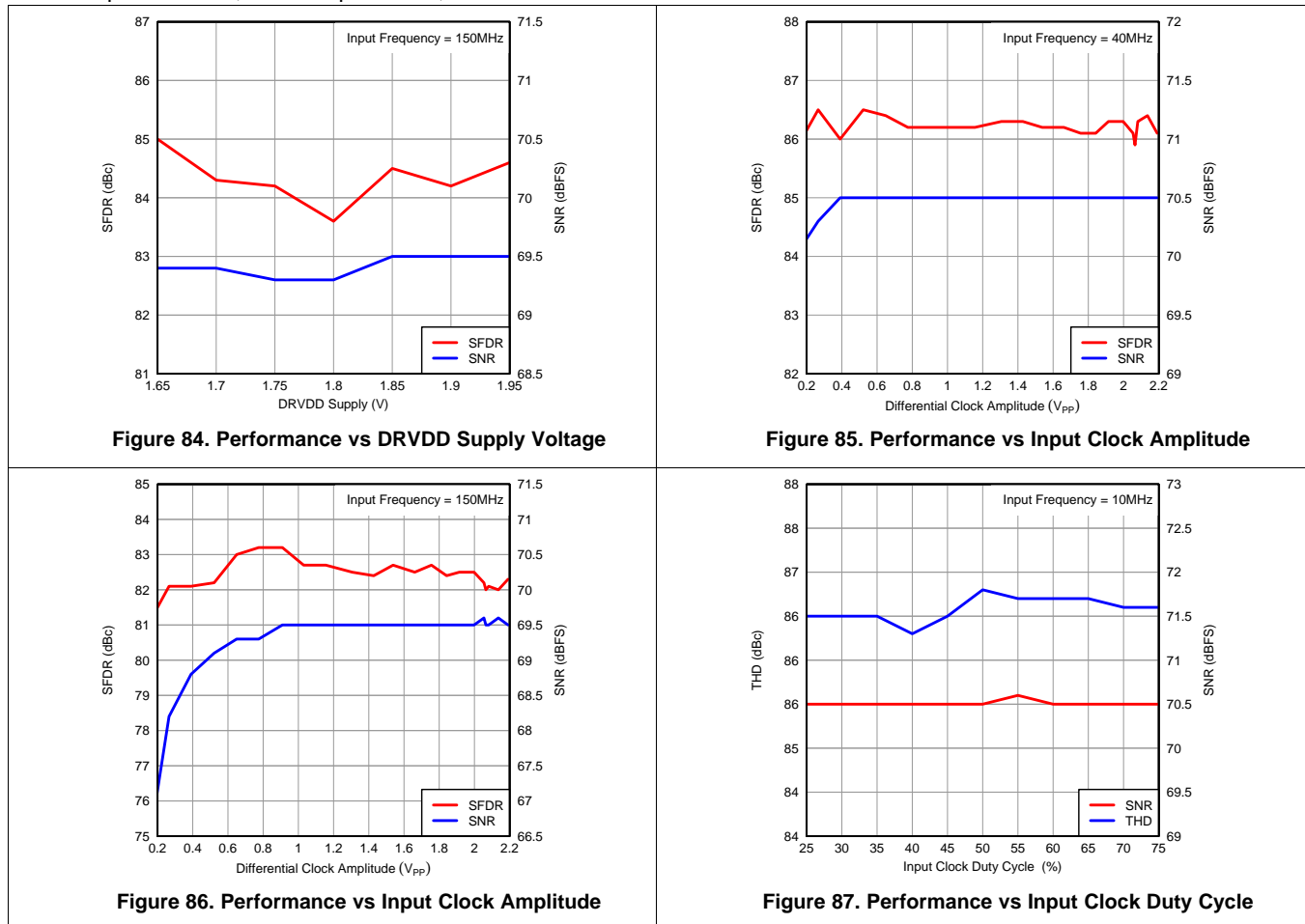

Figure 83. SNR vs Temperature and AVDD Supply

ADS4226 (continued)

At $T_A = 25^\circ\text{C}$, $AVDD = 1.8\text{ V}$, $DRVDD = 1.8\text{ V}$, maximum rated sampling frequency, sine wave input clock, $1.5\text{-}V_{PP}$ differential clock amplitude, 50% clock duty cycle, -1 dBFS differential analog input, High-Performance Mode disabled, 0-dB gain, DDR LVDS output interface, and 32k point FFT, unless otherwise noted.



8.12.5 ADS4225

At $T_A = 25^\circ\text{C}$, $AVDD = 1.8\text{ V}$, $DRVDD = 1.8\text{ V}$, maximum rated sampling frequency, sine wave input clock, $1.5\text{-}V_{PP}$ differential clock amplitude, 50% clock duty cycle, -1 dBFS differential analog input, High-Performance Mode disabled, 0-dB gain, DDR LVDS output interface, and 32k point FFT, unless otherwise noted.

ADS4225 (continued)

At $T_A = 25^\circ\text{C}$, $AVDD = 1.8\text{ V}$, $DRVDD = 1.8\text{ V}$, maximum rated sampling frequency, sine wave input clock, 1.5-V_{PP} differential clock amplitude, 50% clock duty cycle, -1 dBFS differential analog input, High-Performance Mode disabled, 0-dB gain, DDR LVDS output interface, and 32k point FFT, unless otherwise noted.

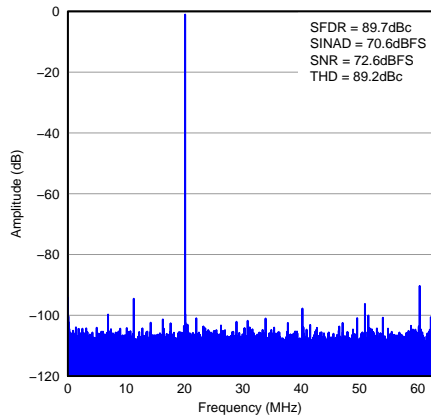

Figure 88. FFT for 20-MHz Input Signal

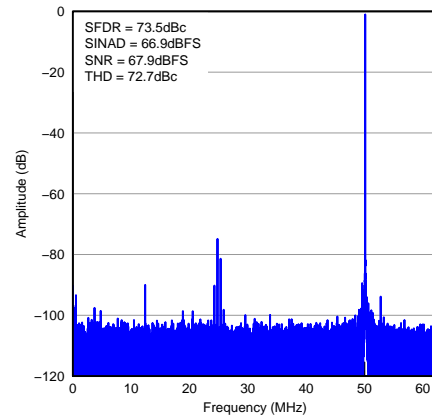

Figure 89. FFT for 300-MHz Input Signal

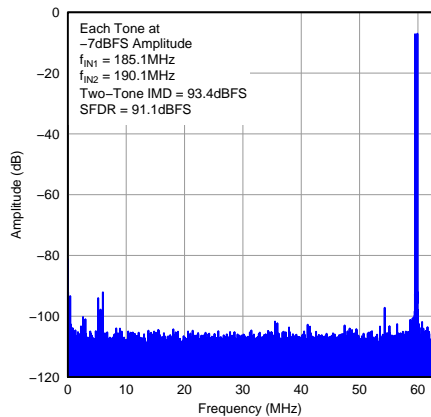

Figure 90. FFT for Two-Tone Input Signal

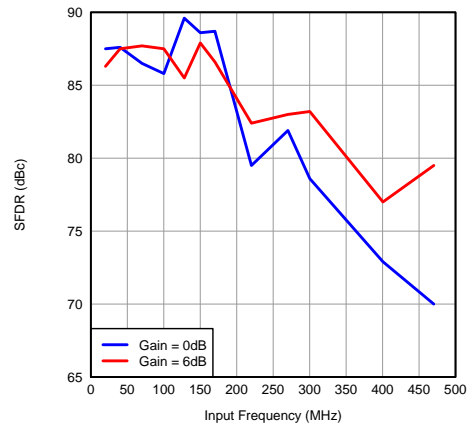

Figure 91. SFDR vs Input Frequency

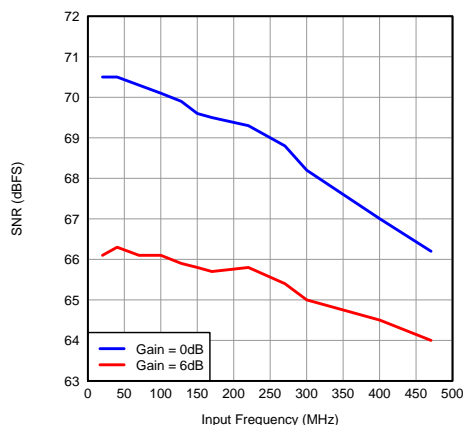

Figure 92. SNR vs Input Frequency

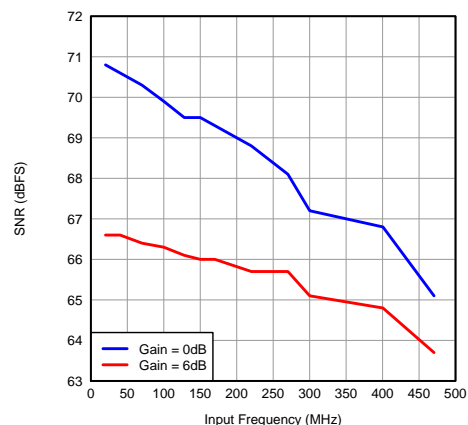

Figure 93. SNR vs Input Frequency (CMOS)

ADS4225 (continued)

At $T_A = 25^\circ\text{C}$, $AVDD = 1.8\text{ V}$, $DRVDD = 1.8\text{ V}$, maximum rated sampling frequency, sine wave input clock, 1.5-V_{PP} differential clock amplitude, 50% clock duty cycle, -1 dBFS differential analog input, High-Performance Mode disabled, 0-dB gain, DDR LVDS output interface, and 32k point FFT, unless otherwise noted.

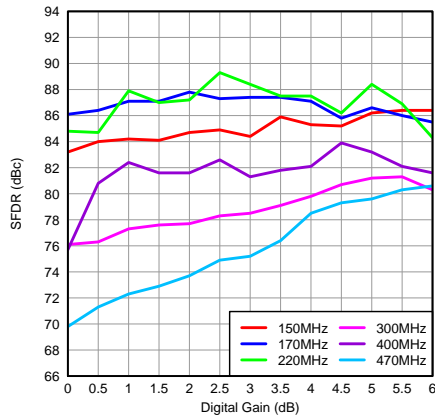

Figure 94. SFDR vs Gain and Input Frequency

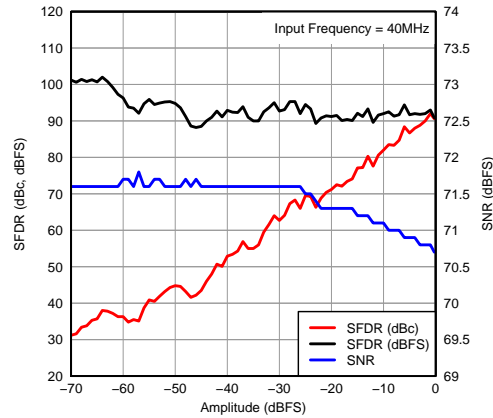

Figure 95. Performance vs Input Amplitude

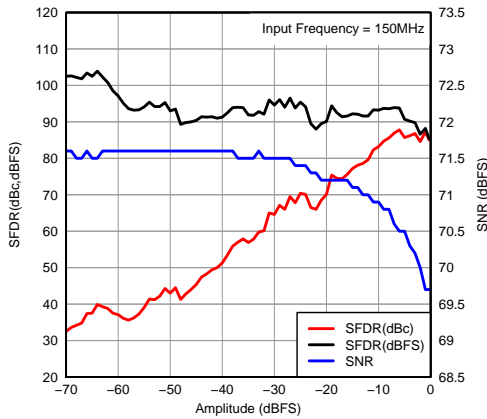

Figure 96. Performance vs Input Amplitude

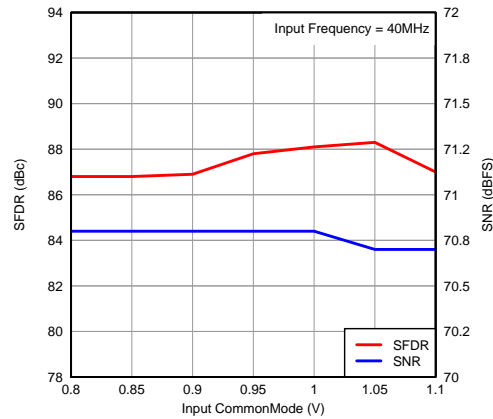

Figure 97. Performance vs Input Common-Mode Voltage

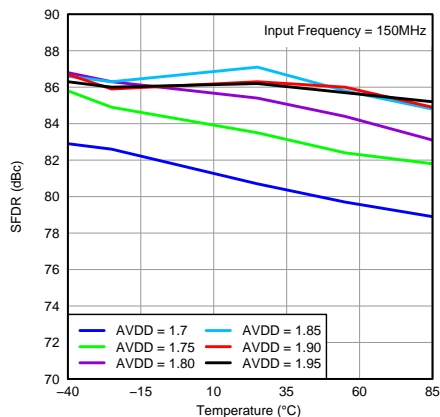

Figure 98. SFDR vs Temperature and AVDD Supply

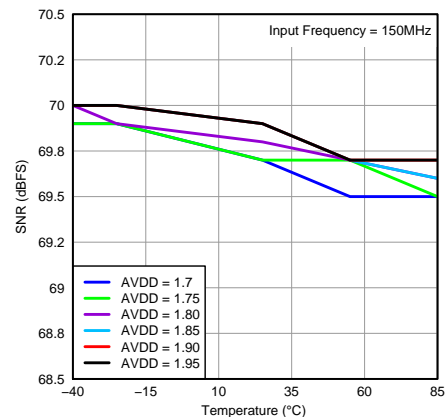
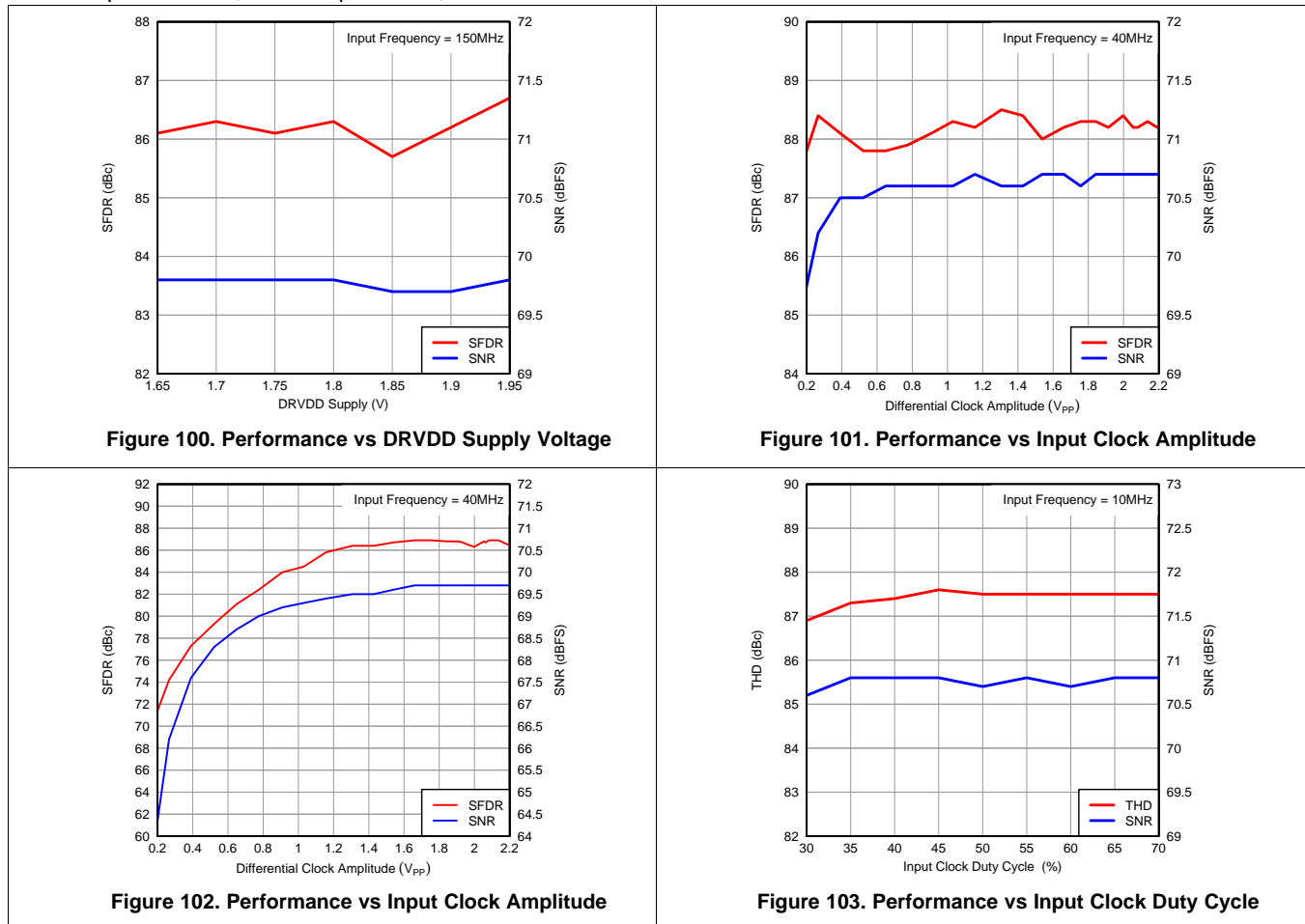

Figure 99. SNR vs Temperature and AVDD Supply

ADS4225 (continued)

At $T_A = 25^\circ\text{C}$, $AVDD = 1.8\text{ V}$, $DRVDD = 1.8\text{ V}$, maximum rated sampling frequency, sine wave input clock, $1.5\text{-}V_{PP}$ differential clock amplitude, 50% clock duty cycle, -1 dBFS differential analog input, High-Performance Mode disabled, 0-dB gain, DDR LVDS output interface, and 32k point FFT, unless otherwise noted.



8.12.6 ADS4222

At $T_A = 25^\circ\text{C}$, $AVDD = 1.8\text{ V}$, $DRVDD = 1.8\text{ V}$, maximum rated sampling frequency, sine wave input clock, $1.5\text{-}V_{PP}$ differential clock amplitude, 50% clock duty cycle, -1 dBFS differential analog input, High-Performance Mode disabled, 0-dB gain, DDR LVDS output interface, and 32k point FFT, unless otherwise noted.

ADS4222 (continued)

At $T_A = 25^\circ\text{C}$, $AVDD = 1.8\text{ V}$, $DRVDD = 1.8\text{ V}$, maximum rated sampling frequency, sine wave input clock, 1.5-V_{PP} differential clock amplitude, 50% clock duty cycle, -1 dBFS differential analog input, High-Performance Mode disabled, 0-dB gain, DDR LVDS output interface, and 32k point FFT, unless otherwise noted.

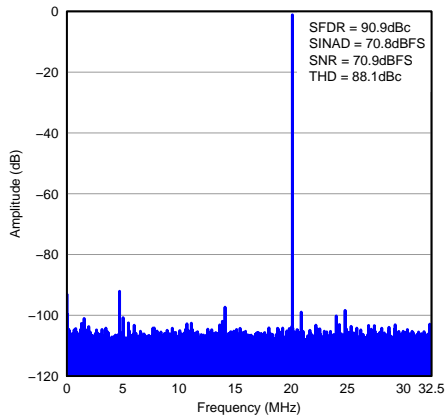

Figure 104. FFT for 20-MHz Input Signal

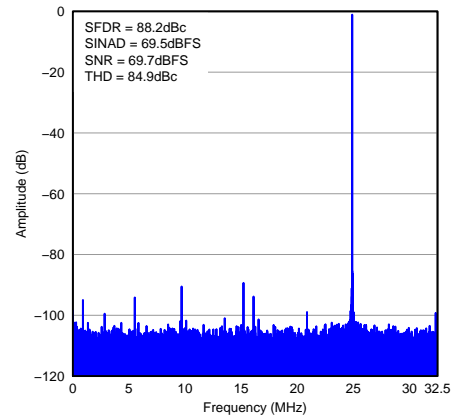

Figure 105. FFT for 170-MHz Input Signal

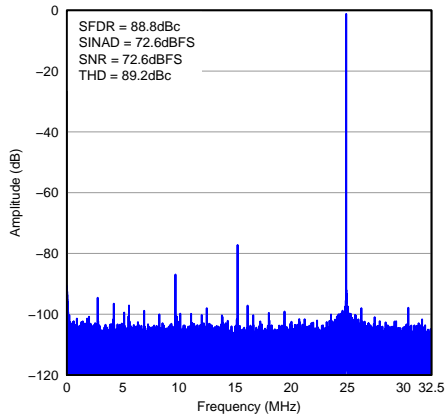

Figure 106. FFT for 300-MHz Input Signal

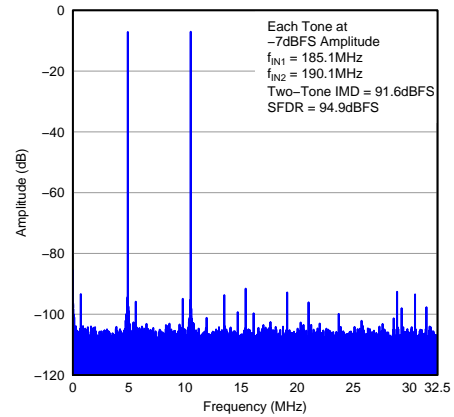

Figure 107. FFT for Two-Tone Input Signal

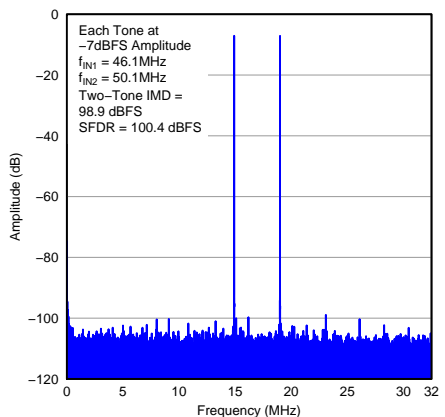

Figure 108. FFT for Two-Tone Input Signal

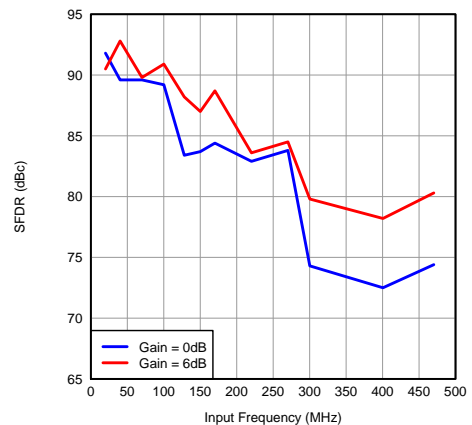

Figure 109. SFDR vs Input Frequency

ADS4222 (continued)

At $T_A = 25^\circ\text{C}$, $AVDD = 1.8\text{ V}$, $DRVDD = 1.8\text{ V}$, maximum rated sampling frequency, sine wave input clock, $1.5\text{-}V_{PP}$ differential clock amplitude, 50% clock duty cycle, -1 dBFS differential analog input, High-Performance Mode disabled, 0-dB gain, DDR LVDS output interface, and 32k point FFT, unless otherwise noted.

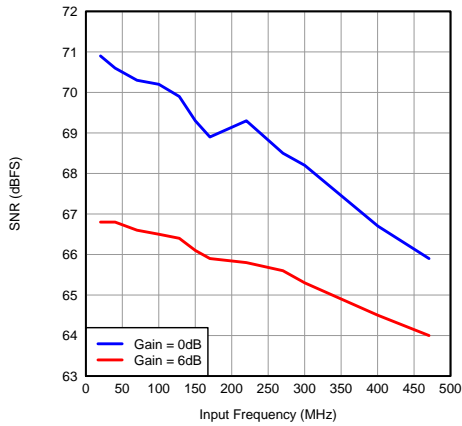

Figure 110. SNR vs Input Frequency

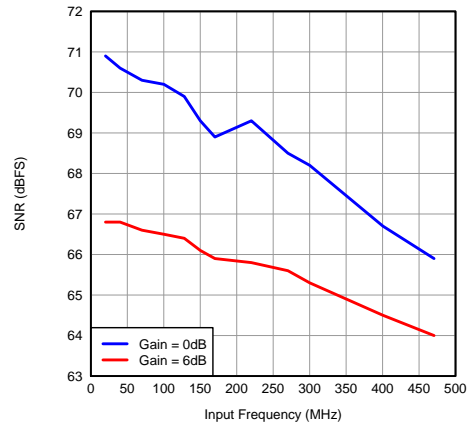

Figure 111. SNR vs Input Frequency (CMOS)

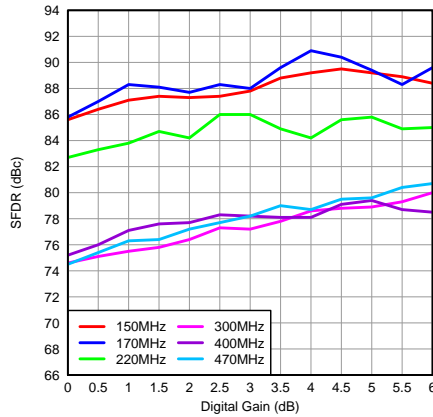

Figure 112. SFDR vs Gain and Input Frequency

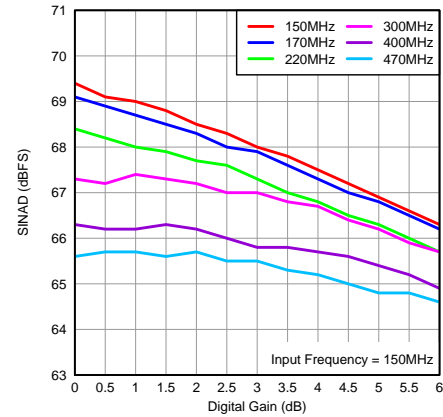

Figure 113. SINAD vs Gain and Input Frequency

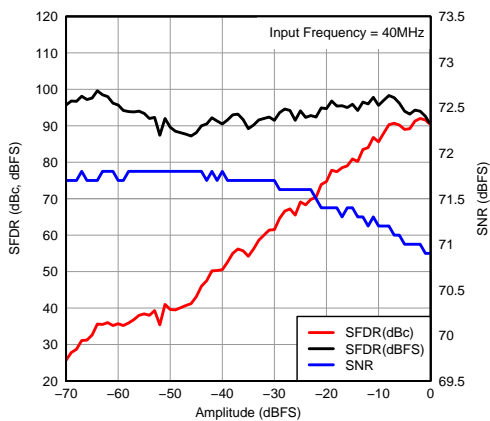

Figure 114. Performance vs Input Amplitude

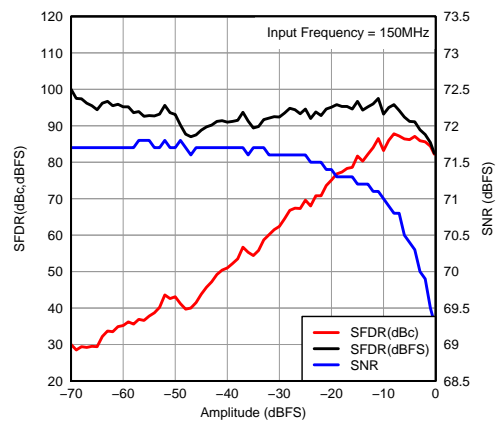

Figure 115. Performance vs Input Amplitude

ADS4222 (continued)

At $T_A = 25^\circ\text{C}$, $AVDD = 1.8\text{ V}$, $DRVDD = 1.8\text{ V}$, maximum rated sampling frequency, sine wave input clock, 1.5-V_{PP} differential clock amplitude, 50% clock duty cycle, -1 dBFS differential analog input, High-Performance Mode disabled, 0-dB gain, DDR LVDS output interface, and 32k point FFT, unless otherwise noted.

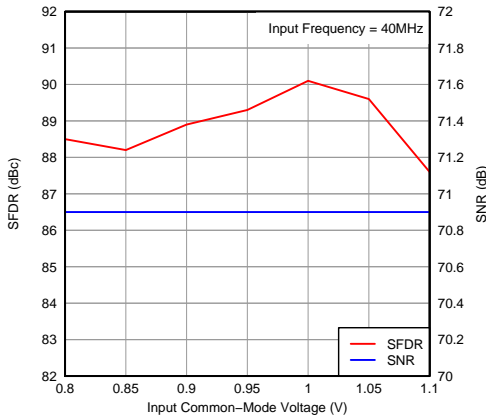

Figure 116. Performance vs Input Common-Mode Voltage

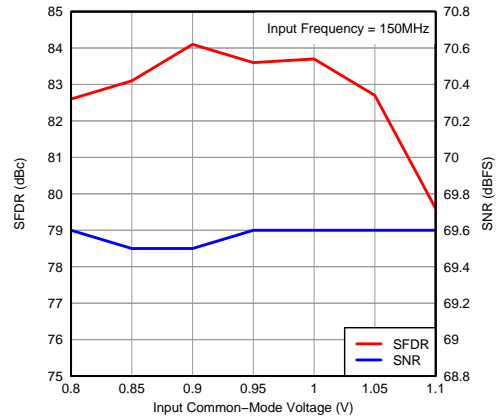

Figure 117. Performance vs Input Common-Mode Voltage

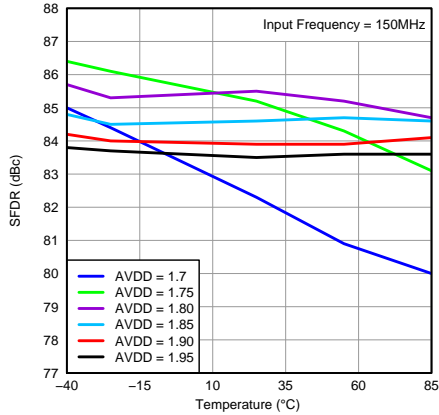

Figure 118. SFDR vs Temperature and AVDD Supply

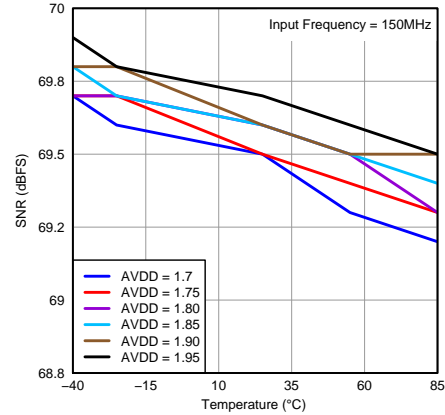

Figure 119. SNR vs Temperature and AVDD Supply

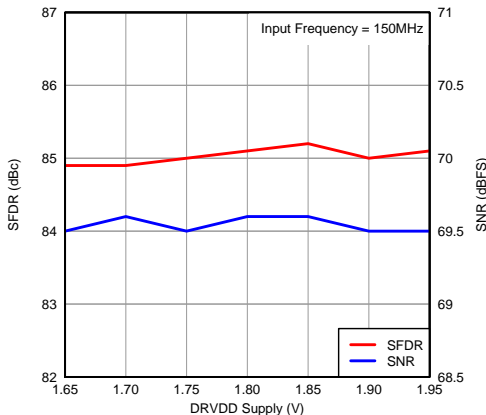

Figure 120. Performance vs DRVDD Supply Voltage

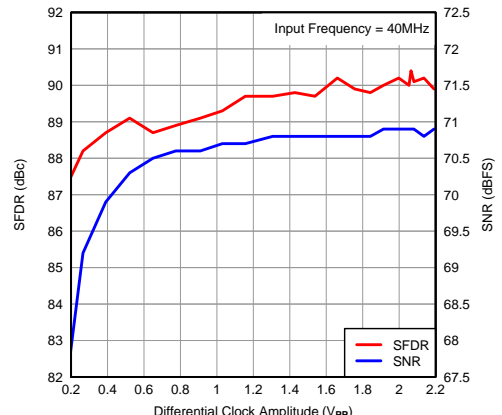
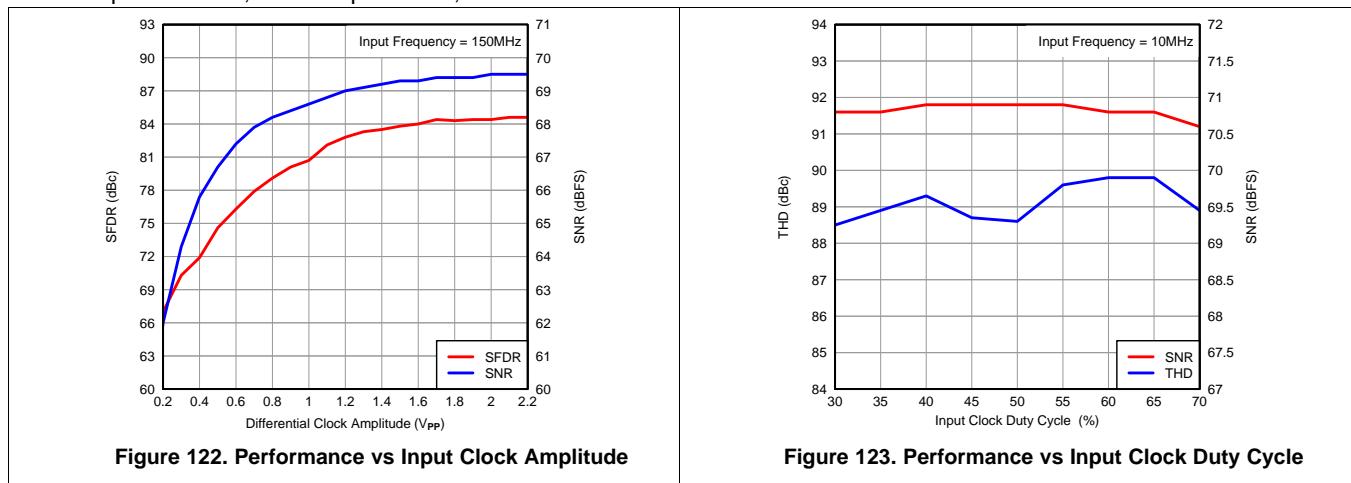

Figure 121. Performance vs Input Clock Amplitude

ADS4222 (continued)

At $T_A = 25^\circ\text{C}$, $AVDD = 1.8\text{ V}$, $DRVDD = 1.8\text{ V}$, maximum rated sampling frequency, sine wave input clock, $1.5\text{-}V_{PP}$ differential clock amplitude, 50% clock duty cycle, -1 dBFS differential analog input, High-Performance Mode disabled, 0-dB gain, DDR LVDS output interface, and 32k point FFT, unless otherwise noted.



8.12.7 General

At $T_A = 25^\circ\text{C}$, $AVDD = 1.8\text{ V}$, $DRVDD = 1.8\text{ V}$, maximum rated sampling frequency, sine wave input clock, $1.5\text{-}V_{PP}$ differential clock amplitude, 50% clock duty cycle, -1 dBFS differential analog input, High-Performance Mode disabled, 0-dB gain, DDR LVDS output interface, and 32k point FFT, unless otherwise noted.

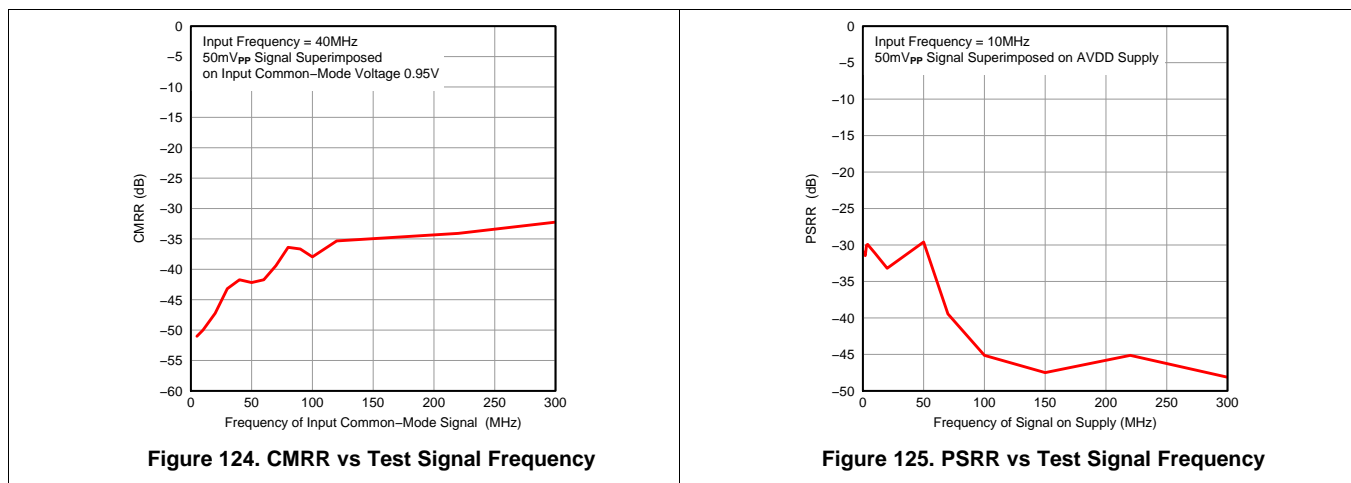

General (continued)

At $T_A = 25^\circ\text{C}$, $AVDD = 1.8\text{ V}$, $DRVDD = 1.8\text{ V}$, maximum rated sampling frequency, sine wave input clock, $1.5\text{-}V_{PP}$ differential clock amplitude, 50% clock duty cycle, -1 dBFS differential analog input, High-Performance Mode disabled, 0-dB gain, DDR LVDS output interface, and 32k point FFT, unless otherwise noted.

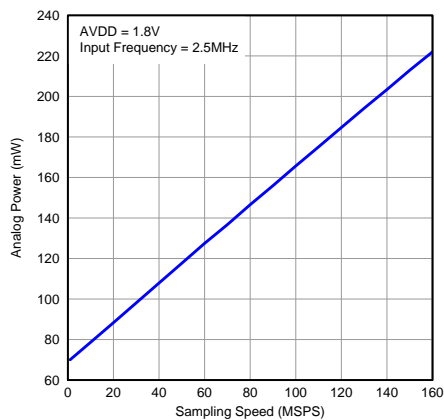

Figure 126. Analog Power vs Sampling Frequency

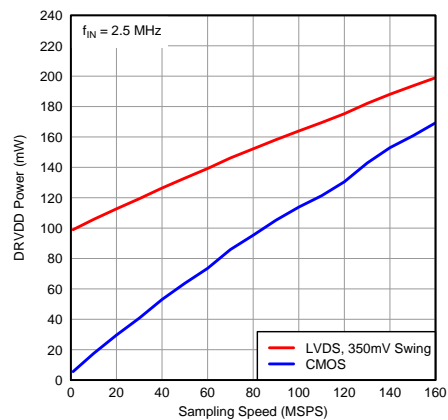

Figure 127. Digital Power LVDS CMOS

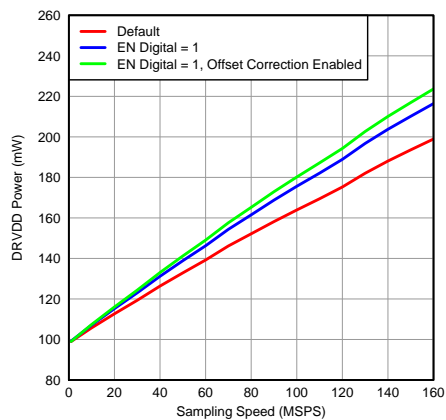

Figure 128. Digital Power in Various Modes (LVDS)

At $T_A = 25^\circ\text{C}$, $AVDD = 1.8\text{ V}$, $DRVDD = 1.8\text{ V}$, maximum rated sampling frequency, sine wave input clock, 1.5- V_{PP} differential clock amplitude, 50% clock duty cycle, -1 dBFS differential analog input, High-Performance Mode disabled, 0-dB gain, DDR LVDS output interface, and 32k point FFT, unless otherwise noted.

8.12.8 Contour

All graphs are at 25°C , $AVDD = 1.8\text{ V}$, $DRVDD = 1.8\text{ V}$, maximum rated sampling frequency, sine wave input clock. 1.5- V_{PP} differential clock amplitude, 50% clock duty cycle, -1 dBFS differential analog input, High-Performance Mode disabled, 0-dB gain, DDR LVDS output interface, and 32k point FFT, unless otherwise noted.

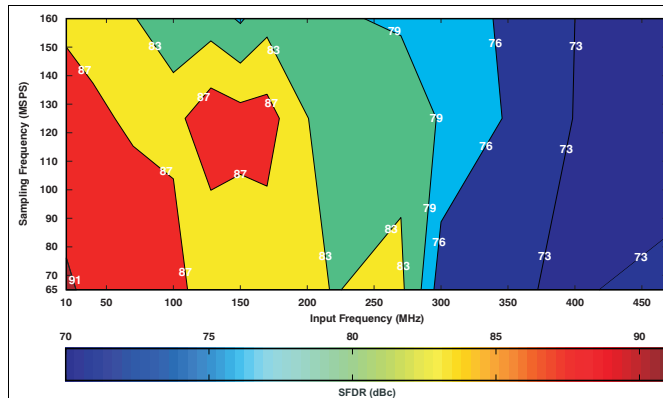

Figure 129. Spurious-Free Dynamic Range (0-dB Gain)

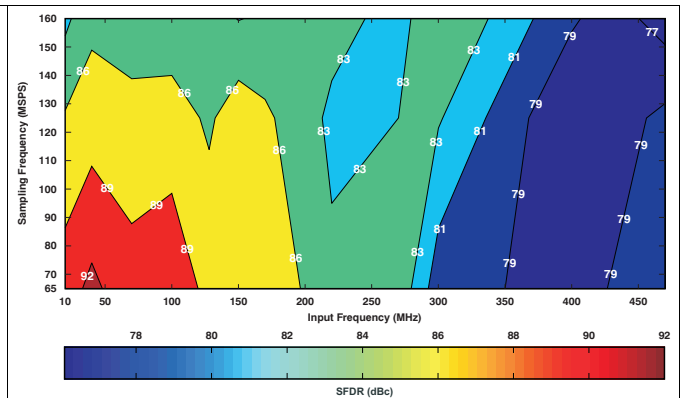

Figure 130. Spurious-Free Dynamic Range (6-dB Gain)

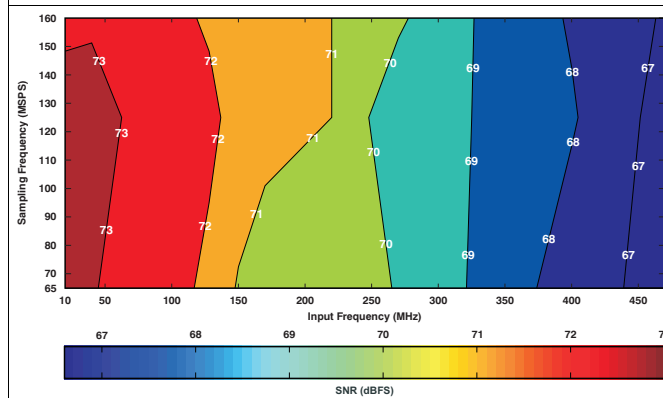

Figure 131. ADS424x Signal-to-Noise Ratio (0-dB Gain)

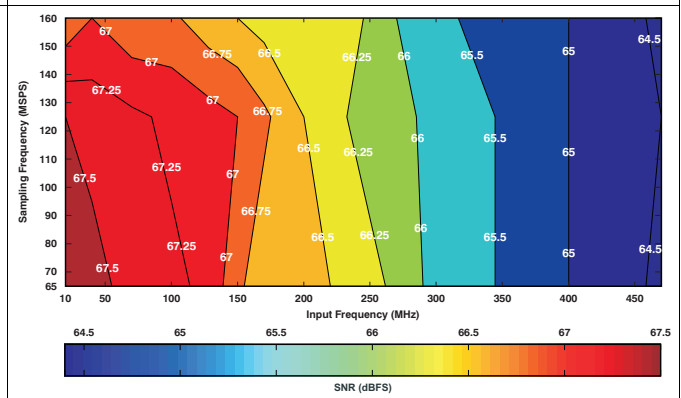

Figure 132. ADS424x Signal-to-Noise Ratio (6-dB Gain)

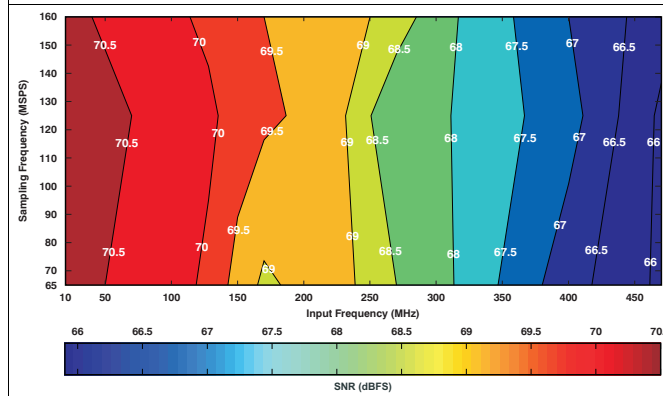

Figure 133. ADS422x Signal-to-Noise Ratio (0-dB Gain)

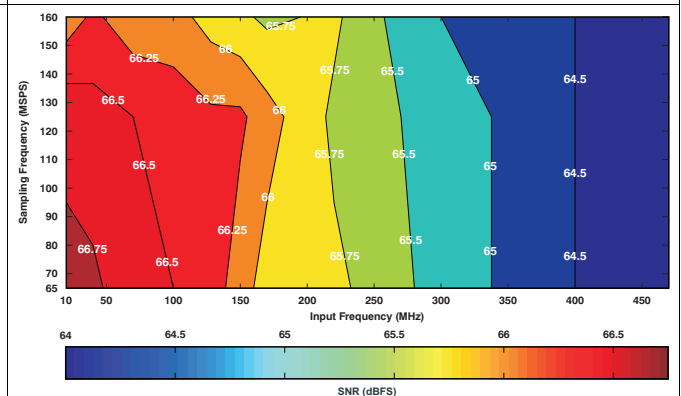

Figure 134. ADS422x Signal-to-Noise Ratio (6-dB Gain)

9 Detailed Description

9.1 Overview

The ADS424x/422x belong to TI's ultralow power family of dual-channel, 14-bit/12-bit, analog-to-digital converters (ADCs). High performance is maintained, while power is reduced for power-sensitive applications. In addition to its low power and high performance, the ADS424x/422x has a number of digital features and operating modes to enable design flexibility.

9.2 Functional Block Diagrams

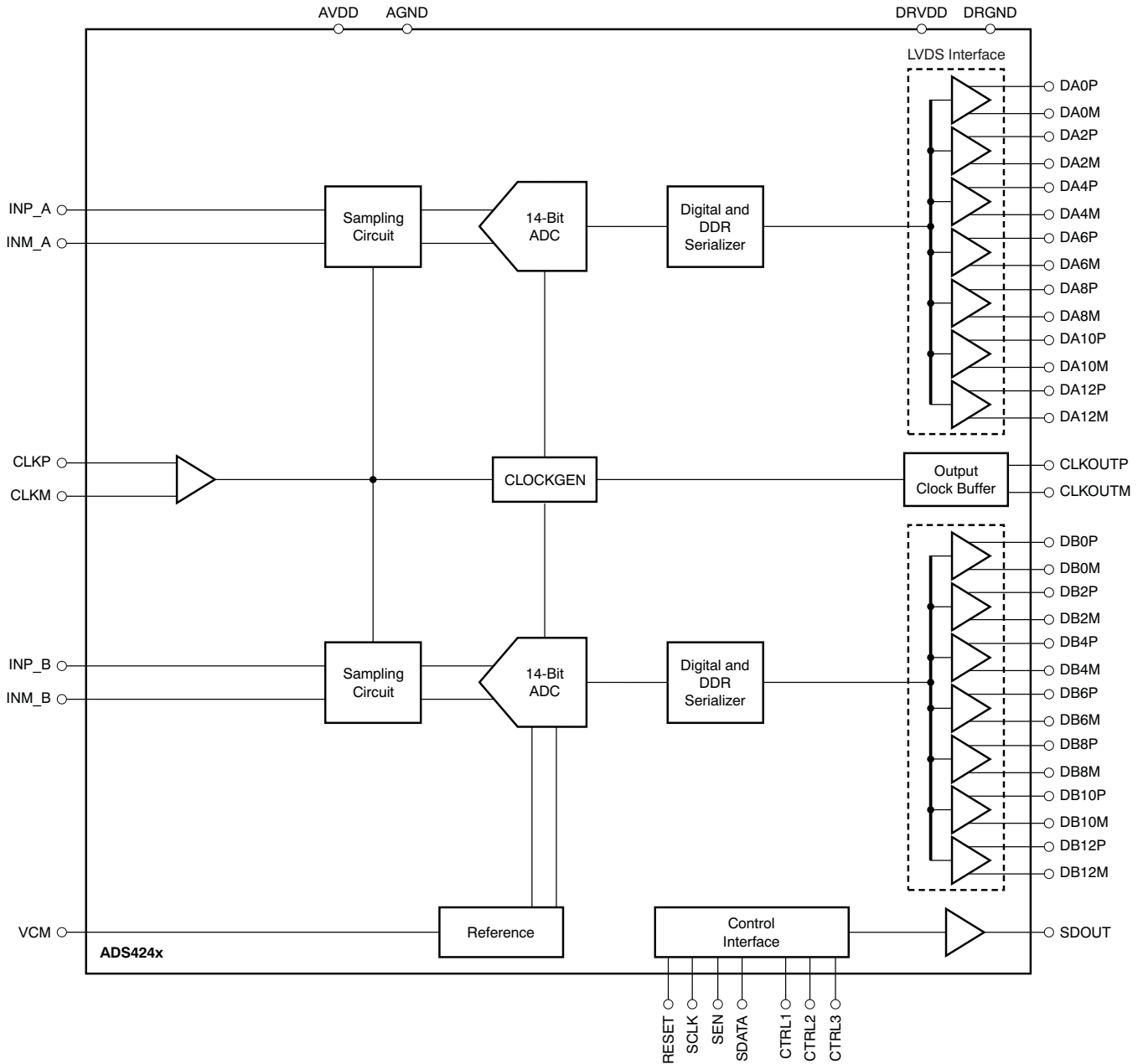

Figure 135. ADS4246/45/42 Block Diagram

Functional Block Diagrams (continued)

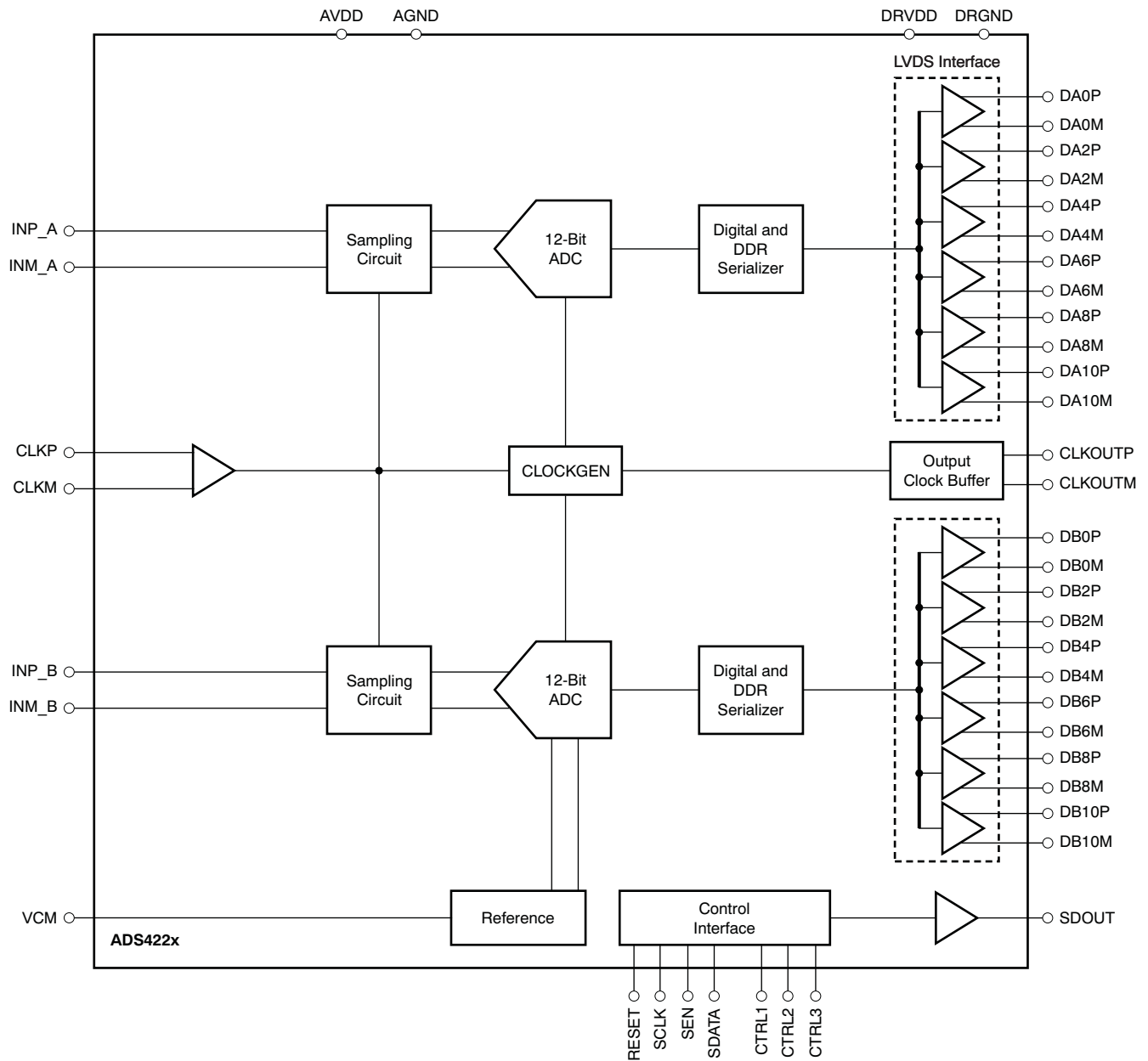

Figure 136. ADS4226/25/22 Block Diagram

9.3 Feature Description

The ADS424x/422x are pin-compatible with the previous generation ADS62P49 family of data converters; this architecture enables easy migration. However, there are some important differences between the two device generations, summarized in Table 4.

Table 4. Migrating from the ADS62P49

ADS62P49 FAMILY	ADS424x/422x FAMILY
PINS	
Pin 22 is NC (not connected)	Pin 22 is AVDD
Pins 38 and 58 are DRVDD	Pins 38 and 58 are NC (do not connect, must be floated)
Pins 39 and 59 are DRGND	Pins 39 and 59 are NC (do not connect, must be floated)
SUPPLY	
AVDD is 3.3 V	AVDD is 1.8 V
DRVDD is 1.8 V	No change
INPUT COMMON-MODE VOLTAGE	
VCM is 1.5 V	VCM is 0.95 V
SERIAL INTERFACE	
Protocol: 8-bit register address and 8-bit register data	No change in protocol New serial register map
EXTERNAL REFERENCE	
Supported	Not supported

9.3.1 Analog Input

The analog input consists of a switched-capacitor based, differential sample-and-hold (S/H) architecture. This differential topology results in very good ac performance even for high input frequencies at high sampling rates. The INP and INM pins must be externally biased around a common-mode voltage of 0.95 V, available on the VCM pin. For a full-scale differential input, each input pin (INP and INM) must swing symmetrically between $V_{CM} + 0.5\text{ V}$ and $V_{CM} - 0.5\text{ V}$, resulting in a $2\text{-}V_{PP}$ differential input swing. The input sampling circuit has a high 3 dB bandwidth that extends up to 550 MHz (measured from the input pins to the sampled voltage). Figure 137 shows an equivalent circuit for the analog input.

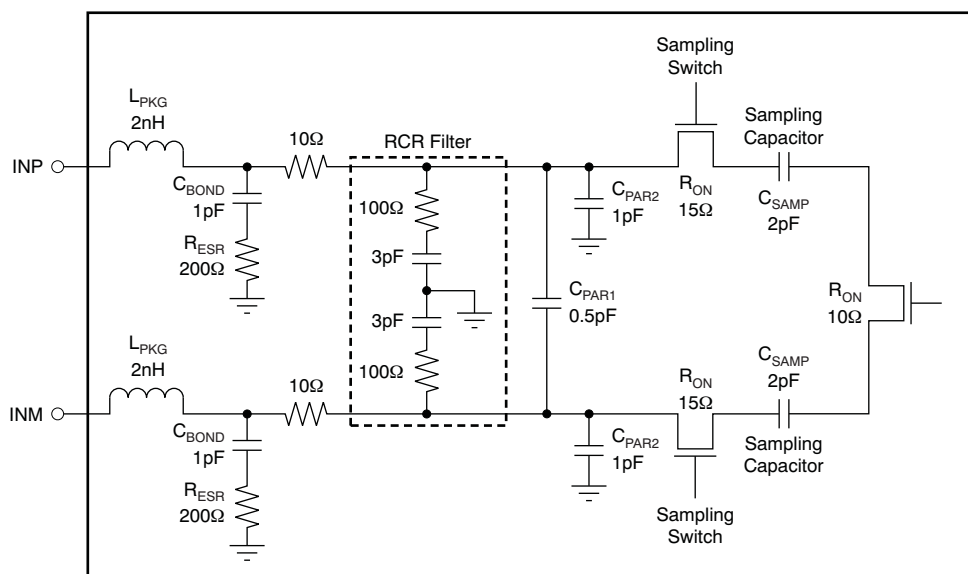

Figure 137. Analog Input Equivalent Circuit

9.3.1.1 Drive Circuit Requirements

For optimum performance, the analog inputs must be driven differentially. This operation improves the common-mode noise immunity and even-order harmonic rejection. A 5Ω to 15Ω resistor in series with each input pin is recommended to damp out ringing caused by package parasitics.

SFDR performance can be limited as a result of several reasons, including the effects of sampling glitches, nonlinearity of the sampling circuit, and nonlinearity of the quantizer that follows the sampling circuit. Depending on the input frequency, sample rate, and input amplitude, one of these factors plays a dominant part in limiting performance. At very high input frequencies (greater than approximately 300 MHz), SFDR is determined largely by the device sampling circuit nonlinearity. At low input amplitudes, the quantizer nonlinearity usually limits performance.

Glitches are caused by the opening and closing of the sampling switches. The driving circuit should present a low source impedance to absorb these glitches. Otherwise, glitches could limit performance, primarily at low input frequencies (up to approximately 200 MHz). It is also necessary to present low impedance (less than 50Ω) for the common-mode switching currents. This configuration can be achieved by using two resistors from each input terminated to the common-mode voltage (VCM).

The device includes an internal R-C filter from each input to ground. The purpose of this filter is to absorb the sampling glitches inside the device itself. The cutoff frequency of the R-C filter involves a trade-off. A lower cutoff frequency (larger C) absorbs glitches better, but it reduces the input bandwidth. On the other hand, with a higher cutoff frequency (smaller C), bandwidth support is maximized. However, the sampling glitches now must be supplied by the external drive circuit. This tradeoff has limitations as a result of the presence of the package bond-wire inductance.

In the ADS424x/422x, the R-C component values have been optimized while supporting high input bandwidth (up to 550 MHz). However, in applications with input frequencies up to 200 MHz to 300 MHz, the filtering of the glitches can be improved further using an external R-C-R filter; see [Figure 140](#) and [Figure 141](#).

In addition, the drive circuit may have to be designed to provide a low insertion loss over the desired frequency range and matched impedance to the source. Furthermore, the ADC input impedance must be considered. [Figure 138](#) and [Figure 139](#) show the impedance ($Z_{IN} = R_{IN} \parallel C_{IN}$) looking into the ADC input pins.

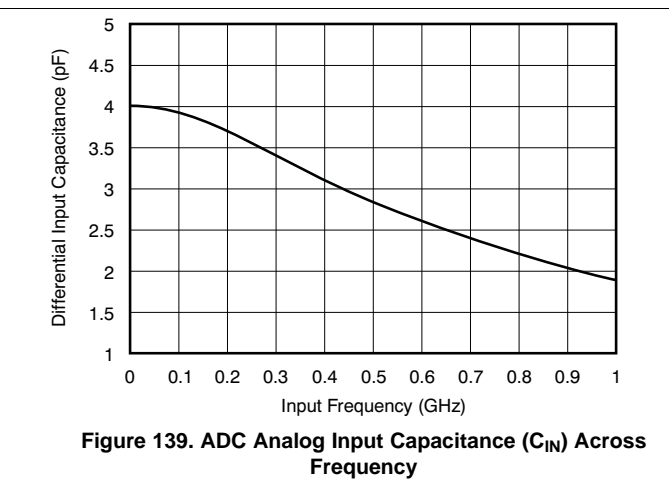
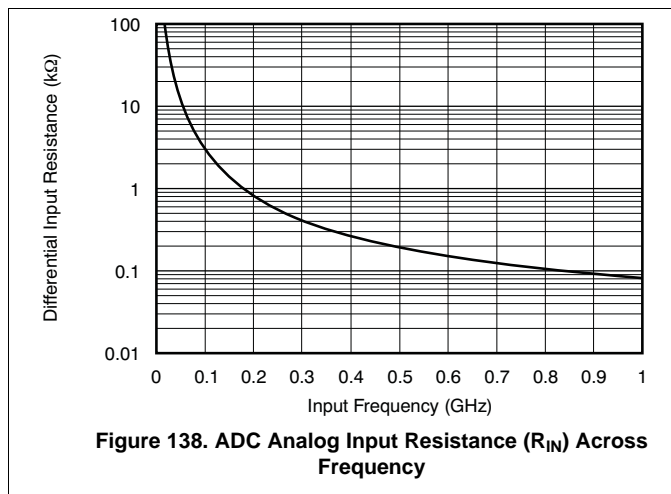

9.3.1.2 Driving Circuit

Two example driving circuit configurations are shown in [Figure 140](#) and [Figure 141](#)—one optimized for low bandwidth (low input frequencies) and the other one for high bandwidth to support higher input frequencies. Note that both of the drive circuits have been terminated by 50Ω near the ADC side. The termination is accomplished by a 25-Ω resistor from each input to the 1.5-V common-mode (VCM) from the device. This architecture allows the analog inputs to be biased around the required common-mode voltage.

The mismatch in the transformer parasitic capacitance (between the windings) results in degraded even-order harmonic performance. Connecting two identical RF transformers back-to-back helps minimize this mismatch; good performance is obtained for high-frequency input signals. An additional termination resistor pair may be required between the two transformers, as shown in [Figure 140](#), [Figure 141](#), and [Figure 142](#). The center point of this termination is connected to ground to improve the balance between the P and M sides. The values of the terminations between the transformers and on the secondary side must be chosen to obtain an effective 50 Ω (in the case of 50-Ω source impedance).

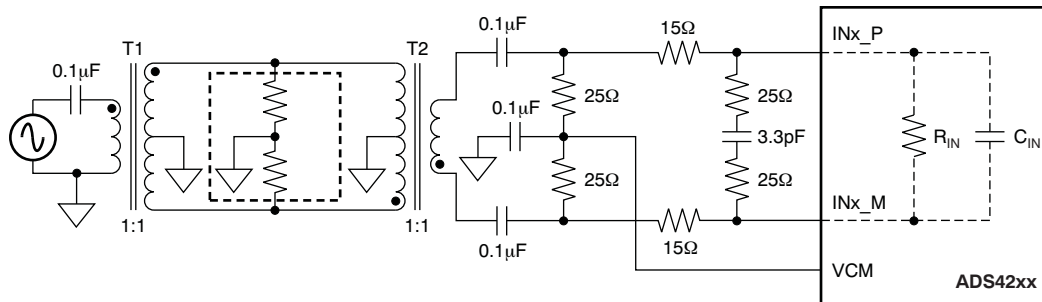

Figure 140. Drive Circuit with Low Bandwidth (for Low Input Frequencies Less Than 150 MHz)

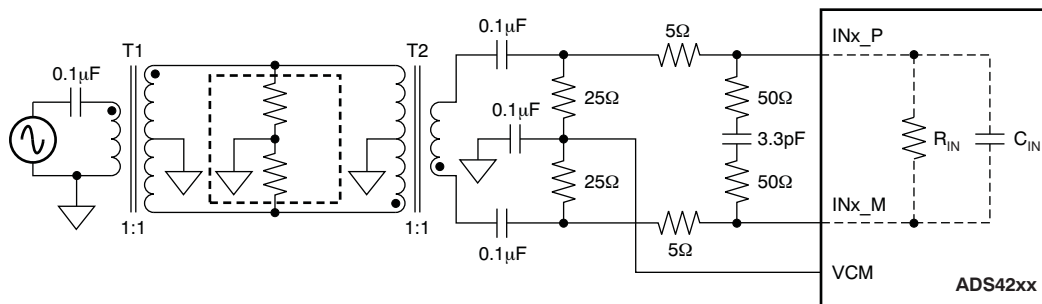

Figure 141. Drive Circuit with High Bandwidth (for High Input Frequencies Greater Than 150 MHz and Less Than 270 MHz)

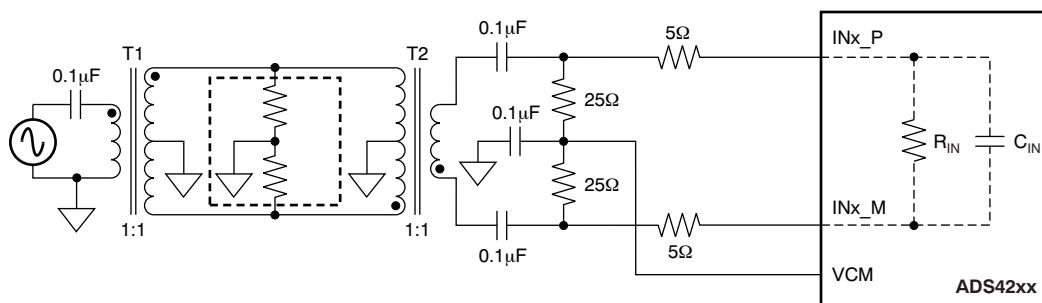

Figure 142. Drive Circuit with Very High Bandwidth (Greater than 270 MHz)

All of these examples show 1:1 transformers being used with a 50-Ω source. As explained in the [Drive Circuit Requirements](#) section, this configuration helps to present a low source impedance to absorb the sampling glitches. With a 1:4 transformer, the source impedance is 200 Ω. The higher source impedance is unable to absorb the sampling glitches effectively and can lead to degradation in performance (compared to using 1:1 transformers).

In almost all cases, either a band-pass or low-pass filter is required to obtain the desired dynamic performance, as shown in [Figure 143](#). Such filters present low source impedance at the high frequencies corresponding to the sampling glitch and help avoid the performance loss with the high source impedance.

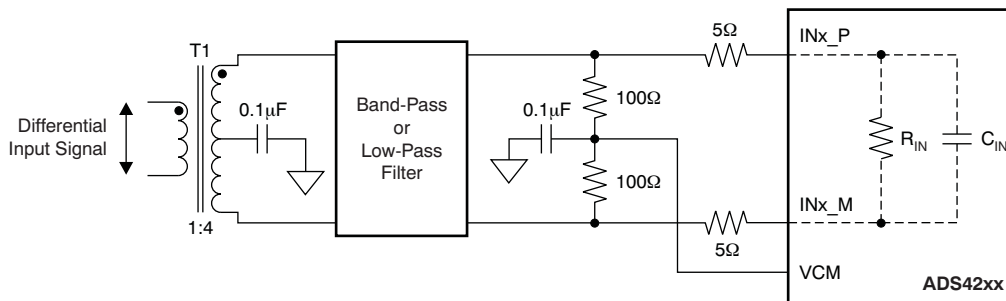

Figure 143. Drive Circuit with a 1:4 Transformer

9.3.2 Clock Input

The ADS424x/422x clock inputs can be driven differentially (sine, LVPECL, or LVDS) or single-ended (LVCMOS), with little or no difference in performance between them. The common-mode voltage of the clock inputs is set to VCM using internal 5-kΩ resistors. This setting allows the use of transformer-coupled drive circuits for sine-wave clock or ac-coupling for LVPECL and LVDS clock sources are shown in [Figure 144](#), [Figure 145](#) and [Figure 146](#). The internal clock buffer is shown in [Figure 147](#).

R_T = termination resistor, if necessary.

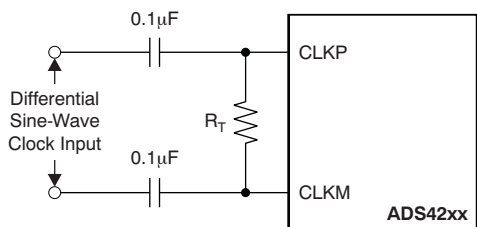

Figure 144. Differential Sine-Wave Clock Driving Circuit

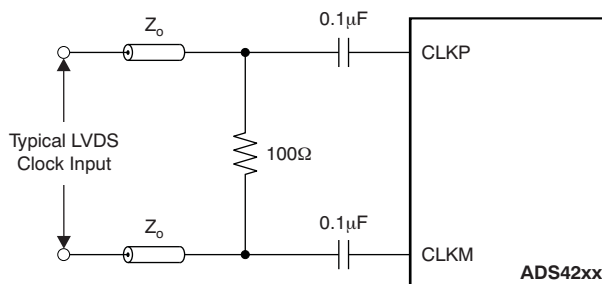

Figure 145. LVDS Clock Driving Circuit

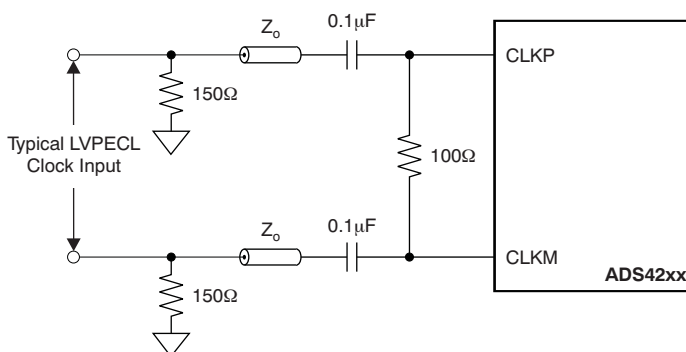
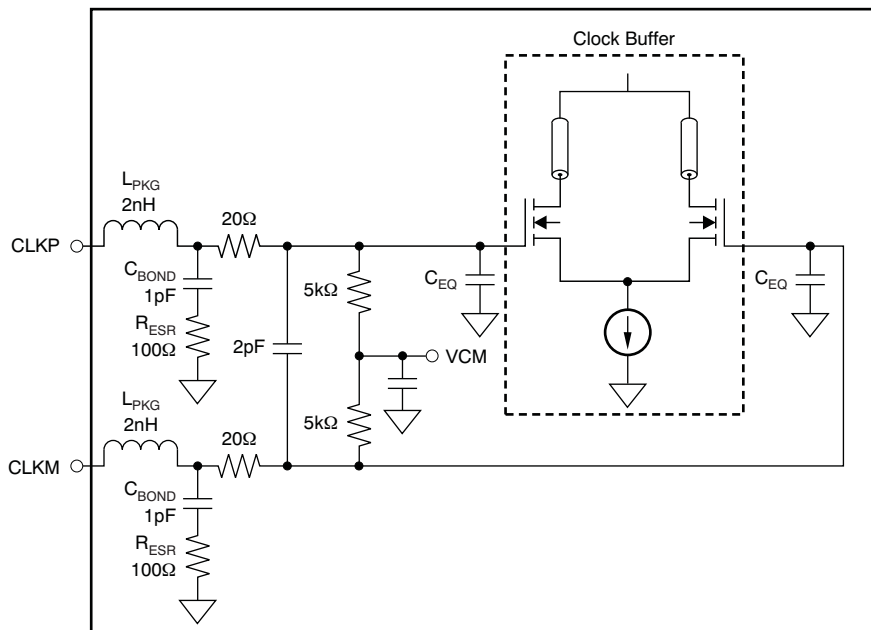

Figure 146. LVPECL Clock Driving Circuit



C_{EQ} is 1 pF to 3 pF, and is the equivalent input capacitance of the clock buffer.

Figure 147. Internal Clock Buffer

A single-ended CMOS clock can be ac-coupled to the CLKP input, with CLKM connected to ground with a 0.1- μ F capacitor, as shown in Figure 148. For best performance, the clock inputs must be driven differentially, thereby reducing susceptibility to common-mode noise. For high input frequency sampling, it is recommended to use a clock source with very low jitter. Band-pass filtering of the clock source can help reduce the effects of jitter. There is no change in performance with a non-50% duty cycle clock input.

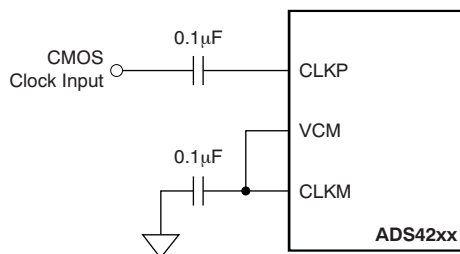

Figure 148. Single-Ended Clock Driving Circuit

9.3.3 Digital Functions

The device has several useful digital functions (such as test patterns, gain, and offset correction). These functions require extra clock cycles for operation and increase the overall latency and power of the device. These digital functions are disabled by default after reset and the raw ADC output is routed to the output data pins with a latency of 16 clock cycles. Figure 149 shows more details of the processing after the ADC. In order to use any of the digital functions, the EN DIGITAL bit must be set to 1. After this, the respective register bits must be programmed as described in the following sections and in the Register Maps section.

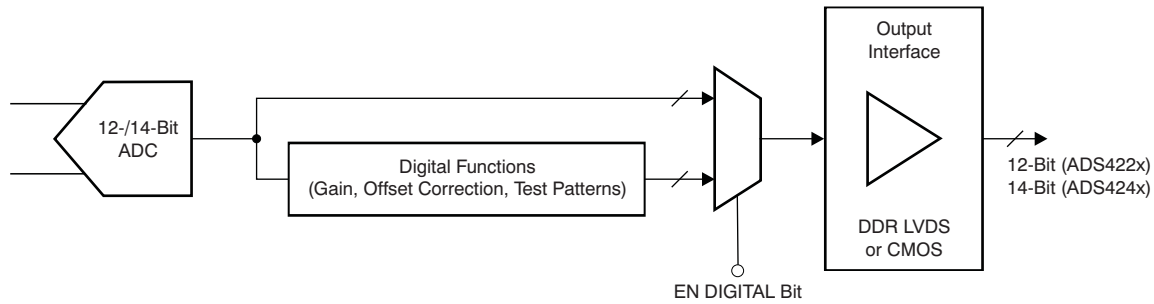

Figure 149. Digital Processing Block

9.3.4 Gain for SFDR/SNR Trade-off

The ADS424x/422x include gain settings that can be used to get improved SFDR performance (compared to no gain). The gain is programmable from 0 dB to 6 dB (in 0.5-dB steps). For each gain setting, the analog input full-scale range scales proportionally, as shown in Table 5.

The SFDR improvement is achieved at the expense of SNR; for each gain setting, the SNR degrades approximately between 0.5 dB and 1 dB. The SNR degradation is reduced at high input frequencies. As a result, the gain is very useful at high input frequencies because the SFDR improvement is significant with marginal degradation in SNR. Therefore, the gain can be used as a trade-off between SFDR and SNR. Note that the default gain after reset is 0 dB.

Table 5. Full-Scale Range Across Gains

GAIN (dB)	TYPE	FULL-SCALE (V _{PP})
0	Default after reset	2
1	Fine, programmable	1.78
2	Fine, programmable	1.59
3	Fine, programmable	1.42
4	Fine, programmable	1.26
5	Fine, programmable	1.12
6	Fine, programmable	1

9.3.5 Offset Correction

The ADS424x/422x have an internal offset correction algorithm that estimates and corrects dc offset up to ± 10 mV. The correction can be enabled using the ENABLE OFFSET CORR serial register bit. Once enabled, the algorithm estimates the channel offset and applies the correction every clock cycle. The time constant of the correction loop is a function of the sampling clock frequency. The time constant can be controlled using the OFFSET CORR TIME CONSTANT register bits, as described in [Table 6](#).

After the offset is estimated, the correction can be frozen by setting FREEZE OFFSET CORR = 0. Once frozen, the last estimated value is used for the offset correction of every clock cycle. Note that offset correction is disabled by default after reset.

Table 6. Time Constant of Offset Correction Algorithm

OFFSET CORR TIME CONSTANT	TIME CONSTANT, $T_{C_{CLK}}$ (Number of Clock Cycles)	TIME CONSTANT, $T_{C_{CLK}} \times 1/f_s$ (ms) ⁽¹⁾
0000	1M	7
0001	2M	13
0010	4M	26
0011	8M	52
0100	16M	105
0101	32M	210
0110	64M	419
0111	128M	839
1000	256M	1678
1001	512M	3355
1010	1G	6711
1011	2G	13422
1100	Reserved	—
1101	Reserved	—
1110	Reserved	—
1111	Reserved	—

(1) Sampling frequency, $f_s = 160$ MSPS.

9.4 Device Functional Modes

9.4.1 Power-Down

The ADS424x/422x have two power-down modes: global power-down and channel standby. These modes can be set using either the serial register bits or using the control pins CTRL1 to CTRL3 (as shown in [Table 7](#)).

Table 7. Power-Down Settings

CTRL1	CTRL2	CTRL3	DESCRIPTION
Low	Low	Low	Default
Low	Low	High	Not available
Low	High	Low	Not available
Low	High	High	Not available
High	Low	Low	Global power-down
High	Low	High	Channel A powered down, channel B is active
High	High	Low	Not available
High	High	High	MUX mode of operation, channel A and B data is multiplexed and output on DB[10:0] pins

9.4.1.1 Global Power-Down

In this mode, the entire chip (including ADCs, internal reference, and output buffers) are powered down, resulting in reduced total power dissipation of approximately 20 mW when the CTRL pins are used, and 3 mW when the PDN GLOBAL serial register bit is used. The output buffers are in high-impedance state. The wake-up time from global power-down to data becoming valid in normal mode is typically 100µs.

9.4.1.2 Channel Standby

In this mode, each ADC channel can be powered down. The internal references are active, resulting in a quick wake-up time of 50 µs. The total power dissipation in standby is approximately 200 mW at 160 MSPS.

9.4.1.3 Input Clock Stop

In addition to the previous modes, the converter enters a low-power mode when the input clock frequency falls below 1 MSPS. The power dissipation is approximately 160 mW.

9.5 Programming

The ADS424x/422x can be configured independently using either parallel interface control or serial interface programming.

9.5.1 Parallel Configuration Only

To put the device into parallel configuration mode, keep RESET tied high (AVDD). Then, use the SEN, SCLK, CTRL1, CTRL2, and CTRL3 pins to directly control certain modes of the ADC. The device can be easily configured by connecting the parallel pins to the correct voltage levels (as described in [Table 8](#) to [Table 11](#)). There is no need to apply a reset and SDATA can be connected to ground.

In this mode, SEN and SCLK function as parallel interface control pins. Some frequently-used functions can be controlled using these pins. [Table 8](#) describes the modes controlled by the parallel pins.

Table 8. Parallel Pin Definition

PIN	CONTROL MODE
SCLK	Low-speed mode selection
SEN	Output data format and output interface selection
CTRL1	Together, these pins control the power-down modes
CTRL2	
CTRL3	

9.5.2 Serial Interface Configuration Only

To enable this mode, the serial registers must first be reset to the default values and the RESET pin must be kept low. SEN, SDATA, and SCLK function as serial interface pins in this mode and can be used to access the internal registers of the ADC. The registers can be reset either by applying a pulse on the RESET pin or by setting the RESET bit high. The [Register Maps](#) section describes the register programming and the register reset process in more detail.

9.5.3 Using Both Serial Interface and Parallel Controls

For increased flexibility, a combination of serial interface registers and parallel pin controls (CTRL1 to CTRL3) can also be used to configure the device. To enable this option, keep RESET low. The parallel interface control pins CTRL1 to CTRL3 are available. After power-up, the device is automatically configured according to the voltage settings on these pins (see [Table 11](#)). SEN, SDATA, and SCLK function as serial interface digital pins and are used to access the internal registers of the ADC. The registers must first be reset to the default values either by applying a pulse on the RESET pin or by setting the RESET bit to '1'. After reset, the RESET pin must be kept low. The [Register Maps](#) section describes register programming and the register reset process in more detail.

9.5.4 Parallel Configuration Details

The functions controlled by each parallel pin are described in [Table 9](#), [Table 10](#), and [Table 11](#). A simple way of configuring the parallel pins is shown in [Figure 150](#).

Table 9. SCLK Control Pin

VOLTAGE APPLIED ON SCLK	DESCRIPTION
Low	Low-speed mode is disabled
High	Low-speed mode is enabled ⁽¹⁾

(1) Low-speed mode is enabled in the ADS4222/42 by default.

Table 10. SEN Control Pin

VOLTAGE APPLIED ON SEN	DESCRIPTION
0 (+50 mV/0 mV)	Twos complement and parallel CMOS output
(3/8) AVDD (±50 mV)	Offset binary and parallel CMOS output
(5/8) 2AVDD (±50 mV)	Offset binary and DDR LVDS output
AVDD (0 mV/–50 mV)	Twos complement and DDR LVDS output

Table 11. CTRL1, CTRL2, and CTRL3 Pins

CTRL1	CTRL2	CTRL3	DESCRIPTION
Low	Low	Low	Normal operation
Low	Low	High	Not available
Low	High	Low	Not available
Low	High	High	Not available
High	Low	Low	Global power-down
High	Low	High	Channel A standby, channel B is active
High	High	Low	Not available
High	High	High	MUX mode of operation, channel A and B data are multiplexed and output on the DB[13:0] pins.

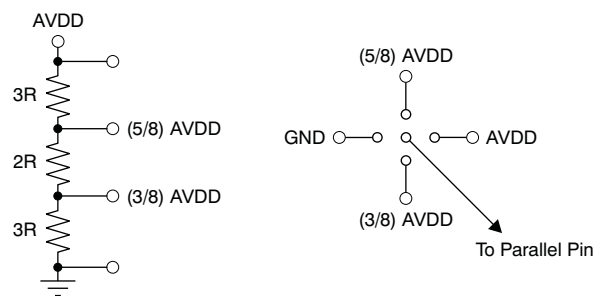

Figure 150. Simple Scheme to Configure the Parallel Pins

9.5.5 Serial Interface Details

The ADC has a set of internal registers that can be accessed by the serial interface formed by the SEN (serial interface enable), SCLK (serial interface clock), and SDATA (serial interface data) pins. Serial shift of bits into the device is enabled when SEN is low. Serial data SDATA are latched at every SCLK falling edge when SEN is active (low). The serial data are loaded into the register at every 16th SCLK falling edge when SEN is low. When the word length exceeds a multiple of 16 bits, the excess bits are ignored. Data can be loaded in multiples of 16-bit words within a single active SEN pulse. The first eight bits form the register address and the remaining eight bits are the register data. The interface can work with SCLK frequencies from 20 MHz down to very low speeds (of a few hertz) and also with non-50% SCLK duty cycle.

9.5.5.1 Register Initialization

After power-up, the internal registers must be initialized to the default values. Initialization can be accomplished in one of two ways:

1. Either through hardware reset by applying a high pulse on the RESET pin (of width greater than 10ns), as shown in Figure 151; or
2. By applying a software reset. When using the serial interface, set the RESET bit high. This setting initializes the internal registers to the default values and then self-resets the RESET bit low. In this case, the RESET pin is kept low.

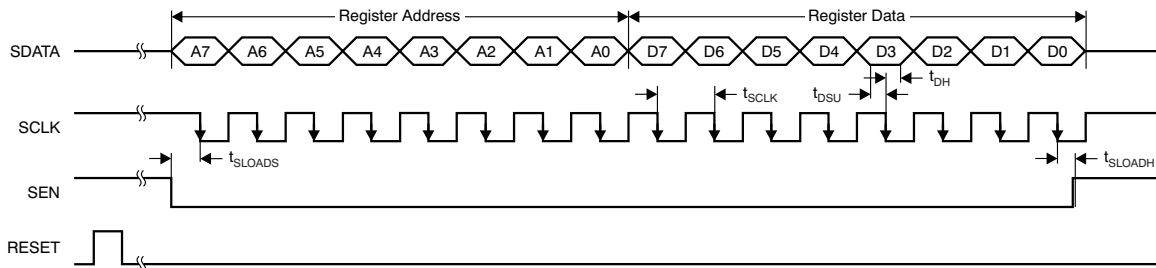

Figure 151. Serial Interface Timing

9.5.5.2 Serial Register Readout

The device includes a mode where the contents of the internal registers can be read back. This readback mode may be useful as a diagnostic check to verify the serial interface communication between the external controller and the ADC. To use readback mode, follow this procedure:

1. Set the READOUT register bit to 1. This setting disables any further writes to the registers.
2. Initiate a serial interface cycle specifying the address of the register (A7 to A0) whose content has to be read.
3. The device outputs the contents (D7 to D0) of the selected register on the SDOUT pin (pin 64).
4. The external controller can latch the contents at the SCLK falling edge.
5. To enable register writes, reset the READOUT register bit to 0.

The serial register readout works with both CMOS and LVDS interfaces on pin 64.

When READOUT is disabled, the SDOUT pin is in high-impedance state. If serial readout is not used, the SDOUT pin must float.

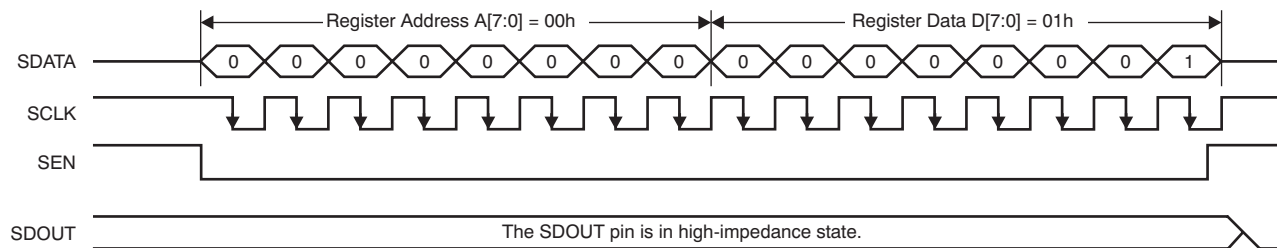

a) Enable serial readout (READOUT = 1)

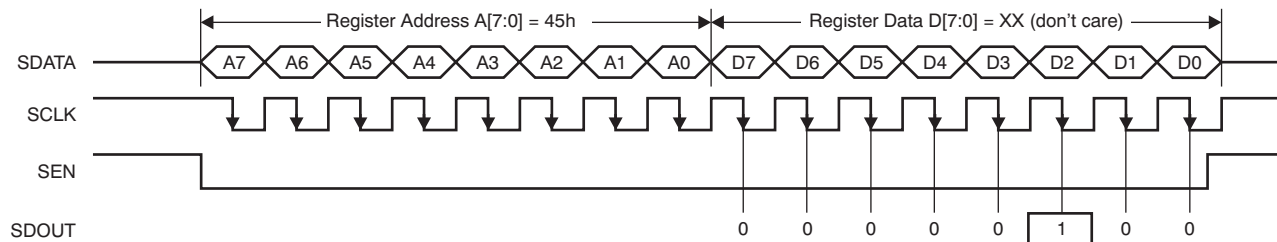

The SDO pin functions as serial readout (READOUT = 1).

b) Read contents of Register 45h. This register has been initialized with 04h (device is put into global power-down mode.)

Figure 152. Serial Readout Timing Diagram

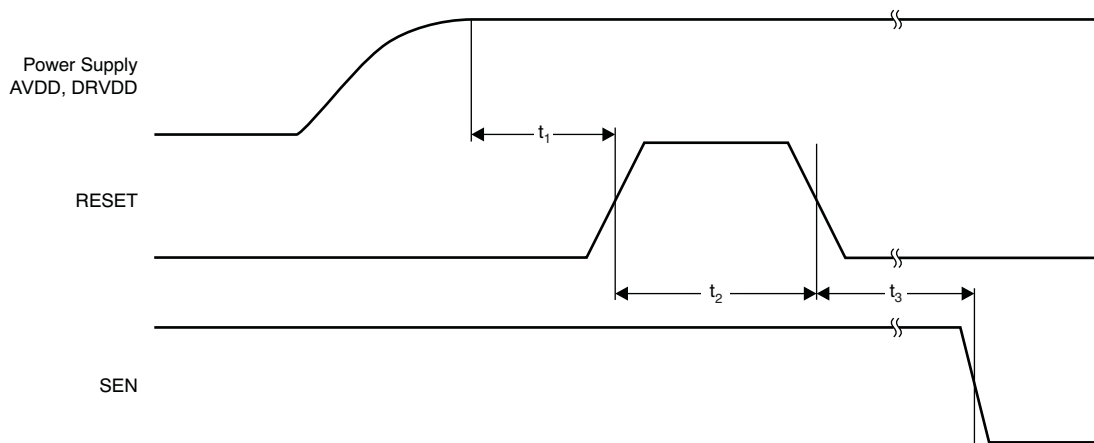

A high pulse on the RESET pin is required in the serial interface mode when initialized through a hardware reset. For parallel interface operation, RESET must be permanently tied high.

Figure 153. Reset Timing Diagram

9.5.6 Digital Output Information

The ADS424x/422x provide 14-bit/12-bit digital data for each channel and an output clock synchronized with the data.

9.5.6.1 Output Interface

Two output interface options are available: double data rate (DDR) LVDS and parallel CMOS. They can be selected using the serial interface register bit or by setting the proper voltage on the SEN pin in parallel configuration mode.

9.5.6.2 DDR LVDS Outputs

In this mode, the data bits and clock are output using low-voltage differential signal (LVDS) levels. Two data bits are multiplexed and output on each LVDS differential pair, as shown in [Figure 154](#).

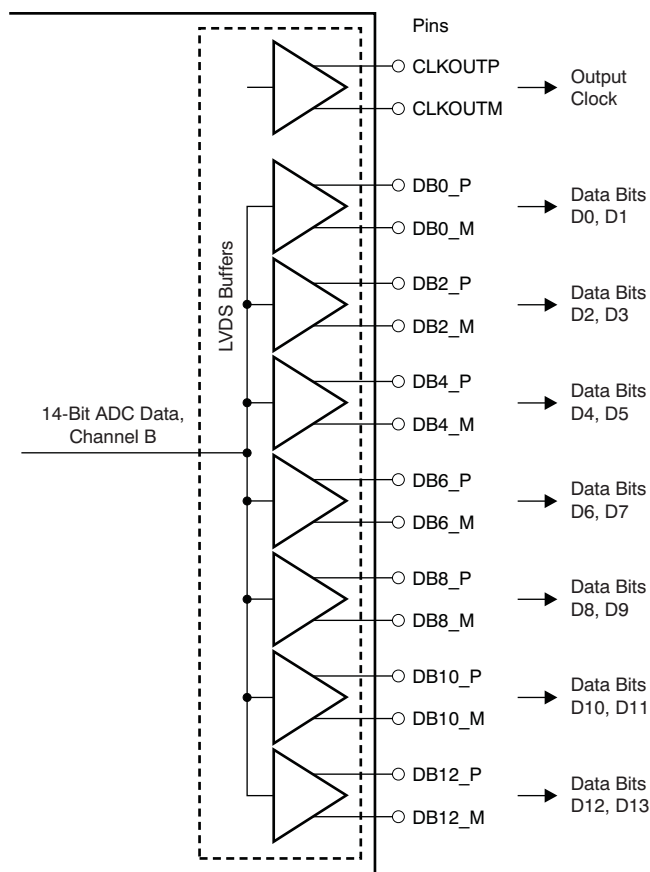

Figure 154. LVDS Interface

Even data bits (D0, D2, D4, etc.) are output at the CLKOUTP rising edge and the odd data bits (D1, D3, D5, etc.) are output at the CLKOUTP falling edge. Both the CLKOUTP rising and falling edges must be used to capture all the data bits, as shown in [Figure 155](#).

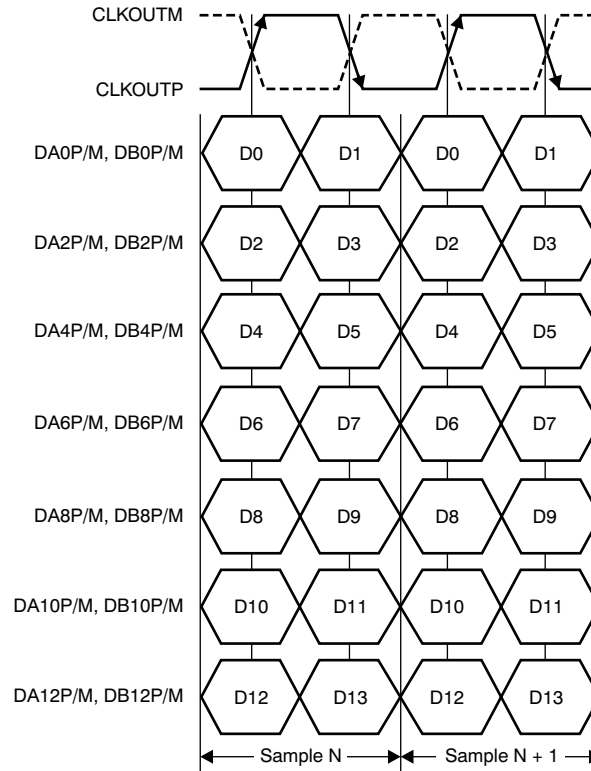
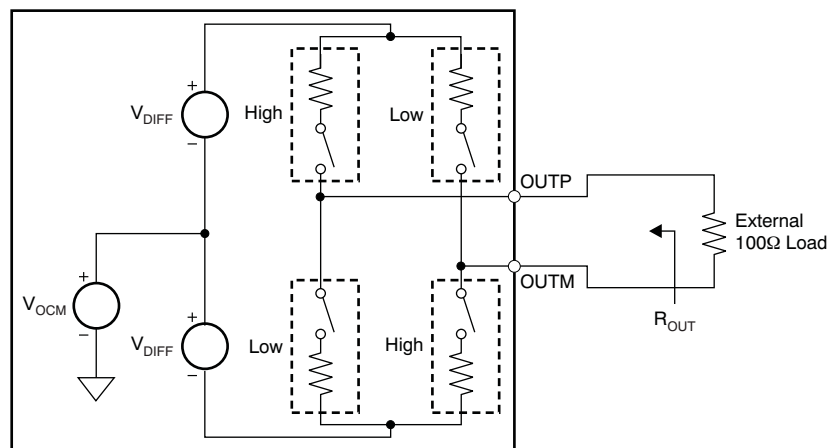

Figure 155. DDR LVDS Interface Timing

9.5.6.3 LVDS Buffer

The equivalent circuit of each LVDS output buffer is shown in Figure 156. After reset, the buffer presents an output impedance of 100 Ω to match with the external 100- Ω termination.



Default swing across 100- Ω load is ± 350 mV. Use the LVDS SWING bits to change the swing.

Figure 156. LVDS Buffer Equivalent Circuit

The V_{DIFF} voltage is nominally 350 mV, resulting in an output swing of ± 350 mV with 100- Ω external termination. The V_{DIFF} voltage is programmable using the LVDS SWING register bits from ± 125 mV to ± 570 mV.

Additionally, a mode exists to double the strength of the LVDS buffer to support 50-Ω differential termination, as shown in Figure 157. This mode can be used when the output LVDS signal is routed to two separate receiver chips, each using a 100-Ω termination. The mode can be enabled using the LVDS DATA STRENGTH and LVDS CLKOUT STRENGTH register bits for data and output clock buffers, respectively.

The buffer output impedance behaves in the same way as a source-side series termination. By absorbing reflections from the receiver end, it helps to improve signal integrity.

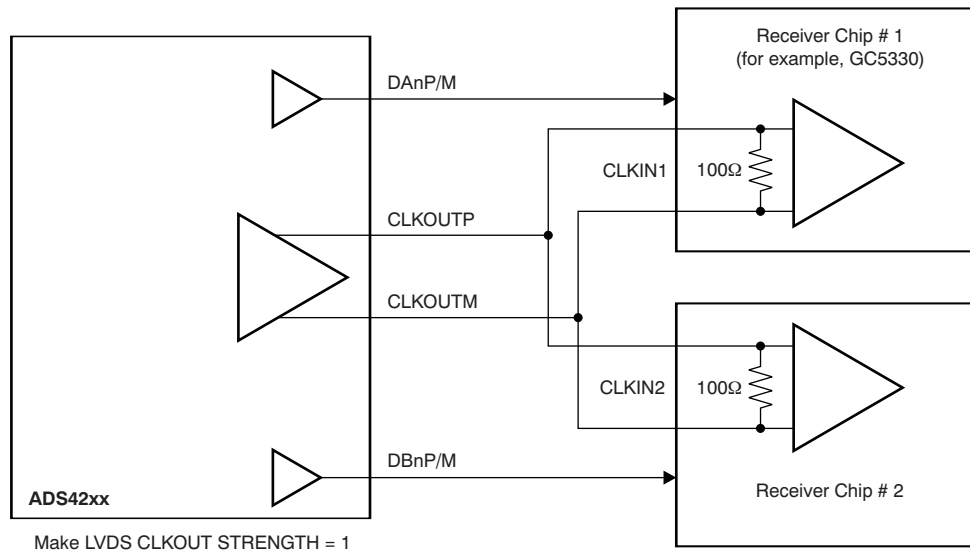

Figure 157. LVDS Buffer Differential Termination

9.5.6.4 Parallel CMOS Interface

In the CMOS mode, each data bit is output on separate pins as CMOS voltage level, every clock cycle, as Figure 158 shows. The rising edge of the output clock CLKOUT can be used to latch data in the receiver. It is recommended to minimize the load capacitance of the data and clock output pins by using short traces to the receiver. Furthermore, match the output data and clock traces to minimize the skew between them.

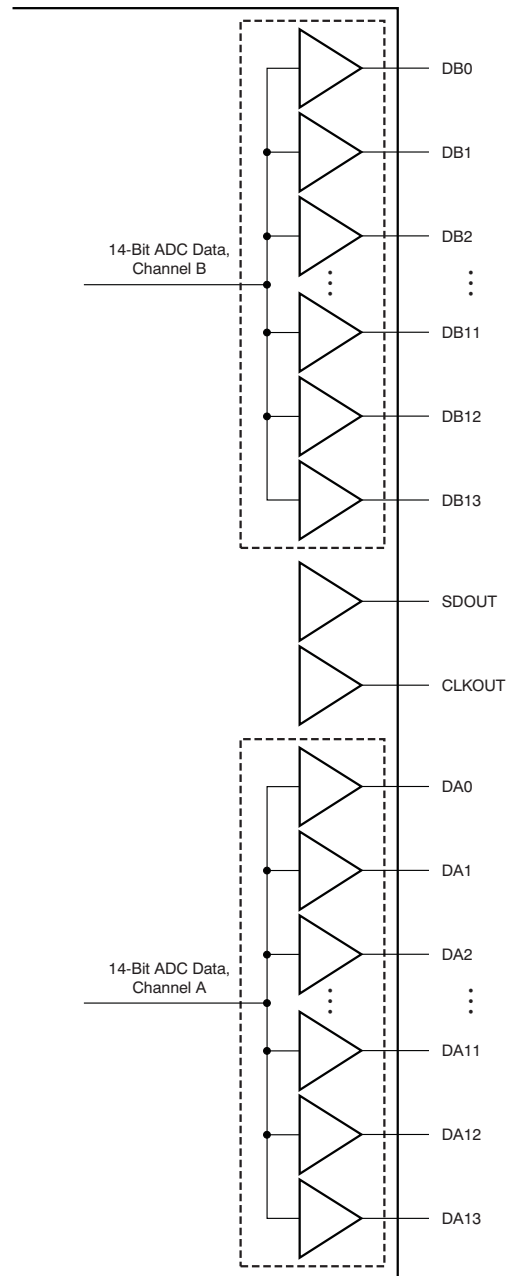

Figure 158. CMOS Outputs

9.5.6.5 CMOS Interface Power Dissipation

With CMOS outputs, the DRVDD current scales with the sampling frequency and the load capacitance on every output pin. The maximum DRVDD current occurs when each output bit toggles between 0 and 1 every clock cycle. In actual applications, this condition is unlikely to occur. The actual DRVDD current would be determined by the average number of output bits switching, which is a function of the sampling frequency and the nature of the analog input signal. This relationship is shown by the formula:

$$\text{Digital current as a result of CMOS output switching} = C_L \times \text{DRVDD} \times (N \times F_{\text{AVG}}),$$

where C_L = load capacitance, $N \times F_{\text{AVG}}$ = average number of output bits switching.

9.5.6.6 Multiplexed Mode of Operation

In this mode, the digital outputs of both channels are multiplexed and output on a single bus (DB[13:0] pins), as shown in Figure 159. The channel A output pins (DA[13:0]) are in 3-state. Because the output data rate on the DB bus is effectively doubled, this mode is recommended only for low sampling frequencies (less than 80MSPS). This mode can be enabled using the POWER-DOWN MODE register bits or using the CTRL[3:1] parallel pins.

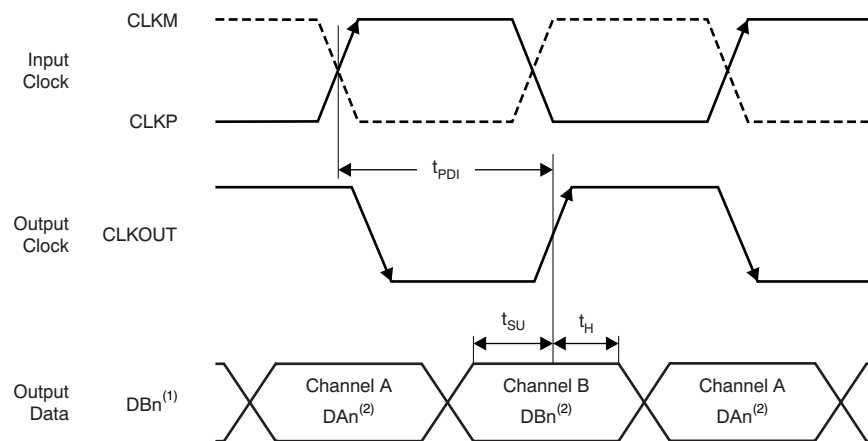

- (1) In multiplexed mode, both channels outputs come on the channel B output pins.
- (2) Dn = bits D0, D1, D2, etc.

Figure 159. Multiplexed Mode Timing Diagram

9.5.6.7 Output Data Format

Two output data formats are supported: twos complement and offset binary. The format can be selected using the DATA FORMAT serial interface register bit or by controlling the DFS pin in parallel configuration mode.

In the event of an input voltage overdrive, the digital outputs go to the appropriate full-scale level. For a positive overdrive, the output code is FFFh for the ADS422x and 3FFFh for the ADS424x in offset binary output format; the output code is 7FFh for the ADS422x and 1FFFh for the ADS424x in twos complement output format. For a negative input overdrive, the output code is 0000h in offset binary output format and 800h for the ADS422x and 2000h for the ADS424x in twos complement output format.

9.6 Register Maps

Table 12 summarizes the functions supported by the serial interface.

Table 12. Serial Interface Register Map⁽¹⁾

REGISTER ADDRESS	REGISTER DATA							
A[7:0] (Hex)	D7	D6	D5	D4	D3	D2	D1	D0
00	0	0	0	0	0	0	RESET	READOUT
01	LVDS SWING						0	0
03	0	0	0	0	0	0	HIGH PERF MODE	
25	CH A GAIN				0	CH A TEST PATTERNS		
29	0	0	0	DATA FORMAT		0	0	0
2B	CH B GAIN				0	CH B TEST PATTERNS		
3D	0	0	ENABLE OFFSET CORR	0	0	0	0	0
3F	0	0	CUSTOM PATTERN D[13:8]					
40	CUSTOM PATTERN D[7:0]							
41	LVDS CMOS		CMOS CLKOUT STRENGTH		0	0	DIS OBUF	
42	CLKOUT FALL POSN		CLKOUT RISE POSN		EN DIGITAL	0	0	0
45	STBY	LVDS CLKOUT STRENGTH	LVDS DATA STRENGTH	0	0	PDN GLOBAL	0	0
4A	0	0	0	0	0	0	0	HIGH FREQ MODE CH B ⁽²⁾
58	0	0	0	0	0	0	0	HIGH FREQ MODE CH A ⁽²⁾
BF	CH A OFFSET PEDESTAL						0	0
C1	CH B OFFSET PEDESTAL						0	0
CF	FREEZE OFFSET CORR	0	OFFSET CORR TIME CONSTANT				0	0
DB	0	0	0	0	0	0	0	LOW SPEED MODE CH B ⁽³⁾
EF	0	0	0	EN LOW SPEED MODE ⁽³⁾	0	0	0	0
F1	0	0	0	0	0	0	EN LVDS SWING	
F2	0	0	0	0	LOW SPEED MODE CH A ⁽³⁾	0	0	0

(1) Multiple functions in a register can be programmed in a single write operation. All registers default to 0 after reset.

(2) These bits improve SFDR on high frequencies. The frequency limit is 200 MHz.

(3) Low-speed mode is not applicable for the ADS4242 and ADS4222.

9.6.1 Description Of Serial Registers

7	6	5	4	3	2	1	0
0	0	0	0	0	0	RESET	READOUT

Bits[7:2] Always write 0

Bit 1 RESET: Software reset applied

This bit resets all internal registers to the default values and self-clears to 0 (default = 1).

Bit 0 READOUT: Serial readout

This bit sets the serial readout of the registers.

0 = Serial readout of registers disabled; the SDOUT pin is placed in high-impedance state.

1 = Serial readout enabled; the SDOUT pin functions as a serial data readout with CMOS logic levels running from the DRVDD supply. See the [Serial Register Readout](#) section.

7	6	5	4	3	2	1	0
LVDS SWING						0	0

Bits[7:2] LVDS SWING: LVDS swing programmability

These bits program the LVDS swing. Set the EN LVDS SWING bit to 1 before programming swing.

000000 = Default LVDS swing; ± 350 mV with external 100- Ω termination

011011 = LVDS swing increases to ± 410 mV

110010 = LVDS swing increases to ± 465 mV

010100 = LVDS swing increases to ± 570 mV

111110 = LVDS swing decreases to ± 200 mV

001111 = LVDS swing decreases to ± 125 mV

Bits[1:0] Always write 0

7	6	5	4	3	2	1	0
0	0	0	0	0	0	HIGH PERF MODE	

Bits[7:2] Always write 0

Bits[1:0] HIGH PERF MODE: High-performance mode

00 = Default performance

01 = Do not use

10 = Do not use

11 = Obtain best performance across sample clock and input signal frequencies

7	6	5	4	3	2	1	0
CH A GAIN				0	CH A TEST PATTERNS		

Bits[7:4] CH A GAIN: Channel A gain programmability

These bits set the gain programmability in 0.5-dB steps for channel A.

0000 = 0-dB gain (default after reset)

0001 = 0.5-dB gain

0010 = 1-dB gain

0011 = 1.5-dB gain

0100 = 2-dB gain

0101 = 2.5-dB gain

0110 = 3-dB gain

0111 = 3.5-dB gain

1000 = 4-dB gain

1001 = 4.5-dB gain

1010 = 5-dB gain

1011 = 5.5-dB gain

1100 = 6-dB gain

Bit 3 Always write 0
Bits[2:0] CH A TEST PATTERNS: Channel A data capture

These bits verify data capture for channel A.

000 = Normal operation

001 = Outputs all 0s

010 = Outputs all 1s

011 = Outputs toggle pattern.

For the ADS424x, output data D[13:0] are an alternating sequence of *10101010101010* and *01010101010101*.

For the ADS422x, the output data D[11:0] are an alternating sequence of *101010101010* and *010101010101*.

100 = Outputs digital ramp.

For the ADS424x, output data increment by one LSB (14-bit) every clock cycle from code 0 to code 16383.

For the ADS422x, output data increment by one LSB (12-bit) every fourth clock cycle from code 0 to code 4095.

101 = Outputs custom pattern; use registers 3Fh and 40h to set the custom pattern

110 = Unused

111 = Unused

7	6	5	4	3	2	1	0
0	0	0	DATA FORMAT		0	0	0

Bits[7:5] Always write 0
Bits[4:3] DATA FORMAT: Data format selection

00 = Twos complement

01 = Twos complement

10 = Twos complement

11 = Offset binary

Bits[2:0] Always write 0

7	6	5	4	3	2	1	0
CH B GAIN				0	CH B TEST PATTERNS		

Bits[7:4] CH B GAIN: Channel B gain programmability

These bits set the gain programmability in 0.5-dB steps for channel B.

0000 = 0-dB gain (default after reset)

0001 = 0.5-dB gain

0010 = 1-dB gain

0011 = 1.5-dB gain

0100 = 2-dB gain

0101 = 2.5-dB gain

0110 = 3-dB gain

0111 = 3.5-dB gain

1000 = 4-dB gain

1001 = 4.5-dB gain

1010 = 5-dB gain

1011 = 5.5-dB gain

1100 = 6-dB gain

Bit 3 Always write 0

Bits[2:0] CH B TEST PATTERNS: Channel B data capture

These bits verify data capture for channel B.

000 = Normal operation

001 = Outputs all 0s

010 = Outputs all 1s

011 = Outputs toggle pattern.

For the ADS424x, output data D[13:0] are an alternating sequence of *10101010101010* and *01010101010101*.

For the ADS422x, the output data D[11:0] are an alternating sequence of *101010101010* and *010101010101*.

100 = Outputs digital ramp.

For the ADS424x, output data increment by one LSB (14-bit) every clock cycle from code 0 to code 16383.

For the ADS422x, output data increment by one LSB (12-bit) every fourth clock cycle from code 0 to code 4095.

101 = Outputs custom pattern; use registers 3Fh and 40h to set the custom pattern

110 = Unused

111 = Unused

7	6	5	4	3	2	1	0
0	0	ENABLE OFFSET CORR	0	0	0	0	0

Bits[7:6] Always write 0

Bit 5 ENABLE OFFSET CORR: Offset correction setting

This bit enables the offset correction.

0 = Offset correction disabled

1 = Offset correction enabled

Bits[4:0] Always write 0

7	6	5	4	3	2	1	0
0	0	CUSTOM PATTERN D13	CUSTOM PATTERN D12	CUSTOM PATTERN D11	CUSTOM PATTERN D10	CUSTOM PATTERN D9	CUSTOM PATTERN D8

Bits[7:6] Always write 0

Bits[5:0] CUSTOM PATTERN D[13:8]

These are the six upper bits of the custom pattern available at the output instead of ADC data.

Note that for the ADS424x, the custom pattern is 14-bit. The ADS422x custom pattern is 12-bit.

7	6	5	4	3	2	1	0
CUSTOM PATTERN D7	CUSTOM PATTERN D6	CUSTOM PATTERN D5	CUSTOM PATTERN D4	CUSTOM PATTERN D3	CUSTOM PATTERN D2	CUSTOM PATTERN D1	CUSTOM PATTERN D0

Bits[7:0] CUSTOM PATTERN D[7:0]

These are the eight upper bits of the custom pattern available at the output instead of ADC data.

Note that for the ADS424x, the custom pattern is 14-bit. The ADS422x custom pattern is 12-bit; use the CUSTOM PATTERN D[13:2] register bits.

7	6	5	4	3	2	1	0
LVDS CMOS		CMOS CLKOUT STRENGTH		0	0	DIS OBUF	

Bits[7:6] LVDS CMOS: Interface selection

These bits select the interface.

00 = DDR LVDS interface

01 = DDR LVDS interface

10 = DDR LVDS interface

11 = Parallel CMOS interface

Bits[5:4] CMOS CLKOUT STRENGTH

These bits control the strength of the CMOS output clock.

00 = Maximum strength (recommended)

01 = Medium strength

10 = Low strength

11 = Very low strength

Bits[3:2] Always write 0

Bits[1:0] DIS OBUF

These bits power down data and clock output buffers for both the CMOS and LVDS output interface. When powered down, the output buffers are in 3-state.

00 = Default

01 = Power-down data output buffers for channel B

10 = Power-down data output buffers for channel A

11 = Power-down data output buffers for both channels as well as the clock output buffer

7	6	5	4	3	2	1	0
CLKOUT FALL POSN	CLKOUT RISE POSN		EN DIGITAL	0	0	0	0

Bits[7:6] CLKOUT FALL POSN

In LVDS mode:

00 = Default

01 = The falling edge of the output clock advances by 450 ps

10 = The falling edge of the output clock advances by 150 ps

11 = The falling edge of the output clock is delayed by 550 ps

In CMOS mode:

00 = Default

01 = The falling edge of the output clock is delayed by 150 ps

10 = Do not use

11 = The falling edge of the output clock advances by 100 ps

Bits[5:6] CLKOUT RISE POSN

In LVDS mode:

00 = Default

01 = The rising edge of the output clock advances by 450 ps

10 = The rising edge of the output clock advances by 150 ps

11 = The rising edge of the output clock is delayed by 250 ps

In CMOS mode:

00 = Default

01 = The rising edge of the output clock is delayed by 150 ps

10 = Do not use

11 = The rising edge of the output clock advances by 100 ps

Bit 3 EN DIGITAL: Digital function enable

0 = All digital functions disabled

1 = All digital functions (such as test patterns, gain, and offset correction) enabled

Bits[2:0] Always write 0

7	6	5	4	3	2	1	0
STBY	LVDS CLKOUT STRENGTH	LVDS DATA STRENGTH	0	0	PDN GLOBAL	0	0

Bit 7 STBY: Standby setting

0 = Normal operation
 1 = Both channels are put in standby; wakeup time from this mode is fast (typically 50 μ s).

Bit 6 LVDS CLKOUT STRENGTH: LVDS output clock buffer strength setting

0 = LVDS output clock buffer at default strength to be used with 100- Ω external termination
 1 = LVDS output clock buffer has double strength to be used with 50- Ω external termination

Bit 5 LVDS DATA STRENGTH

0 = All LVDS data buffers at default strength to be used with 100- Ω external termination
 1 = All LVDS data buffers have double strength to be used with 50- Ω external termination

Bits[4:3] Always write 0

Bit 2 PDN GLOBAL

0 = Normal operation
 1 = Total power down; all ADC channels, internal references, and output buffers are powered down. Wakeup time from this mode is slow (typically 100 μ s).

Bits[1:0] Always write 0

7	6	5	4	3	2	1	0
0	0	0	0	0	0	0	HIGH FREQ MODE CH B

Bits[7:1] Always write 0

Bit 0 HIGH FREQ MODE CH B: High-frequency mode for channel B

0 = Default
 1 = Use this mode for high input frequencies

7	6	5	4	3	2	1	0
0	0	0	0	0	0	0	HIGH FREQ MODE CH A

Bits[7:1] Always write 0

Bit 0 HIGH FREQ MODE CH A: High-frequency mode for channel A

0 = Default
 1 = Use this mode for high input frequencies

7	6	5	4	3	2	1	0
CH A OFFSET PEDESTAL						0	0

Bits[7:2] CH A OFFSET PEDESTAL: Channel A offset pedestal selection

When the offset correction is enabled, the final converged value after the offset is corrected is the ADC midcode value. A pedestal can be added to the final converged value by programming these bits. See the [Offset Correction](#) section. Channels can be independently programmed for different offset pedestals by choosing the relevant register address.

For the ADS424x, the pedestal ranges from –32 to +31, so the output code can vary from midcode-32 to midcode+32 by adding pedestal D7-D2.

For the ADS422x, the pedestal ranges from –8 to +7, so the output code can vary from midcode-8 to midcode+7 by adding pedestal D7-D4.

ADS422x (Program Bits D[7:4])

0111 = Midcode+7
 0110 = Midcode+6
 0101 = Midcode+5
 ...
 0000 = Midcode
 1111 = Midcode-1
 1110 = Midcode-2
 1101 = Midcode-3
 ...
 1000 = Midcode-8

ADS424x (Program Bits D[7:2])

011111 = Midcode+31
 011110 = Midcode+30
 011101 = Midcode+29
 ...
 000000 = Midcode
 111111 = Midcode-1
 111110 = Midcode-2
 111101 = Midcode-3
 ...
 100000 = Midcode-32

Bits[1:0] Always write 0

7	6	5	4	3	2	1	0
CH B OFFSET PEDESTAL						0	0

Bits[7:2] CH B OFFSET PEDESTAL: Channel B offset pedestal selection

When offset correction is enabled, the final converged value after the offset is corrected is the ADC midcode value. A pedestal can be added to the final converged value by programming these bits; see the [Offset Correction](#) section. Channels can be independently programmed for different offset pedestals by choosing the relevant register address.

For the ADS424x, the pedestal ranges from –32 to +31, so the output code can vary from midcode-32 to midcode+32 by adding pedestal D[7:2]. For the ADS422x, the pedestal ranges from –8 to +7, so the output code can vary from midcode-8 to midcode+7 by adding pedestal D[7:4].

ADS422x (Program Bits D[7:4])

- 0111 = Midcode+7
- 0110 = Midcode+6
- 0101 = Midcode+5
- ...
- 0000 = Midcode
- 1111 = Midcode-1
- 1110 = Midcode-2
- 1101 = Midcode-3
- ...
- 1000 = Midcode-8

ADS424x (Program Bits D[7:2])

- 011111 = Midcode+31
- 011110 = Midcode+30
- 011101 = Midcode+29
- ...
- 000000 = Midcode
- 111111 = Midcode-1
- 111110 = Midcode-2
- 111101 = Midcode-3
- ...
- 100000 = Midcode-32

Bits[1:0] Always write 0

7	6	5	4	3	2	1	0
FREEZE OFFSET CORR	0	OFFSET CORR TIME CONSTANT				0	0

Bit 7 FREEZE OFFSET CORR: Freeze offset correction setting

This bit sets the freeze offset correction estimation.

0 = Estimation of offset correction is not frozen (the EN OFFSET CORR bit must be set)

1 = Estimation of offset correction is frozen (the EN OFFSET CORR bit must be set); when frozen, the last estimated value is used for offset correction of every clock cycle. See the [Offset Correction](#) section.

Bit 6 Always write 0
Bits[5:2] OFFSET CORR TIME CONSTANT

The offset correction loop time constant in number of clock cycles. Refer to the [Offset Correction](#) section.

Bits[1:0] Always write 0

7	6	5	4	3	2	1	0
0	0	0	0	0	0	0	LOW SPEED MODE CH B

Bits[7:1] Always write 0
Bit 0 LOW SPEED MODE CH B: Channel B low-speed mode enable

This bit enables the low-speed mode for channel B. Set the EN LOW SPEED MODE bit to 1 before using this bit.

0 = Low-speed mode is disabled for channel B

1 = Low-speed mode is enabled for channel B

7	6	5	4	3	2	1	0
0	0	0	EN LOW SPEED MODE	0	0	0	0

Bits[7:5] Always write 0
Bit 4 EN LOW SPEED MODE: Enable control of low-speed mode through serial register bits (ADS42x5 and ADS42x6 only)

This bit enables the control of the low-speed mode using the LOW SPEED MODE CH B and LOW SPEED MODE CH A register bits.

0 = Low-speed mode is disabled

1 = Low-speed mode is controlled by serial register bits

Bits[3:0] Always write 0

7	6	5	4	3	2	1	0
0	0	0	0	0	0	EN LVDS SWING	

Bits[7:2] Always write 0

Bits[1:0] EN LVDS SWING: LVDS swing enable

These bits enable LVDS swing control using the LVDS SWING register bits.

00 = LVDS swing control using the LVDS SWING register bits is disabled

01 = Do not use

10 = Do not use

11 = LVDS swing control using the LVDS SWING register bits is enabled

7	6	5	4	3	2	1	0
0	0	0	0	LOW SPEED MODE CH A	0	0	0

Bits[7:4] Always write 0

Bit 3 LOW SPEED MODE CH A: Channel A low-speed mode enable

This bit enables the low-speed mode for channel A. Set the EN LOW SPEED MODE bit to 1 before using this bit.

0 = Low-speed mode is disabled for channel A

1 = Low-speed mode is enabled for channel A

Bits[2:0] Always write 0

10 Application and Implementation

NOTE

Information in the following applications sections is not part of the TI component specification, and TI does not warrant its accuracy or completeness. TI's customers are responsible for determining suitability of components for their purposes. Customers should validate and test their design implementation to confirm system functionality.

10.1 Application Information

The ADS424x/422x belong to TI's ultralow-power family of dual-channel 12-bit and 14-bit analog-to-digital converters (ADCs). At every rising edge of the input clock, the analog input signal of each channel is simultaneously sampled. The sampled signal in each channel is converted by a pipeline of low-resolution stages. In each stage, the sampled/held signal is converted by a high-speed, low-resolution, flash sub-ADC. The difference between the stage input and the quantized equivalent is gained and propagates to the next stage. At every clock, each succeeding stage resolves the sampled input with greater accuracy. The digital outputs from all stages are combined in a digital correction logic block and digitally processed to create the final code after a data latency of 16 clock cycles. The digital output is available as either DDR LVDS or parallel CMOS and coded in either straight offset binary or binary twos complement format. The dynamic offset of the first stage sub-ADC limits the maximum analog input frequency to approximately 400 MHz (with $2 \cdot V_{PP}$ amplitude) or approximately 600 MHz (with $1 \cdot V_{PP}$ amplitude).

10.2 Typical Application

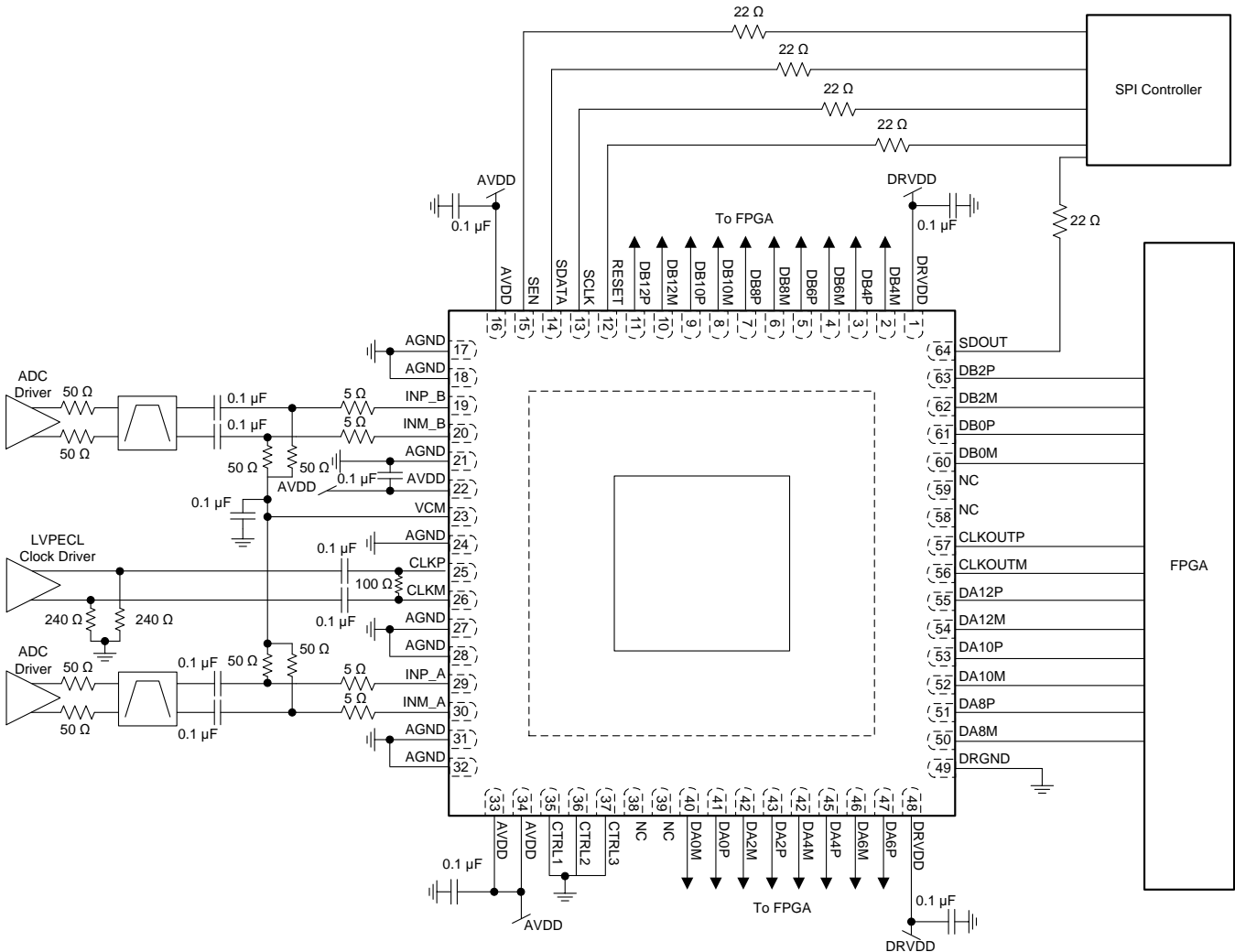

Figure 160. Example Schematic for ADS4246

10.2.1 Design Requirements

Example design requirements are listed in Table 13 for the ADC portion of the signal chain. These do not necessarily reflect the requirements of an actual system, but rather demonstrate why the ADS4246 may be chosen for a system based on a set of requirements.

Table 13. Example Design Requirements for ADS4246

Design Parameter	Example Design Requirement	ADS4246 CAPABILITY
Sampling rate	≥ 122.88 Msps to allow 80 MHz of unaliased bandwidth	Max sampling rate: 160 Msps
Input frequency	> 125 MHz to accommodate full 2nd nyquist zone	Large signal -3 dB bandwidth: 400-MHz operation
SNR	> 68 dBFS at -1 dBFS, 170 MHz	70.4 dBFS at -1 dBFS, 170 MHz
SDFR	> 77 dBc at -1 dBFS, 170 MHz	82 dBc at -1 dBFS, 170 MHz
Input full scale voltage	2 Vpp	2 Vpp
Overload recovery time	< 3 clock cycles	1 clock cycle
Digital interface	DDR LVDS	DDR LVDS
Power consumption	< 200 mW per channel	166 mW per channel

10.2.2 Detailed Design Procedure

10.2.2.1 Analog Input

The analog input of the ADS42xx is typically driven by a fully differential amplifier. The amplifier must have sufficient bandwidth for the frequencies of interest. The noise and distortion performance of the amplifier will affect the combined performance of the ADC and amplifier. The amplifier is often AC coupled to the ADC to allow both the amplifier and ADC to operate at the optimal common mode voltages. It is possible to DC couple the amplifier to the ADC if required. An alternate approach is to drive the ADC using transformers. DC coupling cannot be used with the transformer approach.

10.2.2.2 Clock Driver

The ADS42xx should be driven by a high performance clock driver such as a clock jitter cleaner. The clock needs to have low noise to maintain optimal performance. LVPECL is the most common clocking interface, but LVDS and LVCMOS can be used as well. It is not advised to drive the clock input from an FPGA unless the noise degradation can be tolerated, such as for input signals near DC where the clock noise impact is minimal.

10.2.2.3 Digital Interface

The ADS42xx supports both LVDS and CMOS interfaces. The LVDS interface should be used for best performance when operating at maximum sampling rate. The LVDS outputs can be connected directly to the FPGA without any additional components. When using CMOS outputs resistors should be placed in series with the outputs to reduce the output current spikes to limit the performance degradation. The resistors should be large enough to limit current spikes but not so large as to significantly distort the digital output waveform. An external CMOS buffer should be used when driving distances greater than a few inches to reduce ground bounce within the ADC.

10.2.2.4 SNR and Clock Jitter

The signal-to-noise ratio (SNR) of the ADC is limited by three different factors, as shown in [Equation 1](#). Quantization noise is typically not noticeable in pipeline converters and is 96 dBFS for a 16-bit ADC. Thermal noise limits SNR at low input frequencies and clock jitter sets SNR for higher input frequencies.

$$\text{SNR}_{\text{ADC}}[\text{dBc}] = -20 \times \log \sqrt{\left(10 - \frac{\text{SNR}_{\text{Quantization_Noise}}}{20}\right)^2 + \left(10 - \frac{\text{SNR}_{\text{ThermalNoise}}}{20}\right)^2 + \left(10 - \frac{\text{SNR}_{\text{Jitter}}}{20}\right)^2} \quad (1)$$

SNR limitation is a result of sample clock jitter and can be calculated by [Equation 2](#)

$$\text{SNR}_{\text{Jitter}}[\text{dBc}] = -20 \times \log(2\pi \times f_{\text{IN}} \times t_{\text{jitter}}) \quad (2)$$

The total clock jitter (T_{Jitter}) has three components: the internal aperture jitter ($85 f_s$ for the device) is set by the noise of the clock input buffer, the external clock jitter, and the jitter from the analog input signal. T_{Jitter} can be calculated by [Equation 3](#):

$$T_{\text{Jitter}} = \sqrt{(T_{\text{Jitter,Ext.Clock_Input}})^2 + (T_{\text{Aperture_ADC}})^2} \quad (3)$$

External clock jitter can be minimized by using high-quality clock sources and jitter cleaners as well as band-pass filters at the clock input while a faster clock slew rate improved ADC aperture jitter. The device has a 74.1-dBFS thermal noise and an $85\text{-}f_s$ internal aperture jitter. The SNR value depends on the amount of external jitter for different input frequencies, as shown in Figure.

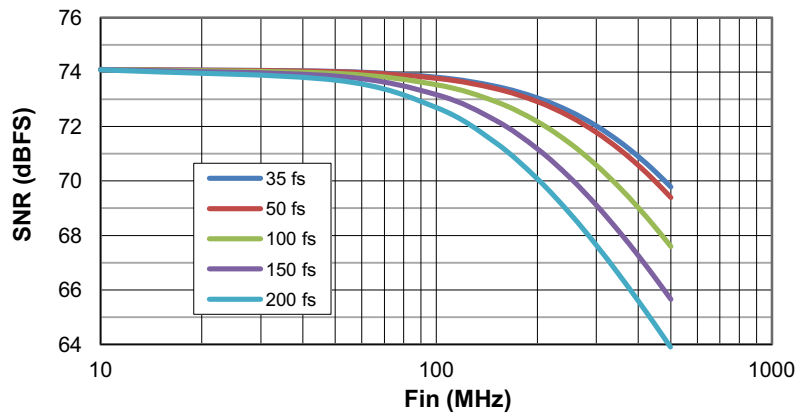
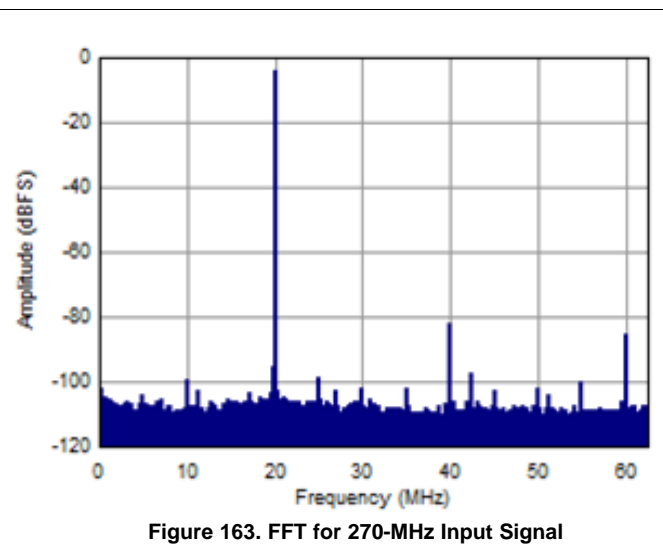
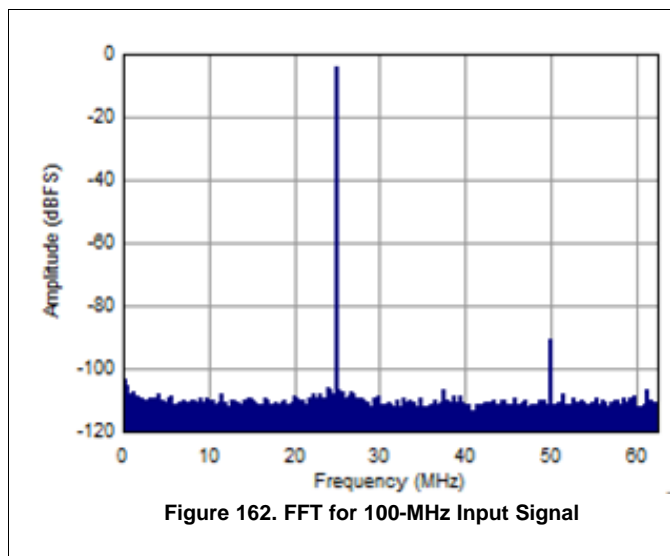

Figure 161. SNR versus Input Frequency and External Clock Jitter

10.2.3 Application Curves

Figure 162 and Figure 163 show performance obtained at 100-MHz and 270-MHz input frequencies, respectively, using the appropriate driving circuit.



11 Power Supply Recommendations

The ADS42xx has two power supplies, one analog (AVDD) and one digital (DRVDD) supply. Both supplies have a nominal voltage of 1.8 V. The AVDD supply is noise sensitive and the digital supply is not.

11.1 Sharing DRVDD and AVDD Supplies

For best performance, the AVDD supply should be driven by a low noise linear regulator (LDO) and separated from the DRVDD supply. It is possible to have AVDD and DRVDD share a single supply, but they should be isolated by a ferrite bead and bypass capacitors in a PI-filter configuration, at a minimum. The digital noise will be concentrated at the sampling frequency and harmonics of the sampling frequency and could contain noise related to the sampled signal. While developing schematics, it is a good idea to leave extra placeholders for additional supply filtering.

11.2 Using DC/DC Power Supplies

DC/DC switching power supplies can be used to power DRVDD without issue. It is also possible to power AVDD from a switching regulator. Noise and spurs on the AVDD power supply will affect the SNR and SFDR of the ADC and will show up near DS and as a modulated component around the input frequency. If a switching regulator is used, then it should be designed to have minimal voltage ripple. Supply filtering should be used to limit the amount of spurious noise at the AVDD supply pins. Extra placeholders should be placed on the schematic for additional filtering. Optimization of filtering in the final system will likely be needed to achieve the desired performance. The choice of power supply ultimately depends on the system requirements. For instance, if very low phase noise is required then use of a switching regulator is not recommended.

11.3 Power Supply Bypassing

Because the ADS42xx already includes internal decoupling, minimal external decoupling can be used without loss in performance. Note that decoupling capacitors can help filter external power-supply noise. Thus, the optimum number of capacitors depends on the actual application. A 0.1- μ F capacitor is recommended near each supply pin. The decoupling capacitors should be placed very close to the converter supply pins.

12 Layout

12.1 Layout Guidelines

12.1.1 Grounding

A single ground plane is sufficient to give good performance, provided the analog, digital, and clock sections of the board are cleanly partitioned. See the [ADS4226 Evaluation Module \(SLAU333\)](#) for details on layout and grounding.

12.1.2 Supply Decoupling

Because the ADS424x/422x already includes internal decoupling, minimal external decoupling can be used without loss in performance. Note that decoupling capacitors can help filter external power-supply noise; thus, the optimum number of capacitors depends on the actual application. The decoupling capacitors should be placed very close to the converter supply pins.

12.1.3 Exposed Pad

In addition to providing a path for heat dissipation, the PowerPAD is also electrically connected internally to the digital ground. Therefore, it is necessary to solder the exposed pad to the ground plane for best thermal and electrical performance. For detailed information, see application notes [QFN Layout Guidelines \(SLOA122\)](#) and [QFN/SON PCB Attachment \(SLUA271\)](#), both available for download at www.ti.com.

12.1.4 Routing Analog Inputs

It is advisable to route differential analog input pairs (INP_x and INM_x) close to each other. To minimize the possibility of coupling from a channel analog input to the sampling clock, the analog input pairs of both channels should be routed perpendicular to the sampling clock. See the [ADS4226 Evaluation Module \(SLAU333\)](#) for reference routing. [Figure 164](#) shows a snapshot of the PCB layout from the ADS424x EVM.

12.2 Layout Example

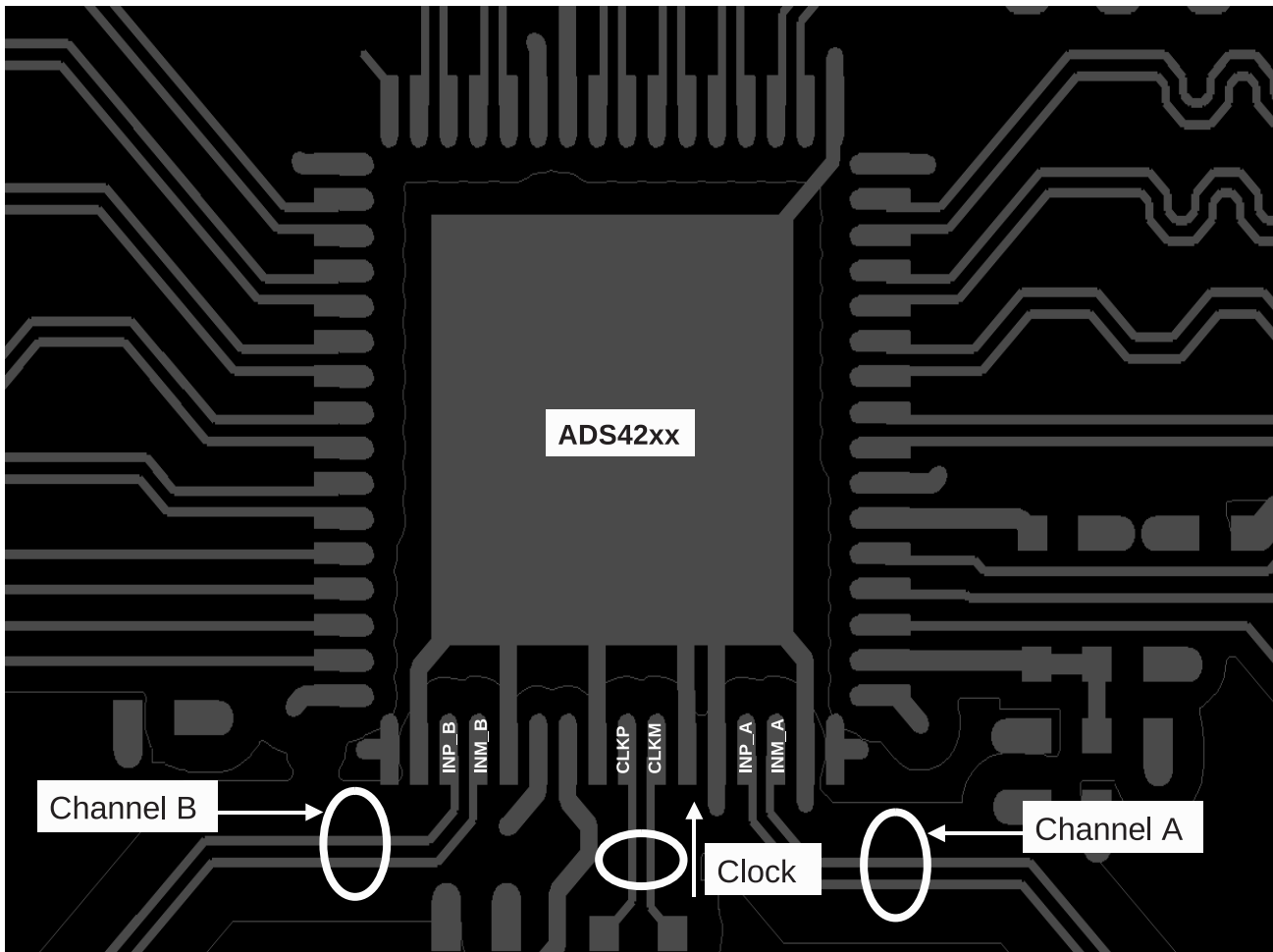

Figure 164. ADS42xx EVM PCB Layout

13 Device and Documentation Support

13.1 Device Support

13.1.1 Device Nomenclature

Analog Bandwidth – The analog input frequency at which the power of the fundamental is reduced by 3 dB with respect to the low-frequency value.

Aperture Delay – The delay in time between the rising edge of the input sampling clock and the actual time at which the sampling occurs. This delay is different across channels. The maximum variation is specified as aperture delay variation (channel-to-channel).

Aperture Uncertainty (Jitter) – The sample-to-sample variation in aperture delay.

Clock Pulse Width/Duty Cycle – The duty cycle of a clock signal is the ratio of the time the clock signal remains at a logic high (clock pulse width) to the period of the clock signal. Duty cycle is typically expressed as a percentage. A perfect differential sine-wave clock results in a 50% duty cycle.

Maximum Conversion Rate – The maximum sampling rate at which specified operation is given. All parametric testing is performed at this sampling rate unless otherwise noted.

Minimum Conversion Rate – The minimum sampling rate at which the ADC functions.

Differential Nonlinearity (DNL) – An ideal ADC exhibits code transitions at analog input values spaced exactly 1LSB apart. The DNL is the deviation of any single step from this ideal value, measured in units of LSBs.

Integral Nonlinearity (INL) – The INL is the deviation of the ADC transfer function from a best fit line determined by a least squares curve fit of that transfer function, measured in units of LSBs.

Gain Error – Gain error is the deviation of the ADC actual input full-scale range from its ideal value. The gain error is given as a percentage of the ideal input full-scale range. Gain error has two components: error as a result of reference inaccuracy (E_{GREF}) and error as a result of the channel (E_{GCHAN}). Both errors are specified independently as E_{GREF} and E_{GCHAN} .

To a first-order approximation, the total gain error is $E_{TOTAL} \sim E_{GREF} + E_{GCHAN}$.

For example, if $E_{TOTAL} = \pm 0.5\%$, the full-scale input varies from $(1 - 0.5/100) \times FS_{ideal}$ to $(1 + 0.5/100) \times FS_{ideal}$.

Offset Error – The offset error is the difference, given in number of LSBs, between the ADC actual average idle channel output code and the ideal average idle channel output code. This quantity is often mapped into millivolts.

Temperature Drift – The temperature drift coefficient (with respect to gain error and offset error) specifies the change per degree Celsius of the parameter from T_{MIN} to T_{MAX} . It is calculated by dividing the maximum deviation of the parameter across the T_{MIN} to T_{MAX} range by the difference $T_{MAX} - T_{MIN}$.

Signal-to-Noise Ratio – SNR is the ratio of the power of the fundamental (P_S) to the noise floor power (P_N), excluding the power at dc and the first nine harmonics.

$$SNR = 10 \log_{10} \frac{P_S}{P_N} \quad (4)$$

SNR is either given in units of dBc (dB to carrier) when the absolute power of the fundamental is used as the reference, or dBFS (dB to full-scale) when the power of the fundamental is extrapolated to the converter full-scale range.

Signal-to-Noise and Distortion (SINAD) – SINAD is the ratio of the power of the fundamental (P_S) to the power of all the other spectral components including noise (P_N) and distortion (P_D), but excluding dc.

$$SINAD = 10 \log_{10} \frac{P_S}{P_N + P_D} \quad (5)$$

SINAD is either given in units of dBc (dB to carrier) when the absolute power of the fundamental is used as the reference, or dBFS (dB to full-scale) when the power of the fundamental is extrapolated to the converter full-scale range.

Device Support (continued)

Effective Number of Bits (ENOB) – ENOB is a measure of the converter performance as compared to the theoretical limit based on quantization noise.

$$\text{ENOB} = \frac{\text{SINAD} - 1.76}{6.02} \quad (6)$$

Total Harmonic Distortion (THD) – THD is the ratio of the power of the fundamental (P_S) to the power of the first nine harmonics (P_D).

$$\text{THD} = 10\text{Log}^{10} \frac{P_S}{P_N} \quad (7)$$

THD is typically given in units of dBc (dB to carrier).

Spurious-Free Dynamic Range (SFDR) – The ratio of the power of the fundamental to the highest other spectral component (either spur or harmonic). SFDR is typically given in units of dBc (dB to carrier).

Two-Tone Intermodulation Distortion – IMD3 is the ratio of the power of the fundamental (at frequencies f_1 and f_2) to the power of the worst spectral component at either frequency $2f_1 - f_2$ or $2f_2 - f_1$. IMD3 is either given in units of dBc (dB to carrier) when the absolute power of the fundamental is used as the reference, or dBFS (dB to full-scale) when the power of the fundamental is extrapolated to the converter full-scale range.

DC Power-Supply Rejection Ratio (DC PSRR) – DC PSRR is the ratio of the change in offset error to a change in analog supply voltage. The dc PSRR is typically given in units of mV/V.

AC Power-Supply Rejection Ratio (AC PSRR) – AC PSRR is the measure of rejection of variations in the supply voltage by the ADC. If ΔV_{SUP} is the change in supply voltage and ΔV_{OUT} is the resultant change of the ADC output code (referred to the input), then:

$$\text{PSRR} = 20\text{Log}^{10} \frac{\Delta V_{\text{OUT}}}{\Delta V_{\text{SUP}}} \quad (\text{Expressed in dBc}) \quad (8)$$

Voltage Overload Recovery – The number of clock cycles taken to recover to less than 1% error after an overload on the analog inputs. This is tested by separately applying a sine wave signal with 6 dB positive and negative overload. The deviation of the first few samples after the overload (from the expected values) is noted.

Common-Mode Rejection Ratio (CMRR) – CMRR is the measure of rejection of variation in the analog input common-mode by the ADC. If $\Delta V_{\text{CM_IN}}$ is the change in the common-mode voltage of the input pins and ΔV_{OUT} is the resulting change of the ADC output code (referred to the input), then:

$$\text{CMRR} = 20\text{Log}^{10} \frac{\Delta V_{\text{OUT}}}{\Delta V_{\text{CM}}} \quad (\text{Expressed in dBc}) \quad (9)$$

Crosstalk (only for multi-channel ADCs) – This is a measure of the internal coupling of a signal from an adjacent channel into the channel of interest. It is specified separately for coupling from the immediate neighboring channel (near-channel) and for coupling from channel across the package (far-channel). It is usually measured by applying a full-scale signal in the adjacent channel. Crosstalk is the ratio of the power of the coupling signal (as measured at the output of the channel of interest) to the power of the signal applied at the adjacent channel input. It is typically expressed in dBc.

13.2 Documentation Support

13.2.1 Related Documentation

For related documentation, see the following:

- QFN Layout Guidelines ([SLOA122](#))
- QFN/SON PCB Attachment ([SLUA271](#))
- ADS42xx Evaluation Module ([SLAU333A](#))

13.3 Related Links

The table below lists quick access links. Categories include technical documents, support and community resources, tools and software, and quick access to sample or buy.

Table 14. Related Links

PARTS	PRODUCT FOLDER	SAMPLE & BUY	TECHNICAL DOCUMENTS	TOOLS & SOFTWARE	SUPPORT & COMMUNITY
ADS4222	Click here	Click here	Click here	Click here	Click here
ADS4225	Click here	Click here	Click here	Click here	Click here
ADS4226	Click here	Click here	Click here	Click here	Click here
ADS4242	Click here	Click here	Click here	Click here	Click here
ADS4245	Click here	Click here	Click here	Click here	Click here
ADS4246	Click here	Click here	Click here	Click here	Click here

13.4 Community Resources

The following links connect to TI community resources. Linked contents are provided "AS IS" by the respective contributors. They do not constitute TI specifications and do not necessarily reflect TI's views; see TI's [Terms of Use](#).

TI E2E™ Online Community *TI's Engineer-to-Engineer (E2E) Community*. Created to foster collaboration among engineers. At e2e.ti.com, you can ask questions, share knowledge, explore ideas and help solve problems with fellow engineers.

Design Support *TI's Design Support* Quickly find helpful E2E forums along with design support tools and contact information for technical support.

13.5 Trademarks

E2E is a trademark of Texas Instruments.
All other trademarks are the property of their respective owners.

13.6 Electrostatic Discharge Caution



These devices have limited built-in ESD protection. The leads should be shorted together or the device placed in conductive foam during storage or handling to prevent electrostatic damage to the MOS gates.

13.7 Glossary

[SLYZ022](#) — *TI Glossary*.

This glossary lists and explains terms, acronyms, and definitions.

14 Mechanical, Packaging, and Orderable Information

The following pages include mechanical, packaging, and orderable information. This information is the most current data available for the designated devices. This data is subject to change without notice and revision of this document. For browser-based versions of this data sheet, refer to the left-hand navigation.

PACKAGING INFORMATION

Orderable Device	Status (1)	Package Type	Package Drawing	Pins	Package Qty	Eco Plan (2)	Lead finish/ Ball material (6)	MSL Peak Temp (3)	Op Temp (°C)	Device Marking (4/5)	Samples
ADS4222IRGCR	ACTIVE	VQFN	RGC	64	2000	RoHS & Green	NIPDAU	Level-3-260C-168 HR	-40 to 85	AZ4222	Samples
ADS4222IRGCT	ACTIVE	VQFN	RGC	64	250	RoHS & Green	NIPDAU	Level-3-260C-168 HR	-40 to 85	AZ4222	Samples
ADS4225IRGCR	ACTIVE	VQFN	RGC	64	2000	RoHS & Green	NIPDAU	Level-3-260C-168 HR	-40 to 85	AZ4225	Samples
ADS4225IRGCT	ACTIVE	VQFN	RGC	64	250	RoHS & Green	NIPDAU	Level-3-260C-168 HR	-40 to 85	AZ4225	Samples
ADS4226IRGCR	ACTIVE	VQFN	RGC	64	2000	RoHS & Green	NIPDAU	Level-3-260C-168 HR	-40 to 85	AZ4226	Samples
ADS4226IRGCT	ACTIVE	VQFN	RGC	64	250	RoHS & Green	NIPDAU	Level-3-260C-168 HR	-40 to 85	AZ4226	Samples
ADS4242IRGCR	ACTIVE	VQFN	RGC	64	2000	RoHS & Green	NIPDAU	Level-3-260C-168 HR	-40 to 85	AZ4242	Samples
ADS4242IRGCT	ACTIVE	VQFN	RGC	64	250	RoHS & Green	NIPDAU	Level-3-260C-168 HR	-40 to 85	AZ4242	Samples
ADS4245IRGCR	ACTIVE	VQFN	RGC	64	2000	RoHS & Green	NIPDAU	Level-3-260C-168 HR	-40 to 85	AZ4245	Samples
ADS4245IRGCT	ACTIVE	VQFN	RGC	64	250	RoHS & Green	NIPDAU	Level-3-260C-168 HR	-40 to 85	AZ4245	Samples
ADS4246IRGCR	ACTIVE	VQFN	RGC	64	2000	RoHS & Green	NIPDAU	Level-3-260C-168 HR	-40 to 85	AZ4246	Samples
ADS4246IRGCT	ACTIVE	VQFN	RGC	64	250	RoHS & Green	NIPDAU	Level-3-260C-168 HR	-40 to 85	AZ4246	Samples

(1) The marketing status values are defined as follows:

ACTIVE: Product device recommended for new designs.

LIFEBUY: TI has announced that the device will be discontinued, and a lifetime-buy period is in effect.

NRND: Not recommended for new designs. Device is in production to support existing customers, but TI does not recommend using this part in a new design.

PREVIEW: Device has been announced but is not in production. Samples may or may not be available.

OBSOLETE: TI has discontinued the production of the device.

(2) **RoHS:** TI defines "RoHS" to mean semiconductor products that are compliant with the current EU RoHS requirements for all 10 RoHS substances, including the requirement that RoHS substance do not exceed 0.1% by weight in homogeneous materials. Where designed to be soldered at high temperatures, "RoHS" products are suitable for use in specified lead-free processes. TI may reference these types of products as "Pb-Free".

RoHS Exempt: TI defines "RoHS Exempt" to mean products that contain lead but are compliant with EU RoHS pursuant to a specific EU RoHS exemption.

Green: TI defines "Green" to mean the content of Chlorine (Cl) and Bromine (Br) based flame retardants meet JS709B low halogen requirements of <=1000ppm threshold. Antimony trioxide based flame retardants must also meet the <=1000ppm threshold requirement.

- (3) MSL, Peak Temp. - The Moisture Sensitivity Level rating according to the JEDEC industry standard classifications, and peak solder temperature.
- (4) There may be additional marking, which relates to the logo, the lot trace code information, or the environmental category on the device.
- (5) Multiple Device Markings will be inside parentheses. Only one Device Marking contained in parentheses and separated by a "-" will appear on a device. If a line is indented then it is a continuation of the previous line and the two combined represent the entire Device Marking for that device.
- (6) Lead finish/Ball material - Orderable Devices may have multiple material finish options. Finish options are separated by a vertical ruled line. Lead finish/Ball material values may wrap to two lines if the finish value exceeds the maximum column width.

Important Information and Disclaimer:The information provided on this page represents TI's knowledge and belief as of the date that it is provided. TI bases its knowledge and belief on information provided by third parties, and makes no representation or warranty as to the accuracy of such information. Efforts are underway to better integrate information from third parties. TI has taken and continues to take reasonable steps to provide representative and accurate information but may not have conducted destructive testing or chemical analysis on incoming materials and chemicals. TI and TI suppliers consider certain information to be proprietary, and thus CAS numbers and other limited information may not be available for release.

In no event shall TI's liability arising out of such information exceed the total purchase price of the TI part(s) at issue in this document sold by TI to Customer on an annual basis.

OTHER QUALIFIED VERSIONS OF ADS4245 :

- Enhanced Product: [ADS4245-EP](#)

NOTE: Qualified Version Definitions:

- Enhanced Product - Supports Defense, Aerospace and Medical Applications

TAPE AND REEL INFORMATION

QUADRANT ASSIGNMENTS FOR PIN 1 ORIENTATION IN TAPE

*All dimensions are nominal

Device	Package Type	Package Drawing	Pins	SPQ	Reel Diameter (mm)	Reel Width W1 (mm)	A0 (mm)	B0 (mm)	K0 (mm)	P1 (mm)	W (mm)	Pin1 Quadrant
ADS4222IRGCR	VQFN	RGC	64	2000	330.0	16.4	9.3	9.3	1.5	12.0	16.0	Q2
ADS4225IRGCR	VQFN	RGC	64	2000	330.0	16.4	9.3	9.3	1.5	12.0	16.0	Q2
ADS4226IRGCR	VQFN	RGC	64	2000	330.0	16.4	9.3	9.3	1.5	12.0	16.0	Q2
ADS4242IRGCR	VQFN	RGC	64	2000	330.0	16.4	9.3	9.3	1.5	12.0	16.0	Q2
ADS4245IRGCR	VQFN	RGC	64	2000	330.0	16.4	9.3	9.3	1.5	12.0	16.0	Q2
ADS4246IRGCR	VQFN	RGC	64	2000	330.0	16.4	9.3	9.3	1.5	12.0	16.0	Q2

TAPE AND REEL BOX DIMENSIONS

*All dimensions are nominal

Device	Package Type	Package Drawing	Pins	SPQ	Length (mm)	Width (mm)	Height (mm)
ADS4222IRGCR	VQFN	RGC	64	2000	350.0	350.0	43.0
ADS4225IRGCR	VQFN	RGC	64	2000	350.0	350.0	43.0
ADS4226IRGCR	VQFN	RGC	64	2000	350.0	350.0	43.0
ADS4242IRGCR	VQFN	RGC	64	2000	350.0	350.0	43.0
ADS4245IRGCR	VQFN	RGC	64	2000	350.0	350.0	43.0
ADS4246IRGCR	VQFN	RGC	64	2000	350.0	350.0	43.0

GENERIC PACKAGE VIEW

RGC 64

VQFN - 1 mm max height

9 x 9, 0.5 mm pitch

PLASTIC QUAD FLATPACK - NO LEAD

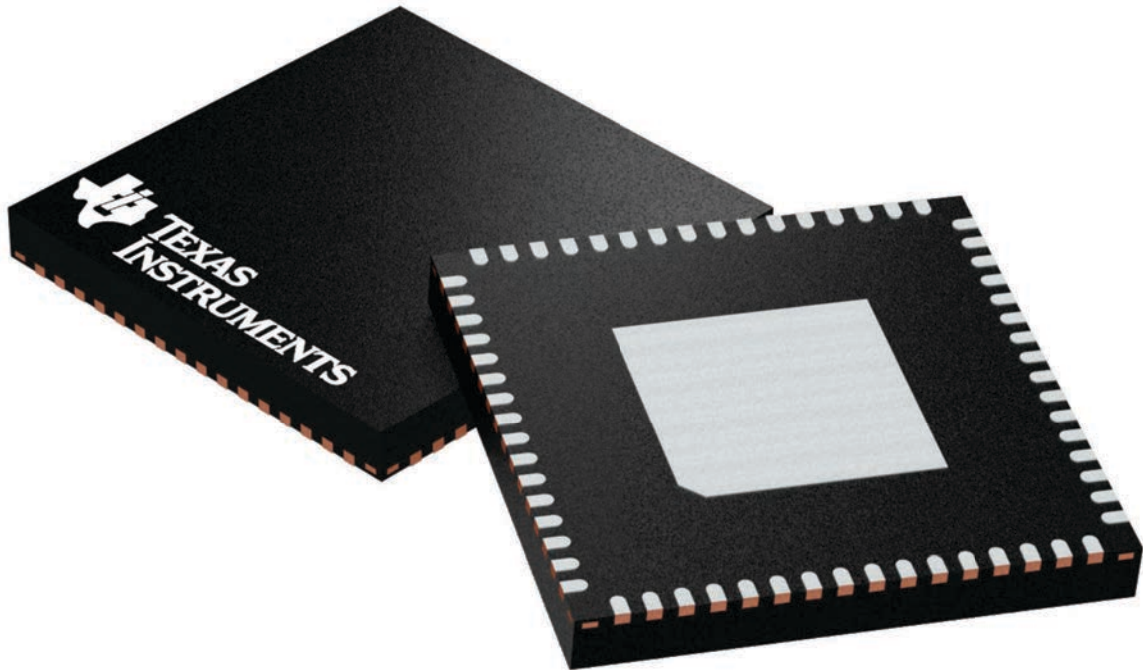

Images above are just a representation of the package family, actual package may vary.
Refer to the product data sheet for package details.

4224597/A

RGC0064H

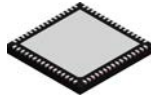

PACKAGE OUTLINE

VQFN - 1 mm max height

PLASTIC QUAD FLATPACK - NO LEAD

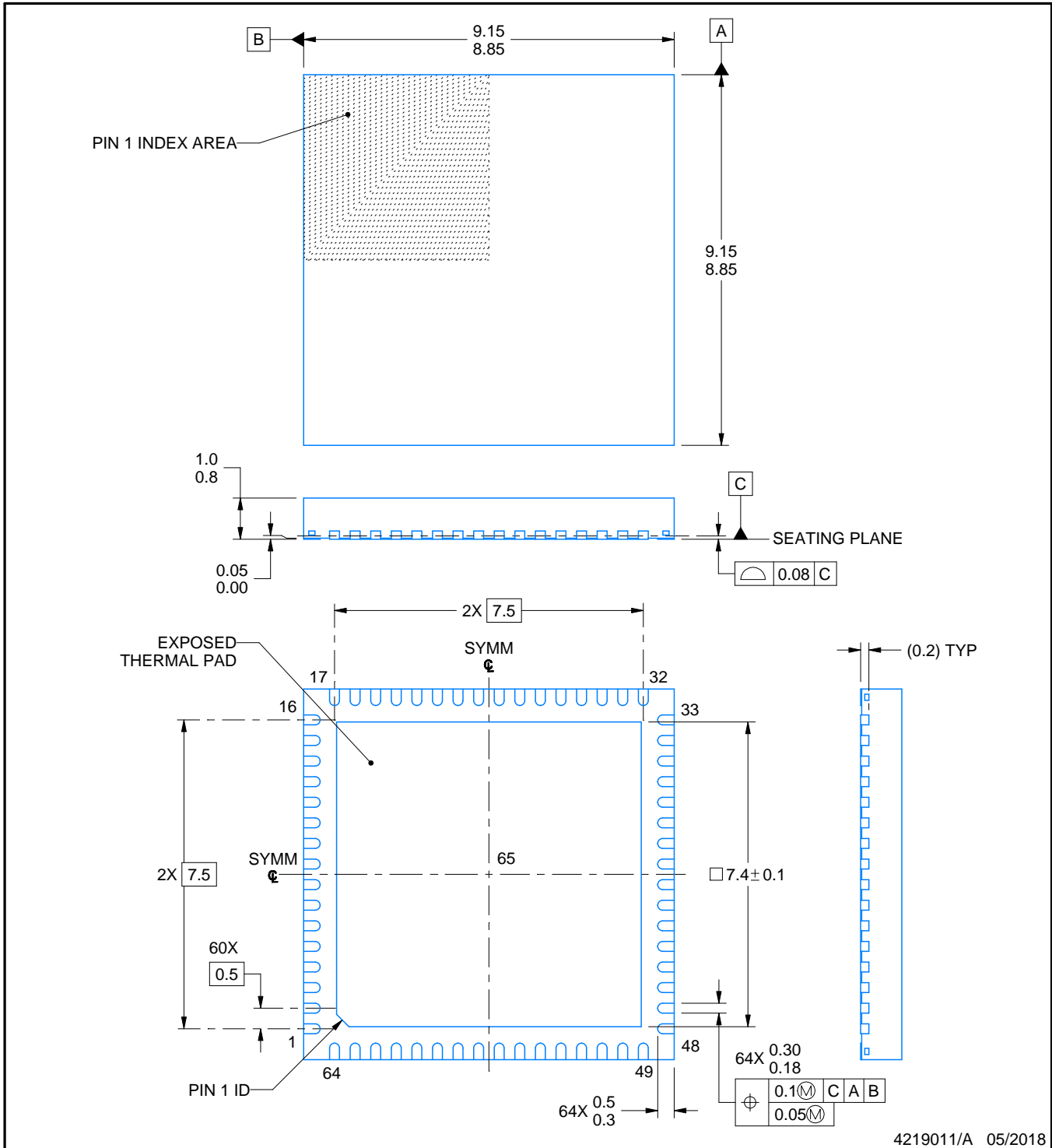

NOTES:

1. All linear dimensions are in millimeters. Any dimensions in parenthesis are for reference only. Dimensioning and tolerancing per ASME Y14.5M.
2. This drawing is subject to change without notice.
3. The package thermal pad must be soldered to the printed circuit board for thermal and mechanical performance.

EXAMPLE BOARD LAYOUT

RGC0064H

VQFN - 1 mm max height

PLASTIC QUAD FLATPACK - NO LEAD

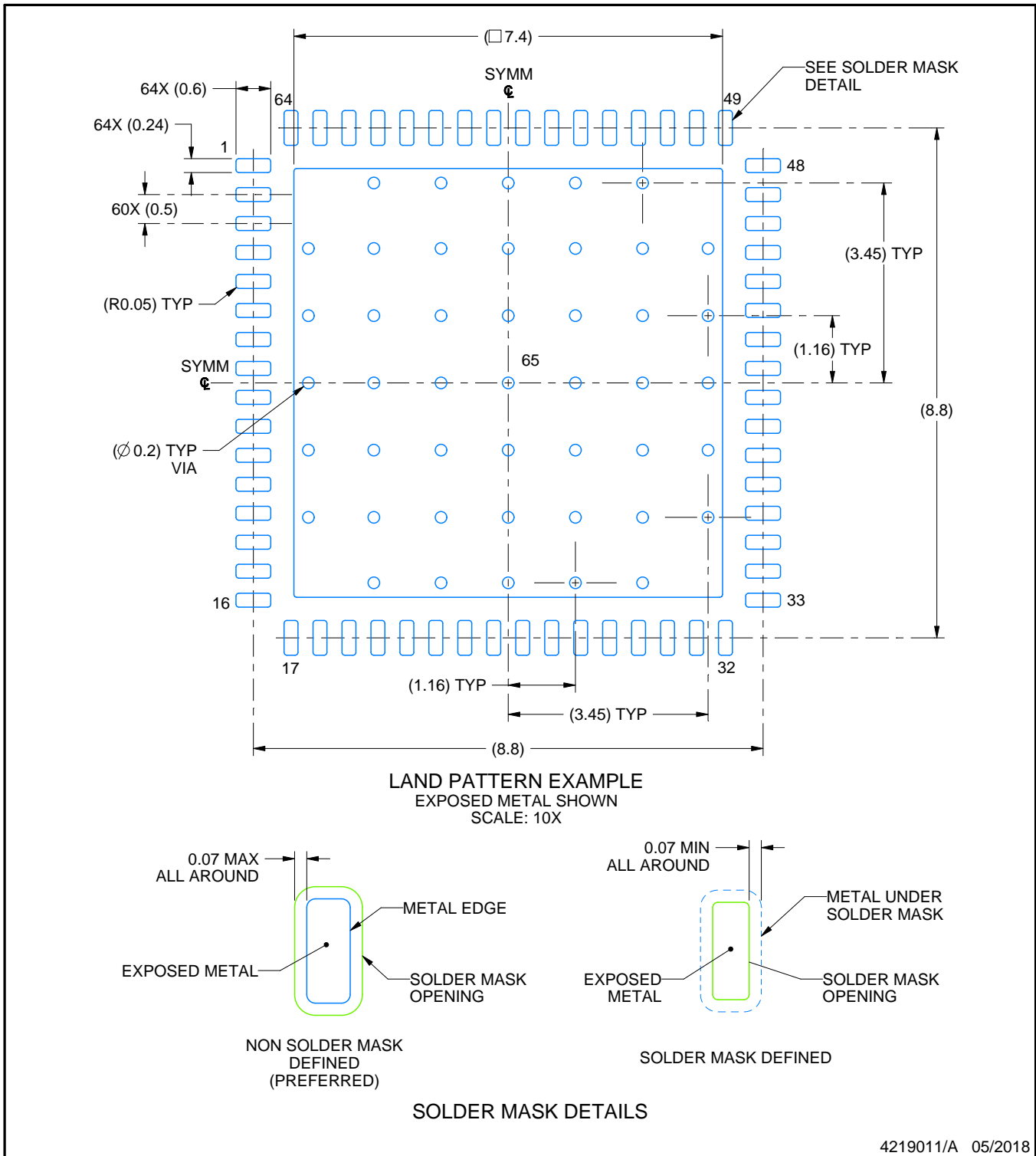

NOTES: (continued)

4. This package is designed to be soldered to a thermal pad on the board. For more information, see Texas Instruments literature number SLUA271 (www.ti.com/lit/sluea271).
5. Vias are optional depending on application, refer to device data sheet. If any vias are implemented, refer to their locations shown on this view. It is recommended that vias under paste be filled, plugged or tented.

EXAMPLE STENCIL DESIGN

RGC0064H

VQFN - 1 mm max height

PLASTIC QUAD FLATPACK - NO LEAD

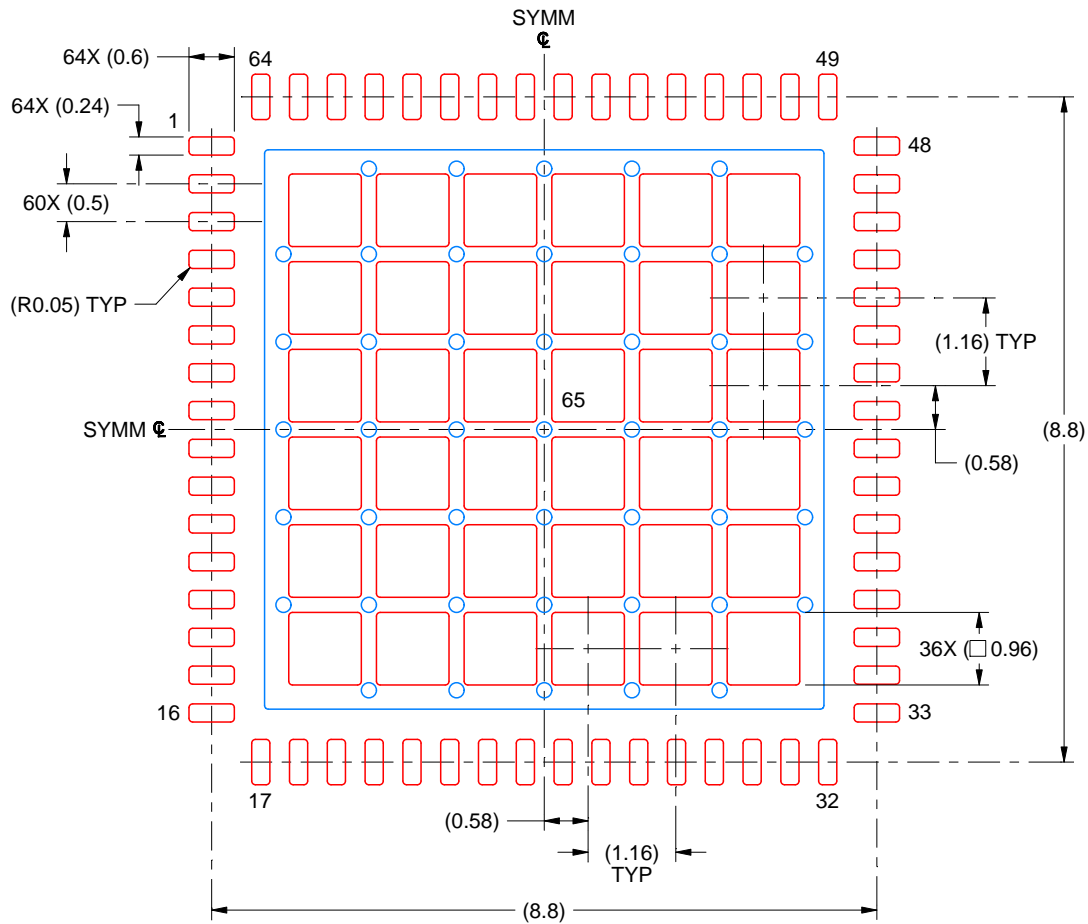

SOLDER PASTE EXAMPLE
 BASED ON 0.125 MM THICK STENCIL
 SCALE: 10X

EXPOSED PAD 65
 61% PRINTED SOLDER COVERAGE BY AREA UNDER PACKAGE

4219011/A 05/2018

NOTES: (continued)

6. Laser cutting apertures with trapezoidal walls and rounded corners may offer better paste release. IPC-7525 may have alternate design recommendations.

IMPORTANT NOTICE AND DISCLAIMER

TI PROVIDES TECHNICAL AND RELIABILITY DATA (INCLUDING DATASHEETS), DESIGN RESOURCES (INCLUDING REFERENCE DESIGNS), APPLICATION OR OTHER DESIGN ADVICE, WEB TOOLS, SAFETY INFORMATION, AND OTHER RESOURCES "AS IS" AND WITH ALL FAULTS, AND DISCLAIMS ALL WARRANTIES, EXPRESS AND IMPLIED, INCLUDING WITHOUT LIMITATION ANY IMPLIED WARRANTIES OF MERCHANTABILITY, FITNESS FOR A PARTICULAR PURPOSE OR NON-INFRINGEMENT OF THIRD PARTY INTELLECTUAL PROPERTY RIGHTS.

These resources are intended for skilled developers designing with TI products. You are solely responsible for (1) selecting the appropriate TI products for your application, (2) designing, validating and testing your application, and (3) ensuring your application meets applicable standards, and any other safety, security, or other requirements. These resources are subject to change without notice. TI grants you permission to use these resources only for development of an application that uses the TI products described in the resource. Other reproduction and display of these resources is prohibited. No license is granted to any other TI intellectual property right or to any third party intellectual property right. TI disclaims responsibility for, and you will fully indemnify TI and its representatives against, any claims, damages, costs, losses, and liabilities arising out of your use of these resources.

TI's products are provided subject to TI's Terms of Sale (<https://www.ti.com/legal/termsofsale.html>) or other applicable terms available either on [ti.com](https://www.ti.com) or provided in conjunction with such TI products. TI's provision of these resources does not expand or otherwise alter TI's applicable warranties or warranty disclaimers for TI products.

Mailing Address: Texas Instruments, Post Office Box 655303, Dallas, Texas 75265
Copyright © 2021, Texas Instruments Incorporated