



QUADBAND MMIC VCO 8.3 - 15.2 GHz

Typical Applications

Low noise QUADBAND MMIC VCO for:

- Test Equipment & Industrial Controls
- VSAT Radio
- Point to Point/Multi-Point Radio
- Military End-Use

Features

- Dual Output: RF1 = -5 to +6 dBm
RF2 = -15 to -4 dBm
- Four Independent VCO's with common RF & Tuning ports
- No External Resonator Needed
- 40 Lead 6x6mm SMT Package: 36mm²

General Description

The HMC8074LP6GE is a QUADBAND MMIC VCO that integrates the resonators, negative resistance devices, varactor diodes, and features two RF output pins. The VCO's phase noise performance is excellent over temperature, shock, and process due to the oscillator's monolithic structure. With a +4.75V supply, the output power is typically -5 to +6 dBm for each RF output, respectively. The voltage controlled oscillator is packaged in a leadless QFN 6x6 mm surface mount package, and requires no external matching components.

Functional Diagram

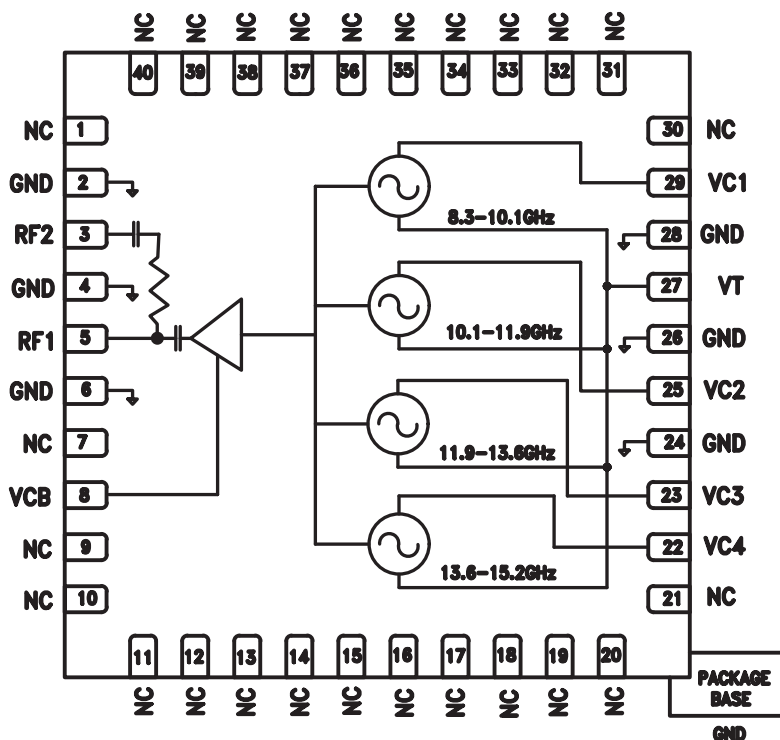



QUADBAND MMIC VCO 8.3 - 15.2 GHz

Electrical Specifications, $T_A = -40\text{ }^\circ\text{C}$ to $+85\text{ }^\circ\text{C}$, $V_{CC} = +4.75\text{V}$

Parameter		Min.	Typ.	Max.	Units
Frequency Range	Band 1	8.3 - 10.1			GHz
	Band 2	10.1 - 11.9			
	Band 3	11.9 - 13.6			
	Band 4	13.6 - 15.2			
Tuning Sensitivity	Band 1	75	200	850	MHz/V
	Band 2	75	225	950	
	Band 3	100	250	1050	
	Band 4	120	275	1150	
Power Output	RF1	-5	0	+6	dBm
	RF2	-15	-10	-4	
SSB Phase Noise	Band 1	10kHz	-76	-71	dBc/Hz
		100kHz	-104	-100	
		1MHz	-130	-127	
	Band 2	10kHz	-74	-69	
		100kHz	-102	-98	
		1MHz	-129	-126	
	Band 3	10kHz	-71	-66	
		100kHz	-100	-96	
		1MHz	-128	-125	
	Band 4	10kHz	-68	-63	
		100kHz	-98	-94	
		1MHz	-127	-124	
Supply Voltage		4.50	4.75	5.00	V
Total Supply Current (ICB + ICx) (VCB = VCx = +4.75V) [1]			60	90	mA
Tune Voltage (VTUNE)		0.5		13.0	V
Tune Port Leakage Current (VTUNE = 13V)				40	μA
Output Return Loss (RF1)			13		dB
Output Return Loss (RF2)			7.5		dB
Harmonics (RF1 & RF2)	2nd		15		dBc
	3rd		24		dBc
Pulling (into a 2.0:1 VSWR)			.25		MHz pp
Pushing (VTUNE = 5V)			20		MHz/V
Frequency Drift Rate	Band 1		1.0		MHz/ $^\circ\text{C}$
	Band 2		1.2		
	Band 3		1.4		
	Band 4		1.4		

[1] Total supply current is for the output buffer and one VCO band.
Only one VCO band must be powered at a time.



QUADBAND MMIC VCO
8.3 - 15.2 GHz

TYPICAL DATA, VCC=4.75V, BAND 1

Frequency vs. Tuning Voltage

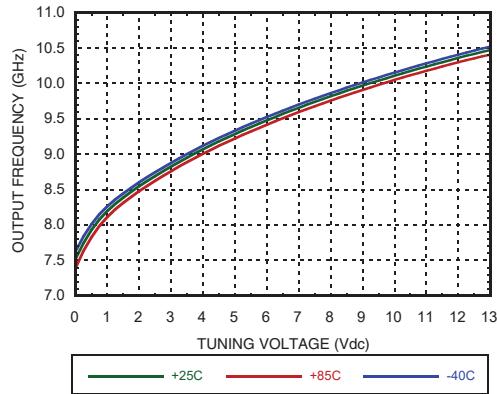

Output Power vs. Tuning Voltage

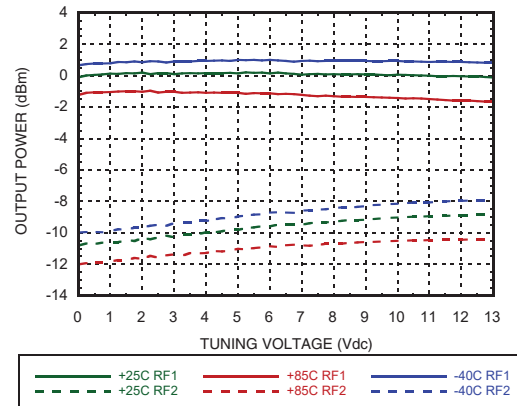

Sensitivity vs. Tuning Voltage

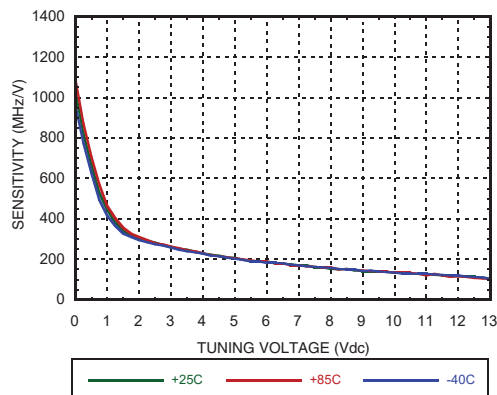

Supply Current vs. Tuning Voltage

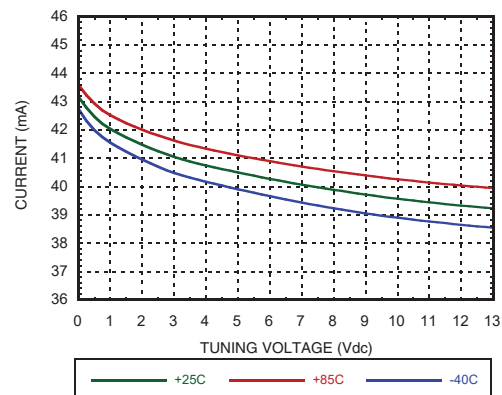

SSB Phase Noise vs. Tuning Voltage

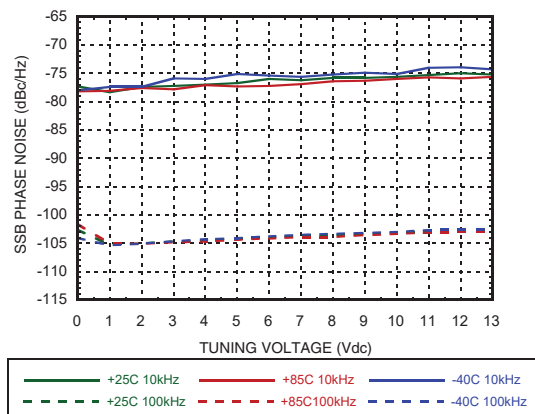

SSB Phase Noise @ Vtune = +5V

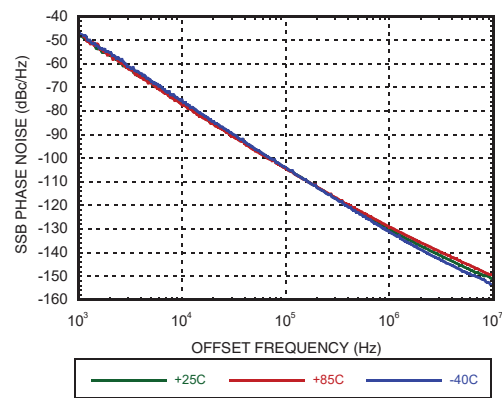



QUADBAND MMIC VCO
8.3 - 15.2 GHz

TYPICAL DATA, VCC=4.75V, BAND 2

Frequency vs. Tuning Voltage

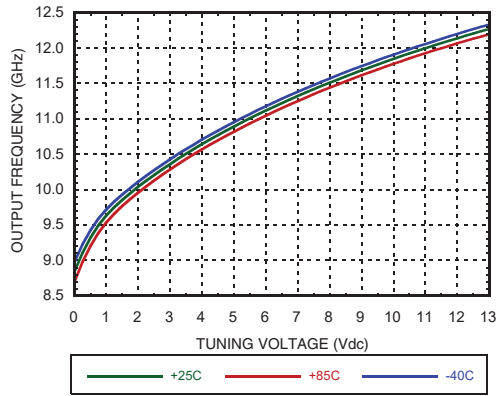

Output Power vs. Tuning Voltage

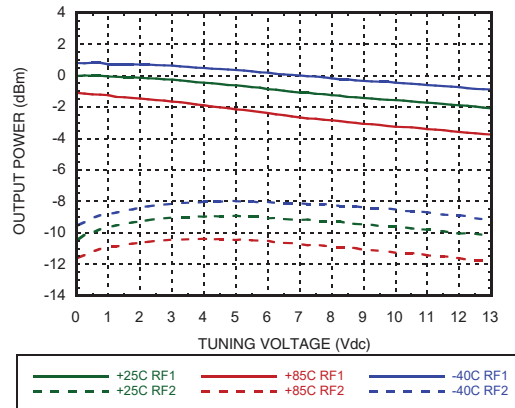

Sensitivity vs. Tuning Voltage

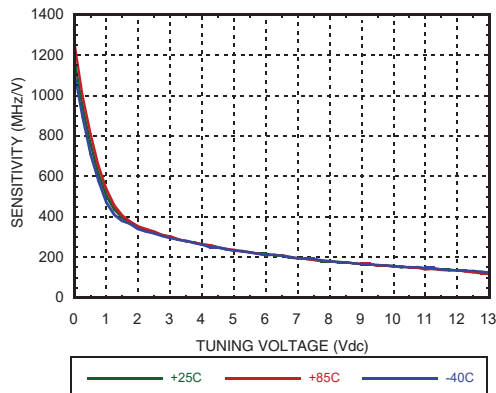

Supply Current vs. Tuning Voltage

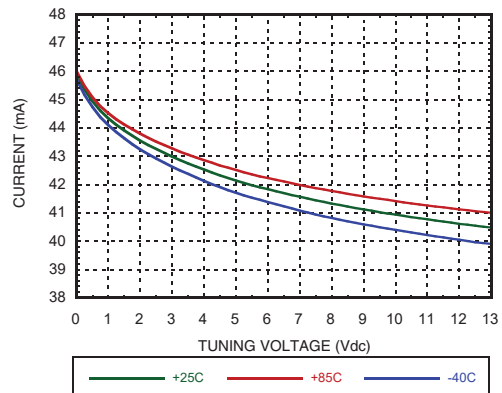

SSB Phase Noise vs. Tuning Voltage

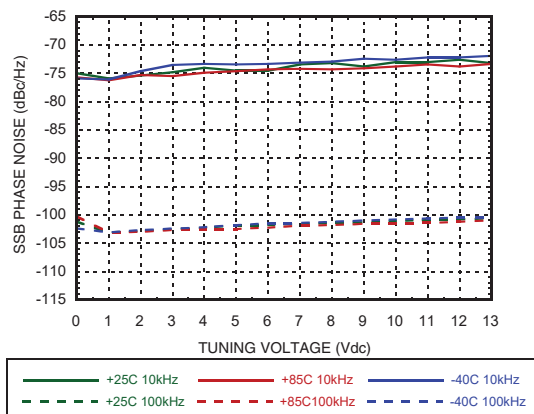

SSB Phase Noise @ Vtune = +5V

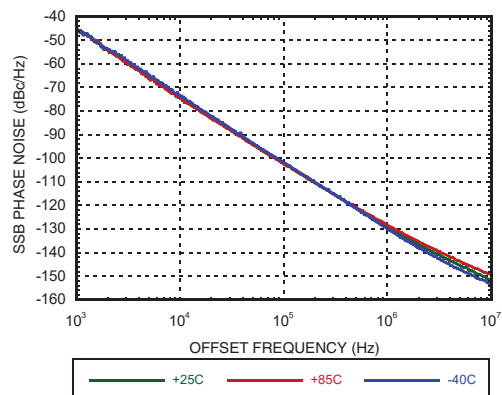



QUADBAND MMIC VCO
8.3 - 15.2 GHz

TYPICAL DATA, VCC=4.75V, BAND 3

Frequency vs. Tuning Voltage

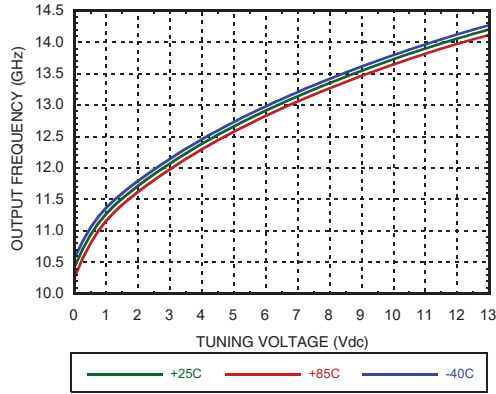

Output Power vs. Tuning Voltage

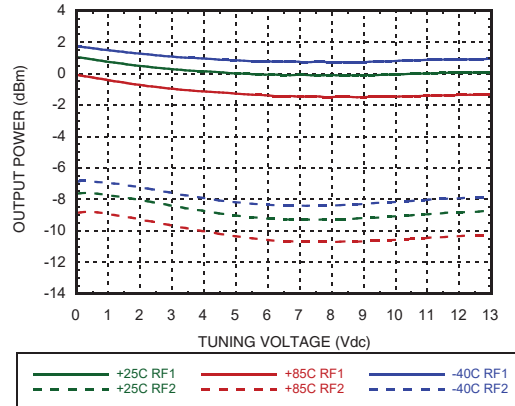

Sensitivity vs. Tuning Voltage

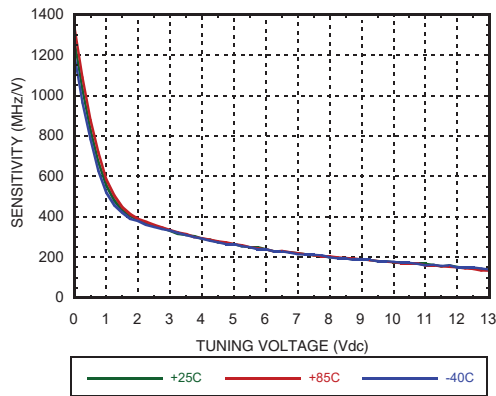

Supply Current vs. Tuning Voltage

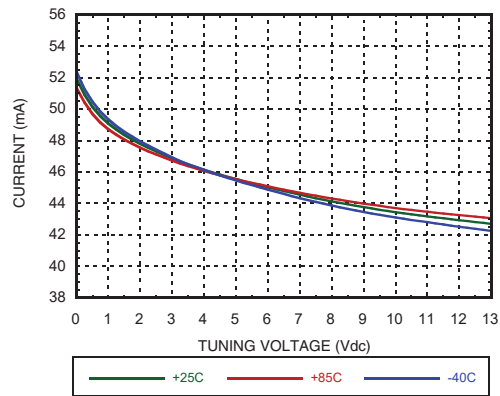

SSB Phase Noise vs. Tuning Voltage

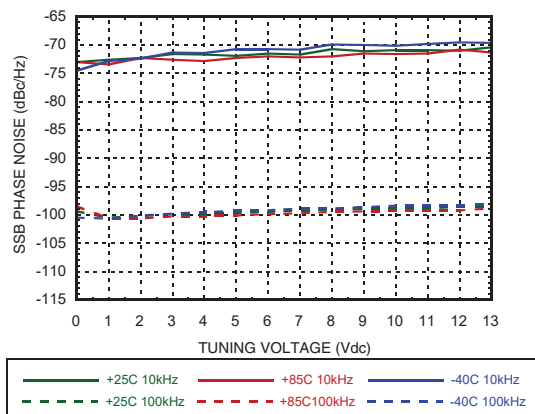

SSB Phase Noise @ Vtune = +5V

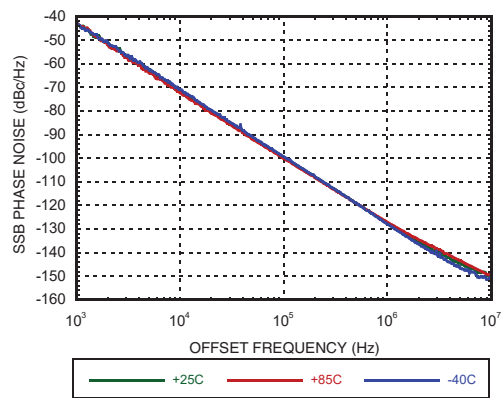



QUADBAND MMIC VCO
8.3 - 15.2 GHz

TYPICAL DATA, VCC=4.75V, BAND 4

Frequency vs. Tuning Voltage

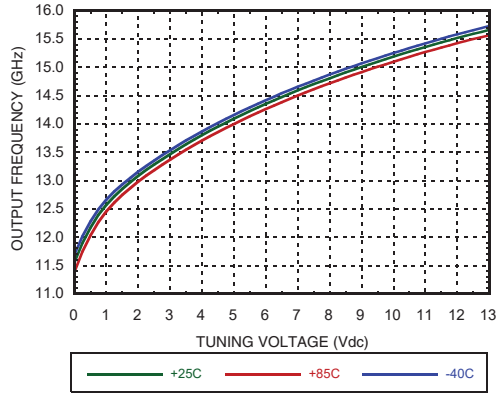

Output Power vs. Tuning Voltage

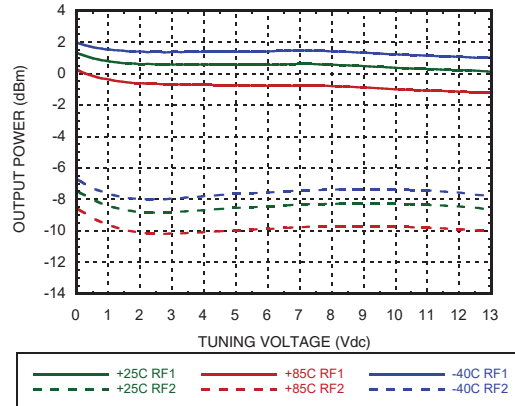

Sensitivity vs. Tuning Voltage

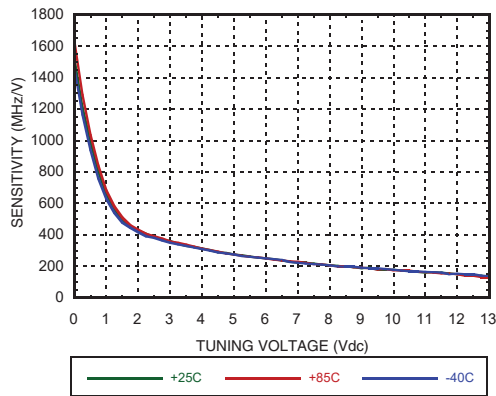

Supply Current vs. Tuning Voltage

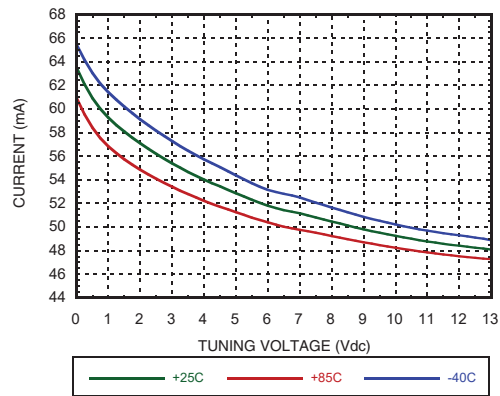

SSB Phase Noise vs. Tuning Voltage

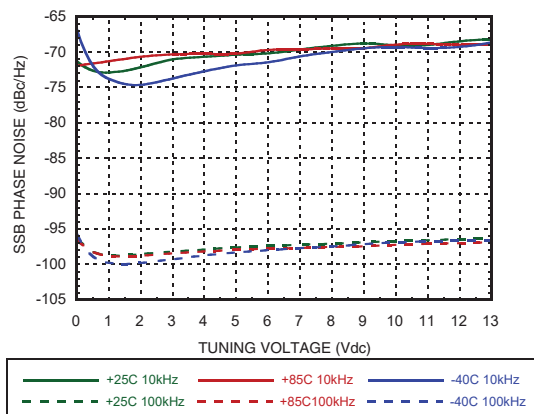

SSB Phase Noise @ Vtune = +5V

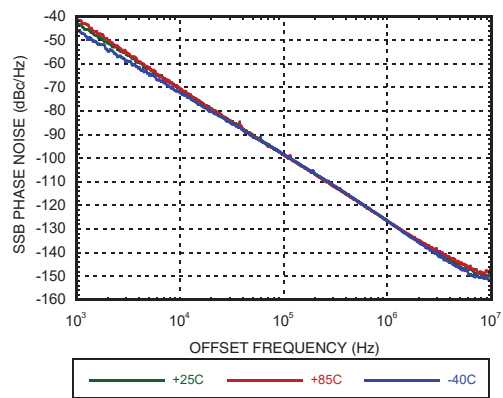



Absolute Maximum Ratings

Vcc	+5.25 Vdc
Vtune	0 to 15
Storage Temperature	-65 to +150 °C
ESD Sensitivity (HBM)	CLASS 1A
ESD Sensitivity (CDM)	CLASS C1

Reliability Information

Junction Temperature To Maintain 1 Million Hour MTTF	135 °C
Nominal Junction Temperature (T = +85 °C)	105 °C
Thermal Resistance (junction to ground paddle)	70 °C/W
Operating Temperature	-40 to +85 °C

Typical Supply Current vs. Vcc, +25C, Band 1

Vcc (V)	Icc (mA)
4.50	35
4.75	40
5.00	45

Typical Supply Current vs. Vcc, +25C, Band 2

Vcc (V)	Icc (mA)
4.50	36
4.75	42
5.00	46

Typical Supply Current vs. Vcc, +25C, Band 3

Vcc (V)	Icc (mA)
4.50	39
4.75	45
5.00	50

Typical Supply Current vs. Vcc, +25C, Band 4

Vcc (V)	Icc (mA)
4.50	45
4.75	51
5.00	58



**ELECTROSTATIC SENSITIVE DEVICE
OBSERVE HANDLING PRECAUTIONS**



QUADBAND MMIC VCO 8.3 - 15.2 GHz

Pin Descriptions

Pin Number	Function	Description	Interface Schematic
1, 7, 9 - 21, 30 - 40	N/C	No Connection. These pins may be connected to RF/DC ground. Performance will not be affected.	
2, 4, 6, 24, 26, 28, Paddle	GND	Package bottom has an exposed metal paddle that must be connected to RF/DC ground.	
3	RF2	Coupled Low Power RF Output (AC coupled).	
5	RF1	Primary RF Output (AC coupled).	
8	VCB	Buffer Supply Voltage, +4.75V	
22	VC4	Supply Voltage, BAND 4, +4.75V	
23	VC3	Supply Voltage, BAND 3, +4.75V	
25	VC2	Supply Voltage, BAND 2, +4.75V	
29	VC1	Supply Voltage, BAND 1, +4.75V	
27	VTUNE	Control Voltage Input. Modulation port bandwidth dependent on drive source impedance.	

Outline Drawing

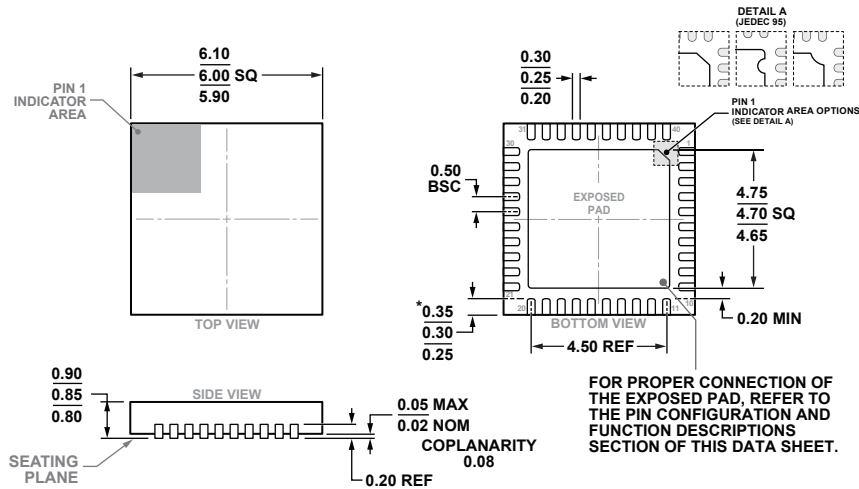

*COMPLIANT TO JEDEC STANDARDS MO-220-VJJD-5 WITH EXCEPTION TO LEAD LENGTH

40-Lead Lead Frame Chip Scale Package [LFCSP]
 6 mm x 6 mm Body and 0.85 mm Package Height
 (HCP-40-1)
 Dimensions shown in millimeters

Package Information

Part Number	Package Body Material	Lead Finish	MSL Rating	Package Marking [2]
HMC8074LP6GE	RoHS-compliant Low Stress Injection Molded Plastic	100% matte Sn	MSL3 [1]	H8074 XXXX
HMC8074LP6GETR	RoHS-compliant Low Stress Injection Molded Plastic	100% matte Sn	MSL3 [1]	H8074 XXXX

[1] Max peak reflow temperature of 260 °C

[2] 4-Digit lot number XXXX

**NOTES:**