



## CY62146G MoBL<sup>®</sup> Automotive

# 4-Mbit (256K words × 16 bit) Static RAM with Error-Correcting Code (ECC)

### Features

- AEC-Q100 qualified
- High speed: 45 ns
- Temperature Range
  - Automotive-A: -40 °C to +85 °C
- Ultra-low standby power
  - Typical standby current: 3.5 μA
- Embedded ECC for single-bit error correction<sup>[1]</sup>
- Voltage range: 2.2 V to 3.6 V, 4.5 V to 5.5 V
- 1.0-V data retention
- TTL-compatible inputs and outputs
- Pb-free 44-pin TSOP II package

### Functional Description

CY62146G is high-performance CMOS low-power (MoBL) SRAM devices with embedded ECC.

Device is accessed by asserting the chip enable ( $\overline{CE}$ ) input LOW.

Data writes are performed by asserting the Write Enable ( $\overline{WE}$ ) input LOW, while providing the data on I/O<sub>0</sub> through I/O<sub>15</sub> and address on A<sub>0</sub> through A<sub>17</sub> pins. The Byte High Enable (BHE) and Byte Low Enable ( $\overline{BLE}$ ) inputs control write operations to the upper and lower bytes of the specified memory location. BHE controls I/O<sub>8</sub> through I/O<sub>15</sub> and  $\overline{BLE}$  controls I/O<sub>0</sub> through I/O<sub>7</sub>.

Data reads are performed by asserting the Output Enable ( $\overline{OE}$ ) input and providing the required address on the address lines. Read data is accessible on the I/O lines (I/O<sub>0</sub> through I/O<sub>15</sub>). Byte accesses can be performed by asserting the required byte enable signal (BHE or  $\overline{BLE}$ ) to read either the upper byte or the lower byte of data from the specified address location.

All I/Os (I/O<sub>0</sub> through I/O<sub>15</sub>) are placed in a HI-Z state when the device is deselected ( $\overline{CE}$  HIGH), or control signals are de-asserted ( $\overline{OE}$ ,  $\overline{BLE}$ , BHE).

The logic block diagram is on page 2.

### Product Portfolio

Product	Features and Options (see Pin Configuration – CY62146G on page 4)	Range	V <sub>CC</sub> Range (V)	Speed (ns)	Power Dissipation			
					Operating I <sub>CC</sub> (mA)		Standby, I <sub>SB2</sub> (μA)	
					f = f <sub>max</sub>			
					Typ <sup>[2]</sup>	Max	Typ <sup>[2]</sup>	Max
CY62146G30	Single Chip Enable	Automotive-A	2.2 V–3.6 V	45	15	20	3.5	8.7
CY62146G			4.5 V–5.5 V					

#### Notes

1. This device does not support automatic write-back on error detection.
2. Typical values are included for reference only and are not guaranteed or tested. Typical values are measured at V<sub>CC</sub> = 3 V (for V<sub>CC</sub> range of 2.2 V–3.6 V) and V<sub>CC</sub> = 5 V (for V<sub>CC</sub> range of 4.5 V–5.5 V), T<sub>A</sub> = 25 °C.

**Logic Block Diagram – CY62146G**

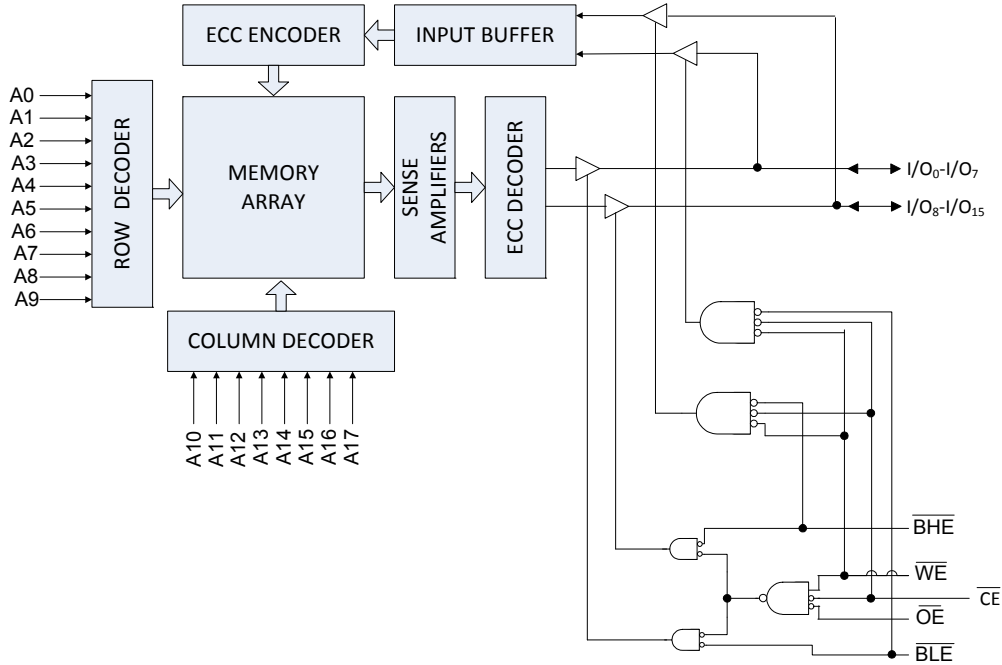

## Contents

<b>Pin Configuration – CY62146G</b> .....	<b>4</b>	Ordering Code Definitions .....	15
<b>Maximum Ratings</b> .....	<b>5</b>	<b>Package Diagrams</b> .....	<b>16</b>
<b>Operating Range</b> .....	<b>5</b>	<b>Acronyms</b> .....	<b>17</b>
<b>DC Electrical Characteristics</b> .....	<b>5</b>	<b>Document Conventions</b> .....	<b>17</b>
<b>Capacitance</b> .....	<b>7</b>	Units of Measure .....	17
<b>Thermal Resistance</b> .....	<b>7</b>	<b>Document History Page</b> .....	<b>18</b>
<b>AC Test Loads and Waveforms</b> .....	<b>7</b>	<b>Sales, Solutions, and Legal Information</b> .....	<b>19</b>
<b>Data Retention Characteristics</b> .....	<b>8</b>	Worldwide Sales and Design Support .....	19
<b>Data Retention Waveform</b> .....	<b>8</b>	Products .....	19
<b>AC Switching Characteristics</b> .....	<b>9</b>	PSoC@Solutions .....	19
<b>Switching Waveforms</b> .....	<b>10</b>	Cypress Developer Community .....	19
<b>Truth Table – CY62146G</b> .....	<b>14</b>	Technical Support .....	19
<b>Ordering Information</b> .....	<b>15</b>		

### Pin Configuration – CY62146G

Figure 1. 44-pin TSOP II pinout – CY62146G [3]

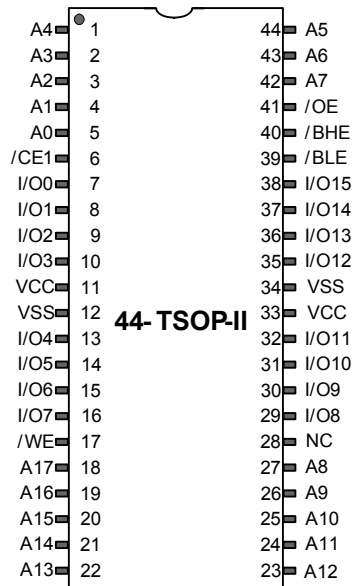

**Note**

- NC pins are not connected internally to the die and are typically used for address expansion to a higher-density device. Refer to the respective datasheets for pin configuration.

## Maximum Ratings

Exceeding maximum ratings may shorten the useful life of the device. User guidelines are not tested.

Storage temperature .....	-65 °C to + 150 °C
Ambient temperature with power applied .....	-55 °C to + 125 °C
Supply voltage to ground potential <sup>[4]</sup> .....	-0.3 V to V <sub>CC</sub> + 0.3 V
DC voltage applied to outputs in HI-Z state <sup>[4]</sup> .....	-0.3 V to V <sub>CC</sub> + 0.3 V

DC input voltage <sup>[4]</sup> .....	-0.3 V to V <sub>CC</sub> + 0.3 V
Output current into outputs (in low state) .....	20 mA
Static discharge voltage (MIL-STD-883, Method 3015) .....	>2001 V
Latch-up current .....	>140 mA

## Operating Range

Grade	Ambient Temperature	V <sub>CC</sub>
Automotive-A	-40 °C to +85 °C	2.2 V to 3.6 V
		4.5 V to 5.5 V

## DC Electrical Characteristics

Over the operating range

Parameter	Description	Test Conditions	45 ns (Automotive-A)			Unit		
			Min	Typ	Max			
V <sub>OH</sub>	Output HIGH voltage	2.2 V to 2.7 V	V <sub>CC</sub> = Min, I <sub>OH</sub> = -0.1 mA		2	-	-	V
		2.7 V to 3.6 V	V <sub>CC</sub> = Min, I <sub>OH</sub> = -1.0 mA		2.4	-	-	
		4.5 V to 5.5 V	V <sub>CC</sub> = Min, I <sub>OH</sub> = -1.0 mA		2.4	-	-	
		4.5 V to 5.5 V	V <sub>CC</sub> = Min, I <sub>OH</sub> = -0.1 mA		V <sub>CC</sub> - 0.5 <sup>[5]</sup>	-	-	
V <sub>OL</sub>	Output LOW voltage	2.2 V to 2.7 V	V <sub>CC</sub> = Min, I <sub>OL</sub> = 0.1 mA		-	-	0.4	V
		2.7 V to 3.6 V	V <sub>CC</sub> = Min, I <sub>OL</sub> = 2.1 mA		-	-	0.4	
		4.5 V to 5.5 V	V <sub>CC</sub> = Min, I <sub>OL</sub> = 2.1 mA		-	-	0.4	
V <sub>IH</sub>	Input HIGH voltage	2.2 V to 2.7 V	-	1.8	-	V <sub>CC</sub> + 0.3 <sup>[4]</sup>	V	
		2.7 V to 3.6 V	-	2	-	V <sub>CC</sub> + 0.3 <sup>[4]</sup>		
		4.5 V to 5.5 V	-	2.2	-	V <sub>CC</sub> + 0.5 <sup>[4]</sup>		
V <sub>IL</sub>	Input LOW voltage	2.2 V to 2.7 V	-	-0.3 <sup>[4]</sup>	-	0.6	V	
		2.7 V to 3.6 V	-	-0.3 <sup>[4]</sup>	-	0.8		
		4.5 V to 5.5 V	-	-0.5 <sup>[4]</sup>	-	0.8		
I <sub>Ix</sub>	Input leakage current	GND ≤ V <sub>IN</sub> ≤ V <sub>CC</sub>		-1	-	+1	μA	
I <sub>OZ</sub>	Output leakage current	GND ≤ V <sub>OUT</sub> ≤ V <sub>CC</sub> , Output disabled		-1	-	+1	μA	
I <sub>CC</sub>	V <sub>CC</sub> operating supply current	Max V <sub>CC</sub> , I <sub>OUT</sub> = 0 mA, CMOS levels	f = f <sub>MAX</sub>	-	15	20	mA	
			f = 1 MHz	-	3.5	6		

### Note

- V<sub>IL(min)</sub> = -2.0 V and V<sub>IH(max)</sub> = V<sub>CC</sub> + 2 V for pulse durations of less than 20 ns.
- This parameter is guaranteed by design and not tested.

**DC Electrical Characteristics** (continued)

Over the operating range

Parameter	Description	Test Conditions	45 ns (Automotive-A)			Unit
			Min	Typ	Max	
$I_{SB1}^{[6]}$	Automatic power down current – CMOS inputs; $V_{CC} = 2.2\text{ V to }3.6\text{ V and }4.5\text{ V to }5.5\text{ V}$	$\overline{CE}_1 \geq V_{CC} - 0.2\text{ V or }CE_2 \leq 0.2\text{ V}$ $V_{IN} \geq V_{CC} - 0.2\text{ V or }V_{IN} \leq 0.2\text{ V,}$ $f = f_{max}$ (address and data only), $f = 0$ ( $\overline{OE}$ , $\overline{WE}$ , $\overline{BHE}$ , and $\overline{BLE}$ ), Max $V_{CC}$	–	3.5	8.7	$\mu\text{A}$
$I_{SB2}^{[6]}$	Automatic power down current – CMOS inputs $V_{CC} = 2.2\text{ V to }3.6\text{ V and }4.5\text{ V to }5.5\text{ V}$	$\overline{CE}_1 \geq V_{CC} - 0.2\text{ V or }CE_2 \leq 0.2\text{ V}$ $V_{IN} \geq V_{CC} - 0.2\text{ V or }V_{IN} \leq 0.2\text{ V,}$ $f = 0, \text{ Max }V_{CC}$	–	3.5	8.7	$\mu\text{A}$

**Notes**

 6. Chip enable ( $\overline{CE}$ ) must be tied to CMOS levels to meet the  $I_{SB1}/I_{SB2}/I_{CCDR}$  spec. Other inputs can be left floating.

## Capacitance

Parameter <sup>[7]</sup>	Description	Test Conditions	Max	Unit
$C_{IN}$	Input capacitance	$T_A = 25\text{ }^\circ\text{C}$ , $f = 1\text{ MHz}$ , $V_{CC} = V_{CC(\text{typ})}$	10	pF
$C_{OUT}$	Output capacitance		10	pF

## Thermal Resistance

Parameter <sup>[7]</sup>	Description	Test Conditions	44-pin TSOP II	Unit
$\Theta_{JA}$	Thermal resistance (junction to ambient)	Still air, soldered on a 3 × 4.5 inch, four-layer printed circuit board	66.82	$^\circ\text{C/W}$
$\Theta_{JC}$	Thermal resistance (junction to case)		15.97	$^\circ\text{C/W}$

## AC Test Loads and Waveforms

Figure 2. AC Test Loads and Waveforms<sup>[8]</sup>

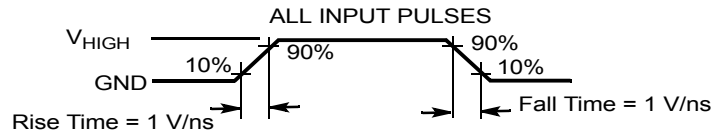
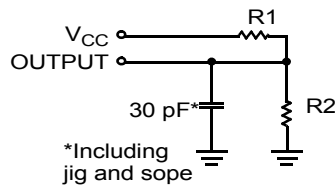

Equivalent to: THÉVENIN EQUIVALENT

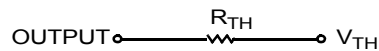

Parameters	2.5 V	3.0 V	Unit
R1	16667	1103	$\Omega$
R2	15385	1554	$\Omega$
$R_{TH}$	8000	645	$\Omega$
$V_{TH}$	1.20	1.75	V

### Notes

7. Tested initially and after any design or process changes that may affect these parameters.
8. Full-device operation requires linear  $V_{CC}$  ramp from  $V_{DR}$  to  $V_{CC(\text{min})} \geq 100\text{ }\mu\text{s}$  or stable at  $V_{CC(\text{min})} \geq 100\text{ }\mu\text{s}$ .

## Data Retention Characteristics

Over the Operating range

Parameter	Description	Conditions (Automotive-A)	Min	Typ <sup>[9]</sup>	Max	Unit
$V_{DR}$	$V_{CC}$ for data retention	–	1	–	–	V
$I_{CCDR}$ <sup>[10, 11]</sup>	Data retention current	$V_{CC} = 1.2\text{ V}$ $\overline{CE}_1 \geq V_{CC} - 0.2\text{ V}$ or $CE_2 \leq 0.2\text{ V}$ , $V_{IN} \geq V_{CC} - 0.2\text{ V}$ or $V_{IN} \leq 0.2\text{ V}$	–	–	13	$\mu\text{A}$
$t_{CDR}$ <sup>[12]</sup>	Chip deselect to data retention time	–	0	–	–	ns
$t_R$ <sup>[12, 13]</sup>	Operation recovery time	–	45	–	–	ns

## Data Retention Waveform

Figure 3. Data Retention Waveform

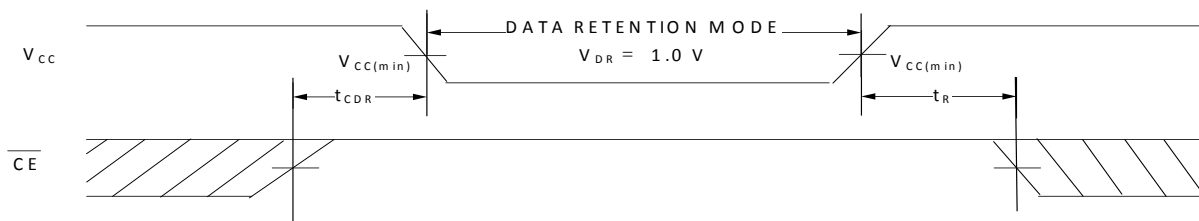

### Notes

9. Typical values are included for reference only and are not guaranteed or tested. Typical values are measured at  $V_{CC} = 3\text{ V}$  (for  $V_{CC}$  range of 2.2 V–3.6 V) and  $V_{CC} = 5\text{ V}$  (for  $V_{CC}$  range of 4.5 V–5.5 V),  $T_A = 25^\circ\text{C}$ .
10. Chip enable ( $\overline{CE}$ ) must be tied to CMOS levels to meet the  $I_{SB1} / I_{SB2} / I_{CCDR}$  spec. Other inputs can be left floating.
11.  $I_{CCDR}$  is guaranteed only after device is first powered up to  $V_{CC(\text{min})}$  and then brought down to  $V_{DR}$ .
12. These parameters are guaranteed by design.
13. Full-device operation requires linear  $V_{CC}$  ramp from  $V_{DR}$  to  $V_{CC(\text{min})} \geq 100\ \mu\text{s}$  or stable at  $V_{CC(\text{min})} \geq 100\ \mu\text{s}$ .



## AC Switching Characteristics

Parameter <sup>[14]</sup>	Description	45 ns		Unit
		Min	Max	
<b>Read Cycle</b>				
$t_{RC}$	Read cycle time	45	–	ns
$t_{AA}$	Address to data valid	–	45	ns
$t_{OHA}$	Data hold from address change	10	–	ns
$t_{ACE}$	$\overline{CE}_1$ LOW and $CE_2$ HIGH to data valid	–	45	ns
$t_{DOE}$	$\overline{OE}$ LOW to data valid	–	22	ns
$t_{LZOE}$	$\overline{OE}$ LOW to Low impedance <sup>[15, 16]</sup>	5	–	ns
$t_{HZOE}$	$\overline{OE}$ HIGH to HI-Z <sup>[15, 16, 17]</sup>	–	18	ns
$t_{LZCE}$	$\overline{CE}_1$ LOW and $CE_2$ HIGH to Low impedance <sup>[15, 16]</sup>	10	–	ns
$t_{HZCE}$	$\overline{CE}_1$ HIGH and $CE_2$ LOW to HI-Z <sup>[15, 16, 17]</sup>	–	18	ns
$t_{PU}$	$\overline{CE}_1$ LOW and $CE_2$ HIGH to power-up <sup>[16]</sup>	0	–	ns
$t_{PD}$	$\overline{CE}_1$ HIGH and $CE_2$ LOW to power-down <sup>[16]</sup>	–	45	ns
$t_{DBE}$	$\overline{BLE} / \overline{BHE}$ LOW to data valid	–	22	ns
$t_{LZBE}$	$\overline{BLE} / \overline{BHE}$ LOW to Low impedance <sup>[15, 16]</sup>	5	–	ns
$t_{HZBE}$	$\overline{BLE} / \overline{BHE}$ HIGH to HI-Z <sup>[15, 16, 17]</sup>	–	18	ns
<b>Write Cycle</b> <sup>[18, 19]</sup>				
$t_{WC}$	Write cycle time	45	–	ns
$t_{SCE}$	$\overline{CE}_1$ LOW and $CE_2$ HIGH to write end	35	–	ns
$t_{AW}$	Address setup to write end	35	–	ns
$t_{HA}$	Address hold from write end	0	–	ns
$t_{SA}$	Address setup to write start	0	–	ns
$t_{PWE}$	$\overline{WE}$ pulse width	35	–	ns
$t_{BW}$	$\overline{BLE} / \overline{BHE}$ LOW to write end	35	–	ns
$t_{SD}$	Data setup to write end	25	–	ns
$t_{HD}$	Data hold from write end	0	–	ns
$t_{HZWE}$	$\overline{WE}$ LOW to HI-Z <sup>[15, 16, 17]</sup>	–	18	ns
$t_{LZWE}$	$\overline{WE}$ HIGH to Low impedance <sup>[15, 16]</sup>	10	–	ns

### Notes

14. Test conditions assume a signal transition time (rise/fall) of 3 ns or less, timing reference levels of 1.5 V (for  $V_{CC} \geq 3$  V) and  $V_{CC}/2$  (for  $V_{CC} < 3$  V), and input pulse levels of 0 to 3 V (for  $V_{CC} \geq 3$  V) and 0 to  $V_{CC}$  (for  $V_{CC} < 3$  V). Test conditions for the read cycle use output loading shown in AC Test Loads and Waveforms section, unless specified otherwise.

15. At any temperature and voltage condition,  $t_{HZCE}$  is less than  $t_{LZCE}$ ,  $t_{HZBE}$  is less than  $t_{LZBE}$ ,  $t_{HZOE}$  is less than  $t_{LZOE}$ , and  $t_{HZWE}$  is less than  $t_{LZWE}$  for any device.

16. These parameters are guaranteed by design.

17.  $t_{HZOE}$ ,  $t_{HZCE}$ ,  $t_{HZBE}$ , and  $t_{HZWE}$  transitions are measured when the outputs enter a high-impedance state.

18. The internal write time of the memory is defined by the overlap of  $\overline{WE} = V_{IL}$ ,  $\overline{CE}_1 = V_{IL}$ , and  $CE_2 = V_{IH}$ . All signals must be ACTIVE to initiate a write and any of these signals can terminate a write by going INACTIVE. The data input setup and hold timing must refer to the edge of the signal that terminates the write.

19. The minimum pulse width in Write Cycle No. 3 ( $\overline{WE}$  Controlled,  $\overline{OE}$  LOW) should be equal to sum of  $t_{SD}$  and  $t_{HZWE}$ .

## Switching Waveforms

Figure 4. Read Cycle No. 1 of CY62146G (Address Transition Controlled) [20]

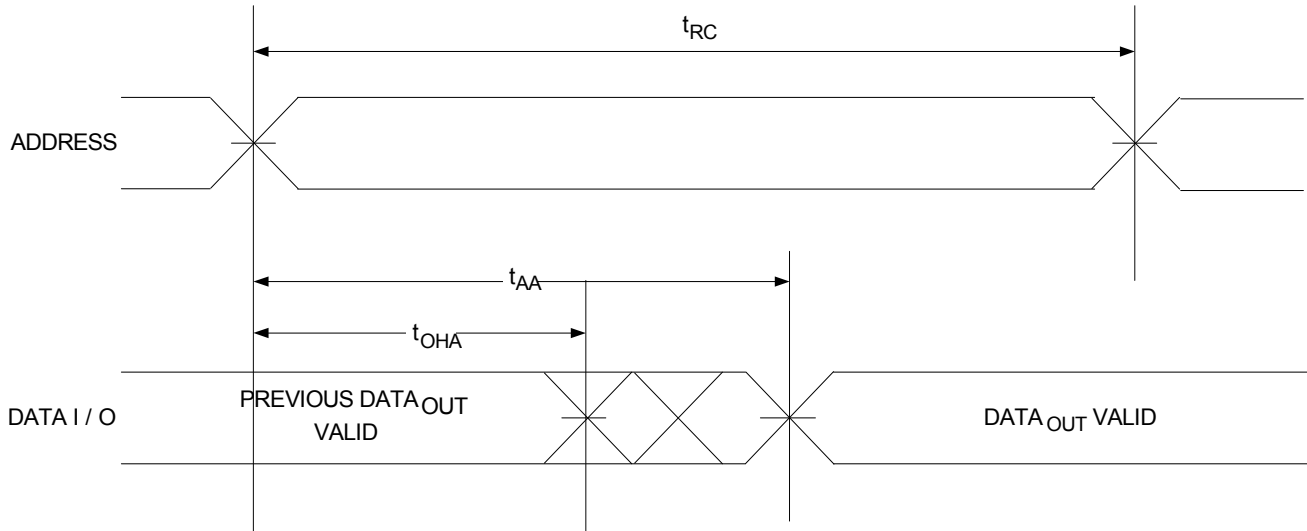
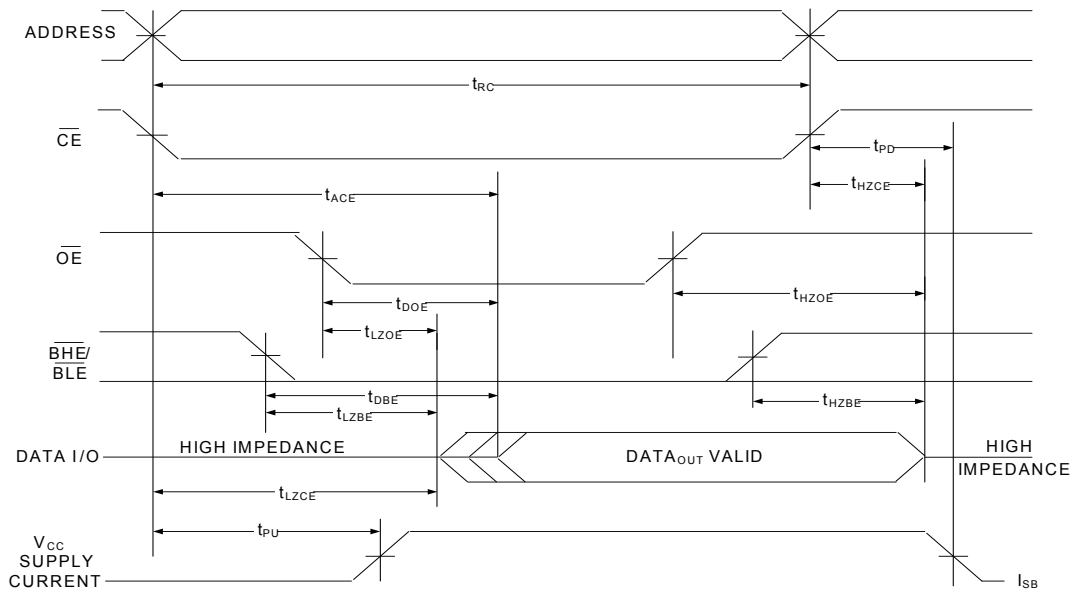

Figure 5. Read Cycle No. 2 ( $\overline{OE}$  Controlled) [21, 22]



### Notes

20. The device is continuously selected.  $\overline{OE} = V_{IL}$ ,  $\overline{CE} = V_{IL}$ ,  $\overline{BHE}$  or  $\overline{BLE}$  or both =  $V_{IL}$ .
21.  $\overline{WE}$  is HIGH for Read cycle.
22. Address valid prior to or coincident with  $\overline{CE}$  LOW transition.

Switching Waveforms (continued)

Figure 6. Write Cycle No. 1 ( $\overline{\text{WE}}$  Controlled) [23, 24]

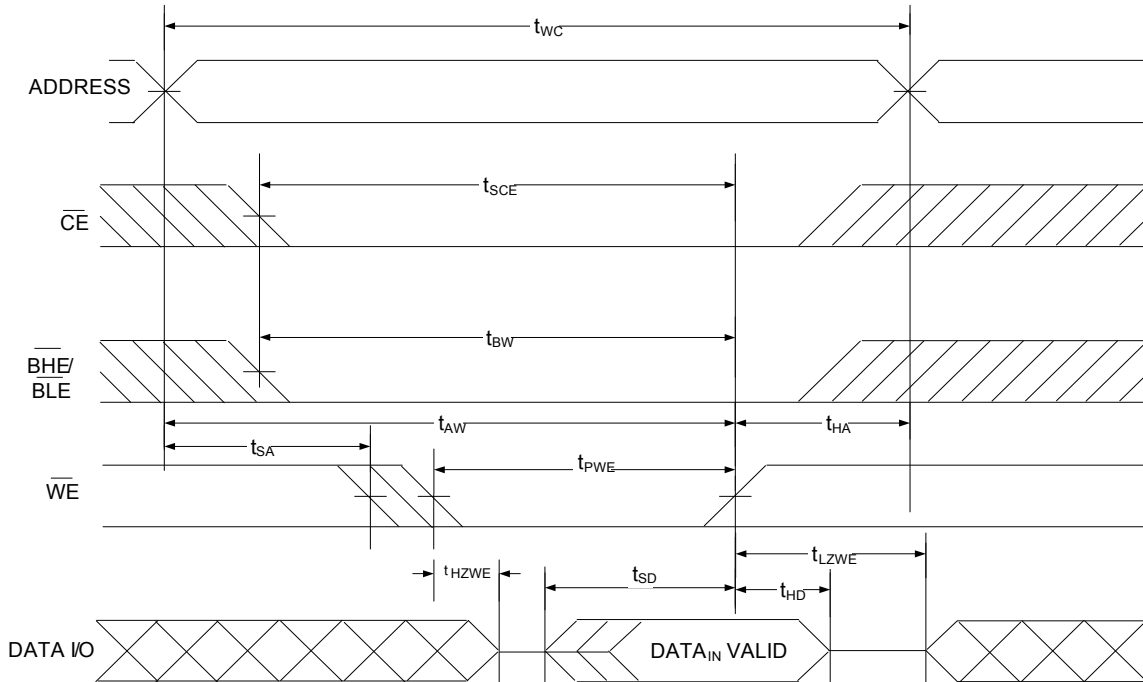

Notes

23. The internal write time of the memory is defined by the overlap of  $\overline{\text{WE}} = V_{\text{IL}}$ ,  $\overline{\text{CE}}_1 = V_{\text{IL}}$ ,  $\overline{\text{BHE}}$  or  $\overline{\text{BLE}}$  or both =  $V_{\text{IL}}$ , and  $\text{CE}_2 = V_{\text{IH}}$ . All signals must be ACTIVE to initiate a write and any of these signals can terminate a write by going INACTIVE. The data input setup and hold timing must refer to the edge of the signal that terminates the write.

24. Data I/O is in a HI-Z state if  $\overline{\text{CE}} = V_{\text{IH}}$ , or  $\overline{\text{OE}} = V_{\text{IH}}$  or  $\overline{\text{BHE}}$ , and/or  $\overline{\text{BLE}} = V_{\text{IH}}$ .

Switching Waveforms (continued)

Figure 7. Write Cycle No. 2 ( $\overline{\text{CE}}$  Controlled) [25, 26]

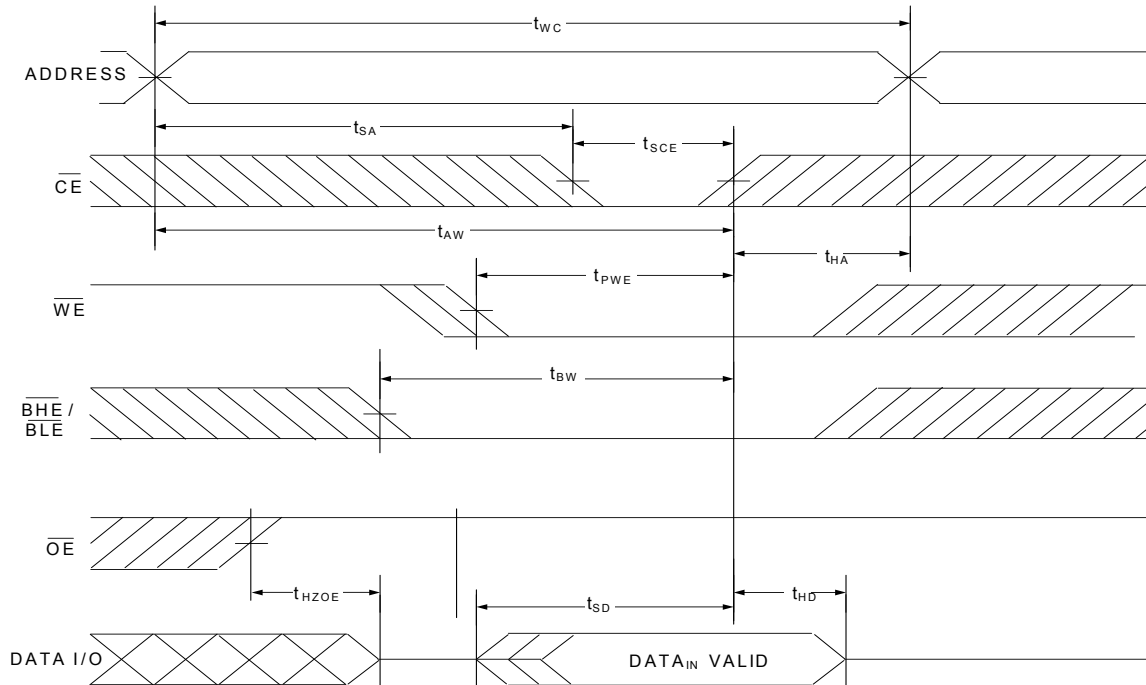
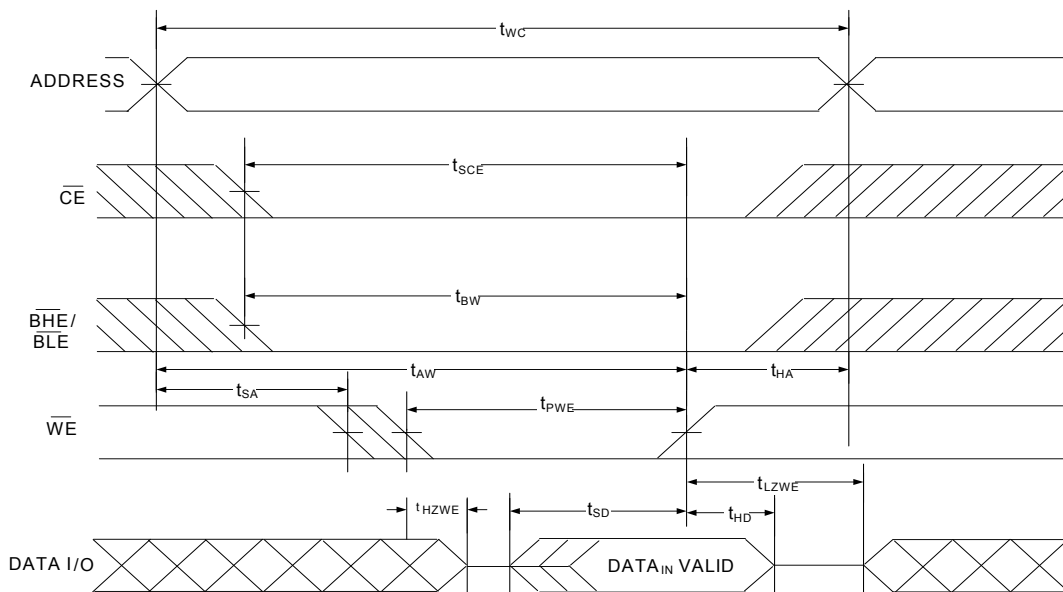

Figure 8. Write Cycle No. 3 ( $\overline{\text{WE}}$  Controlled,  $\overline{\text{OE}}$  LOW) [25, 26, 27]



Notes

25. The internal write time of the memory is defined by the overlap of  $\overline{\text{WE}} = V_{\text{IL}}$ ,  $\overline{\text{CE}}_1 = V_{\text{IL}}$ ,  $\overline{\text{BHE}}$  or  $\overline{\text{BLE}}$  or both =  $V_{\text{IL}}$ , and  $\text{CE}_2 = V_{\text{IH}}$ . All signals must be ACTIVE to initiate a write and any of these signals can terminate a write by going INACTIVE. The data input setup and hold timing must refer to the edge of the signal that terminates the write.

26. Data I/O is in HI-Z state if  $\overline{\text{CE}} = V_{\text{IH}}$ , or  $\overline{\text{OE}} = V_{\text{IH}}$  or  $\overline{\text{BHE}}$ , and/or  $\overline{\text{BLE}} = V_{\text{IH}}$ .

27. The minimum write pulse width for Write Cycle No. 3 ( $\overline{\text{WE}}$  Controlled,  $\overline{\text{OE}}$  LOW) should be sum of  $t_{\text{HZWE}}$  and  $t_{\text{SD}}$ .

Switching Waveforms (continued)

Figure 9. Write Cycle No. 4 ( $\overline{\text{BHE}}/\overline{\text{BLE}}$  Controlled) [28, 29]

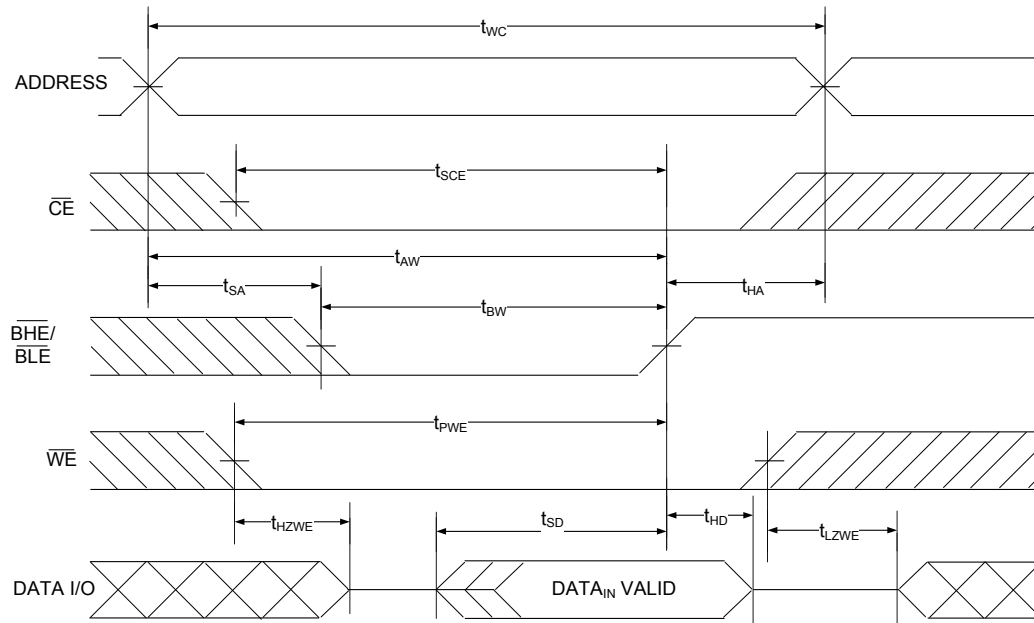

Notes

28. The internal write time of the memory is defined by the overlap of  $\overline{\text{WE}} = V_{\text{IL}}$ ,  $\overline{\text{CE}}_1 = V_{\text{IL}}$ ,  $\overline{\text{BHE}}$  or  $\overline{\text{BLE}}$  or both =  $V_{\text{IL}}$ , and  $\text{CE}_2 = V_{\text{IH}}$ . All signals must be ACTIVE to initiate a write and any of these signals can terminate a write by going INACTIVE. The data input setup and hold timing must refer to the edge of the signal that terminates the write.

29. Data I/O is in a HI-Z state if  $\overline{\text{CE}} = V_{\text{IH}}$ , or  $\overline{\text{OE}} = V_{\text{IH}}$  or  $\overline{\text{BHE}}$ , and/or  $\overline{\text{BLE}} = V_{\text{IH}}$ .

**Truth Table – CY62146G**

$\overline{\text{CE}}$	$\overline{\text{WE}}$	$\overline{\text{OE}}$	$\overline{\text{BHE}}$	$\overline{\text{BLE}}$	Inputs/Outputs	Mode	Power
H	X	X	X	X	HI-Z	Deselect/Power-down	Standby ( $I_{\text{SB}}$ )
X <sup>[30]</sup>	X	X	H	H	HI-Z	Output disabled	Active ( $I_{\text{CC}}$ )
L	H	L	L	L	Data Out ( $I/O_0$ – $I/O_{15}$ )	Read	Active ( $I_{\text{CC}}$ )
L	H	L	H	L	Data Out ( $I/O_0$ – $I/O_7$ ); HI-Z ( $I/O_8$ – $I/O_{15}$ )	Read	Active ( $I_{\text{CC}}$ )
L	H	L	L	H	HI-Z ( $I/O_0$ – $I/O_7$ ); Data Out ( $I/O_8$ – $I/O_{15}$ )	Read	Active ( $I_{\text{CC}}$ )
L	H	H	X	X	HI-Z	Output disabled	Active ( $I_{\text{CC}}$ )
L	L	X	L	L	Data In ( $I/O_0$ – $I/O_{15}$ )	Write	Active ( $I_{\text{CC}}$ )
L	L	X	H	L	Data In ( $I/O_0$ – $I/O_7$ ); HI-Z ( $I/O_8$ – $I/O_{15}$ )	Write	Active ( $I_{\text{CC}}$ )
L	L	X	L	H	HI-Z ( $I/O_0$ – $I/O_7$ ); Data In ( $I/O_8$ – $I/O_{15}$ )	Write	Active ( $I_{\text{CC}}$ )

**Notes**

30. The 'X' (Don't care) state for the chip enables refer to the logic state (either HIGH or LOW). Intermediate voltage levels on these pins is not permitted.

### Ordering Information

Speed (ns)	Voltage Range	Ordering Code	Package Diagram	Package Type	Operating Range
45	2.2 V–3.6 V	CY62146G30-45ZSXA	51-85087	44-pin TSOP II	Automotive-A
		CY62146G30-45ZSXAT	51-85087	44-pin TSOP II, Tape & Reel	
4.5 V–5.5 V	4.5 V–5.5 V	CY62146G-45ZSXA	51-85087	44-pin TSOP II	
		CY62146G-45ZSXAT	51-85087	44-pin TSOP II, Tape & Reel	

### Ordering Code Definitions

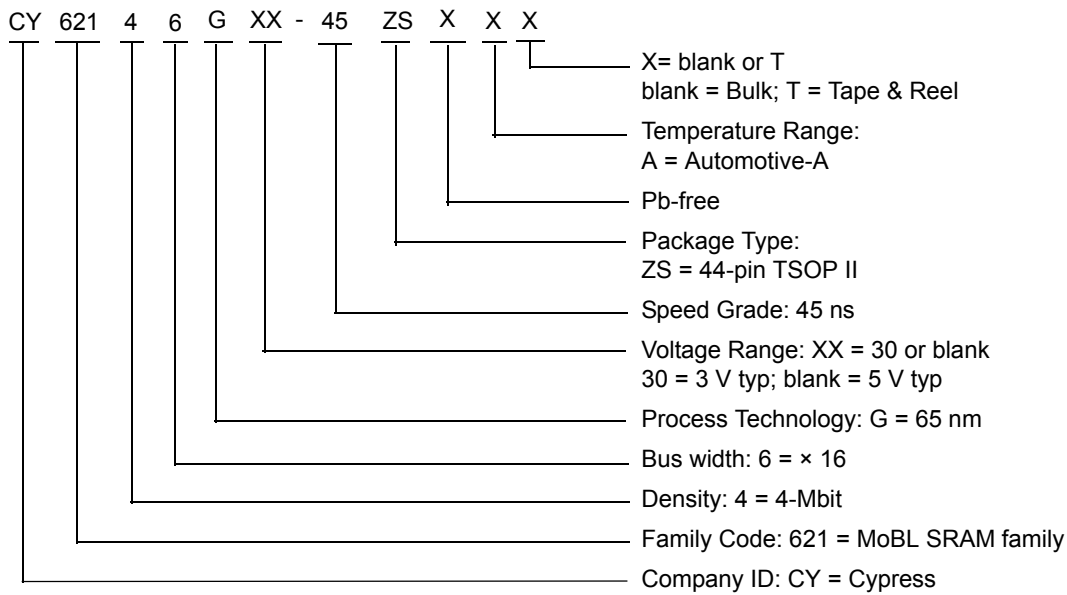

Package Diagrams

Figure 10. 44-pin TSOP Z44-II Package Outline, 51-85087

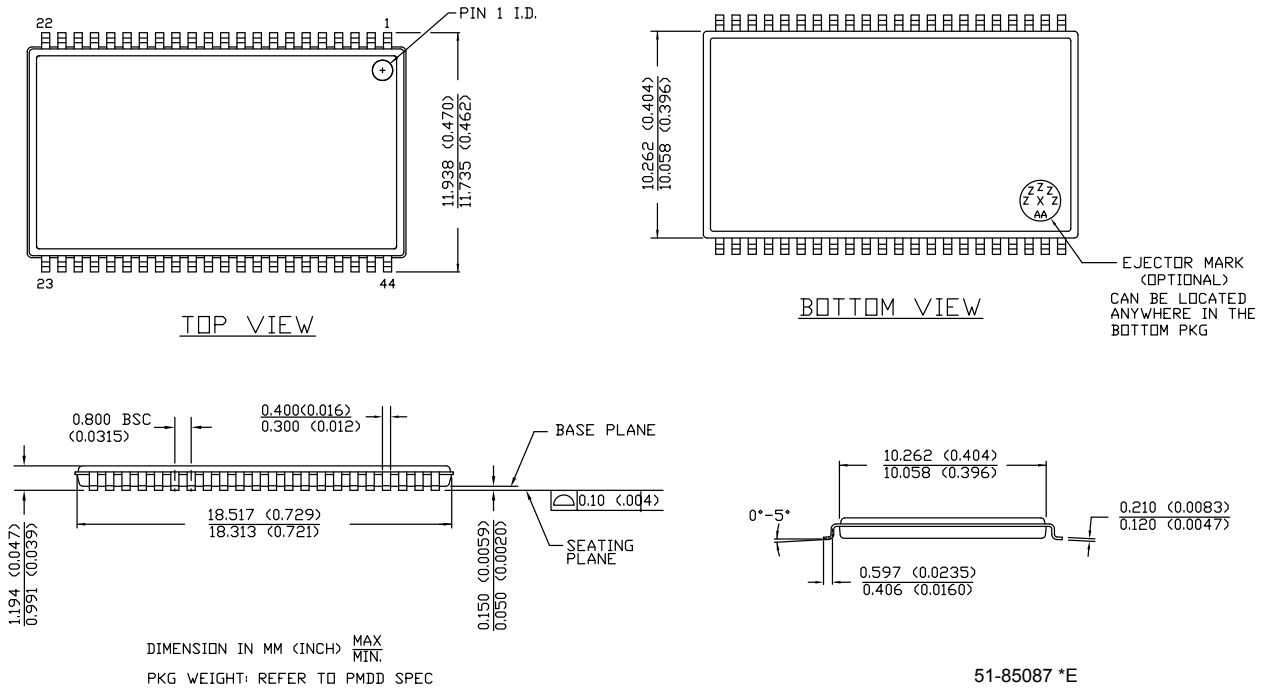



## Acronyms

Acronym	Description
$\overline{\text{BHE}}$	Byte High Enable
$\overline{\text{BLE}}$	Byte Low Enable
$\overline{\text{CE}}$	Chip Enable
CMOS	Complementary Metal Oxide Semiconductor
I/O	Input/Output
$\overline{\text{OE}}$	Output Enable
SRAM	Static Random Access Memory
TSOP	Thin Small Outline Package
VFBGA	Very Fine-Pitch Ball Grid Array
$\overline{\text{WE}}$	Write Enable

## Document Conventions

### Units of Measure

Symbol	Unit of Measure
°C	degree Celsius
MHz	megahertz
μA	microampere
μs	microsecond
mA	milliampere
mm	millimeter
ns	nanosecond
Ω	ohm
%	percent
pF	picofarad
V	volt
W	watt

**Document History Page**

Document Title: CY62146G MoBL® Automotive, 4-Mbit (256K words × 16 bit) Static RAM with Error-Correcting Code (ECC) Document Number: 002-03594				
Rev.	ECN No.	Orig. of Change	Submission Date	Description of Change
*A	5035945	NILE	12/09/2015	Changed status from Preliminary to Final.
*B	5427239	NILE	09/23/2016	Updated <a href="#">Features</a> : Added "AEC-Q100 qualified". Updated <a href="#">Maximum Ratings</a> : Updated Note 4 (Replaced "2 ns" with "20 ns"). Updated <a href="#">DC Electrical Characteristics</a> : Changed minimum value of $V_{OH}$ parameter from 2.2 V to 2.4 V corresponding to Operating Range "2.7 V to 3.6 V" and Test Condition " $V_{CC} = \text{Min}, I_{OH} = -1.0 \text{ mA}$ ". Changed minimum value of $V_{IH}$ parameter from 2.0 V to 1.8 V corresponding to Operating Range "2.2 V to 2.7 V". Updated <a href="#">Ordering Information</a> : Updated part numbers. Updated to new template. Completing Sunset Review.
*C	5975694	AESATMP8	11/24/2017	Updated logo and Copyright.

## Sales, Solutions, and Legal Information

### Worldwide Sales and Design Support

Cypress maintains a worldwide network of offices, solution centers, manufacturer's representatives, and distributors. To find the office closest to you, visit us at [Cypress Locations](#).

#### Products

ARM <sup>®</sup> Cortex <sup>®</sup> Microcontrollers	<a href="http://cypress.com/arm">cypress.com/arm</a>
Automotive	<a href="http://cypress.com/automotive">cypress.com/automotive</a>
Clocks & Buffers	<a href="http://cypress.com/clocks">cypress.com/clocks</a>
Interface	<a href="http://cypress.com/interface">cypress.com/interface</a>
Internet of Things	<a href="http://cypress.com/iot">cypress.com/iot</a>
Memory	<a href="http://cypress.com/memory">cypress.com/memory</a>
Microcontrollers	<a href="http://cypress.com/mcu">cypress.com/mcu</a>
PSoC	<a href="http://cypress.com/psoc">cypress.com/psoc</a>
Power Management ICs	<a href="http://cypress.com/pmic">cypress.com/pmic</a>
Touch Sensing	<a href="http://cypress.com/touch">cypress.com/touch</a>
USB Controllers	<a href="http://cypress.com/usb">cypress.com/usb</a>
Wireless Connectivity	<a href="http://cypress.com/wireless">cypress.com/wireless</a>

#### PSoC<sup>®</sup> Solutions

[PSoC 1](#) | [PSoC 3](#) | [PSoC 4](#) | [PSoC 5LP](#) | [PSoC 6](#)

#### Cypress Developer Community

[Forums](#) | [WICED IOT Forums](#) | [Projects](#) | [Video](#) | [Blogs](#) | [Training](#) | [Components](#)

#### Technical Support

[cypress.com/support](http://cypress.com/support)

---

© Cypress Semiconductor Corporation, 2015-2017. This document is the property of Cypress Semiconductor Corporation and its subsidiaries, including Spansion LLC ("Cypress"). This document, including any software or firmware included or referenced in this document ("Software"), is owned by Cypress under the intellectual property laws and treaties of the United States and other countries worldwide. Cypress reserves all rights under such laws and treaties and does not, except as specifically stated in this paragraph, grant any license under its patents, copyrights, trademarks, or other intellectual property rights. If the Software is not accompanied by a license agreement and you do not otherwise have a written agreement with Cypress governing the use of the Software, then Cypress hereby grants you a personal, non-exclusive, nontransferable license (without the right to sublicense) (1) under its copyright rights in the Software (a) for Software provided in source code form, to modify and reproduce the Software solely for use with Cypress hardware products, only internally within your organization, and (b) to distribute the Software in binary code form externally to end users (either directly or indirectly through resellers and distributors), solely for use on Cypress hardware product units, and (2) under those claims of Cypress's patents that are infringed by the Software (as provided by Cypress, unmodified) to make, use, distribute, and import the Software solely for use with Cypress hardware products. Any other use, reproduction, modification, translation, or compilation of the Software is prohibited.

TO THE EXTENT PERMITTED BY APPLICABLE LAW, CYPRESS MAKES NO WARRANTY OF ANY KIND, EXPRESS OR IMPLIED, WITH REGARD TO THIS DOCUMENT OR ANY SOFTWARE OR ACCOMPANYING HARDWARE, INCLUDING, BUT NOT LIMITED TO, THE IMPLIED WARRANTIES OF MERCHANTABILITY AND FITNESS FOR A PARTICULAR PURPOSE. To the extent permitted by applicable law, Cypress reserves the right to make changes to this document without further notice. Cypress does not assume any liability arising out of the application or use of any product or circuit described in this document. Any information provided in this document, including any sample design information or programming code, is provided only for reference purposes. It is the responsibility of the user of this document to properly design, program, and test the functionality and safety of any application made of this information and any resulting product. Cypress products are not designed, intended, or authorized for use as critical components in systems designed or intended for the operation of weapons, weapons systems, nuclear installations, life-support devices or systems, other medical devices or systems (including resuscitation equipment and surgical implants), pollution control or hazardous substances management, or other uses where the failure of the device or system could cause personal injury, death, or property damage ("Unintended Uses"). A critical component is any component of a device or system whose failure to perform can be reasonably expected to cause the failure of the device or system, or to affect its safety or effectiveness. Cypress is not liable, in whole or in part, and you shall and hereby do release Cypress from any claim, damage, or other liability arising from or related to all Unintended Uses of Cypress products. You shall indemnify and hold Cypress harmless from and against all claims, costs, damages, and other liabilities, including claims for personal injury or death, arising from or related to any Unintended Uses of Cypress products.

Cypress, the Cypress logo, Spansion, the Spansion logo, and combinations thereof, WICED, PSoC, CapSense, EZ-USB, F-RAM, and Traveo are trademarks or registered trademarks of Cypress in the United States and other countries. For a more complete list of Cypress trademarks, visit [cypress.com](http://cypress.com). Other names and brands may be claimed as property of their respective owners.