



Standard Avalanche SMD Rectifier



DO-214AC (SMA)

FEATURES

- Low profile package
- Ideal for automated placement
- Controlled avalanche characteristics
- Glass passivated pellet chip junction
- Low reverse current
- High surge current capability
- Meets MSL level 1, per J-STD-020, LF maximum peak of 260 °C
- AEC-Q101 qualified
- Material categorization: for definitions of compliance please see www.vishay.com/doc?99912



RoHS
COMPLIANT
HALOGEN
FREE

TYPICAL APPLICATIONS

For use in general purpose rectification of power supplies, inverters, converters, and freewheeling diodes for consumer, automotive, and telecommunication.

PRIMARY CHARACTERISTICS	
$I_{F(AV)}$	1.5 A
V_{RRM}	200 V, 400 V, 600 V, 800 V, 1000 V, 1600 V
I_{FSM}	30 A
I_R	1.0 μ A
V_F	1.15 V
E_R	20 mJ
T_J max.	150 °C
Package	DO-214AC (SMA)
Diode variations	Single die

MECHANICAL DATA

Case: DO-214AC (SMA)

Molding compound meets UL 94 V-0 flammability rating
Base P/N-M3 - halogen-free, RoHS-compliant, and commercial grade

Base P/NHM3 - halogen-free, RoHS-compliant, and AEC-Q101 qualified

Terminals: Matte tin plated leads, solderable per J-STD-002 and JESD 22-B102

M3 suffix meets JESD 201 class 1A whisker test, HM3 suffix meets JESD 201 class 2 whisker test

Note

- BYG10Y for commercial grade only

Polarity: Color band denotes the cathode end

MAXIMUM RATINGS ($T_A = 25\text{ °C}$ unless otherwise noted)								
PARAMETER	SYMBOL	BYG10D	BYG10G	BYG10J	BYG10K	BYG10M	BYG10Y	UNIT
Device marking code		BYG10D	BYG10G	BYG10J	BYG10K	BYG10M	BYG10Y	
Maximum repetitive peak reverse voltage	V_{RRM}	200	400	600	800	1000	1600	V
Average forward current	$I_{F(AV)}$	1.5						A
Peak forward surge current 10 ms single half sine-wave superimposed on rated load	I_{FSM}	30						A
Pulse energy in avalanche mode, non repetitive (inductive load switch off) $I_{(BR)R} = 1\text{ A}$, $T_J = 25\text{ °C}$ (for BYG10D thru BYG10M) $I_{(BR)R} = 0.4\text{ A}$, $T_J = 25\text{ °C}$ (for BYG10Y)	E_R	20						mJ
Operating junction and storage temperature range	T_J, T_{STG}	-55 to +150						°C



ELECTRICAL CHARACTERISTICS ($T_A = 25\text{ }^\circ\text{C}$ unless otherwise noted)										
PARAMETER	TEST CONDITIONS		SYMBOL	BYG10D	BYG10G	BYG10J	BYG10K	BYG10M	BYG10Y	UNIT
Maximum instantaneous forward voltage ⁽¹⁾	$I_F = 1\text{ A}$	$T_J = 25\text{ }^\circ\text{C}$	V_F	1.1					V	
	$I_F = 1.5\text{ A}$			1.15						
Maximum DC reverse current	$V_R = V_{RRM}$	$T_J = 25\text{ }^\circ\text{C}$	I_R	1					μA	
		$T_J = 100\text{ }^\circ\text{C}$		10						
Maximum reverse recovery time	$I_F = 0.5\text{ A}, I_R = 1.0\text{ A}, I_{rr} = 0.25\text{ A}$		t_{rr}	4					μs	

Note

(1) Pulse test: 300 μs pulse width, 1 % duty cycle

THERMAL CHARACTERISTICS ($T_A = 25\text{ }^\circ\text{C}$ unless otherwise noted)									
PARAMETER	SYMBOL	BYG10D	BYG10G	BYG10J	BYG10K	BYG10M	BYG10Y	UNIT	
Typical thermal resistance, junction to lead	$R_{\theta JL}$	25					$^\circ\text{C/W}$		
Typical thermal resistance, junction to ambient	$R_{\theta JA}^{(1)}$	150					$^\circ\text{C/W}$		
	$R_{\theta JA}^{(2)}$	125							
	$R_{\theta JA}^{(3)}$	100							

Notes

- (1) Mounted on epoxy-glass hard tissue
- (2) Mounted on epoxy-glass hard tissue, 50 mm² 35 μm Cu
- (3) Mounted on Al-oxide-ceramic (Al₂O₃), 50 mm² 35 μm Cu

ORDERING INFORMATION (Example)				
PREFERRED P/N	UNIT WEIGHT (g)	PREFERRED PACKAGE CODE	BASE QUANTITY	DELIVERY MODE
BYG10D-M3/TR	0.064	TR	1800	7" diameter plastic tape and reel
BYG10D-M3/TR3	0.064	TR3	7500	13" diameter plastic tape and reel
BYG10DHM3/TR ⁽¹⁾	0.064	TR	1800	7" diameter plastic tape and reel
BYG10DHM3/TR3 ⁽¹⁾	0.064	TR3	7500	13" diameter plastic tape and reel

Note

(1) AEC-Q101 qualified

RATINGS AND CHARACTERISTICS CURVES ($T_A = 25\text{ }^\circ\text{C}$ unless otherwise noted)

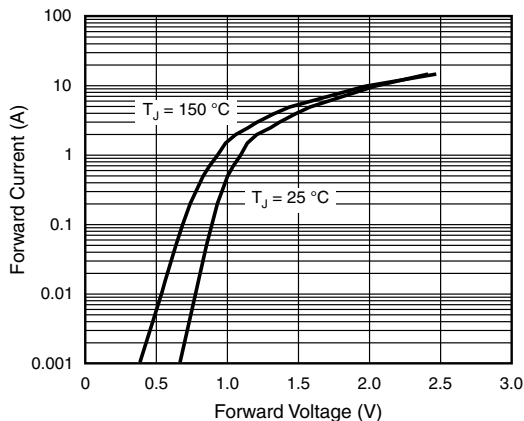

Fig. 1 - Forward Current vs. Forward Voltage

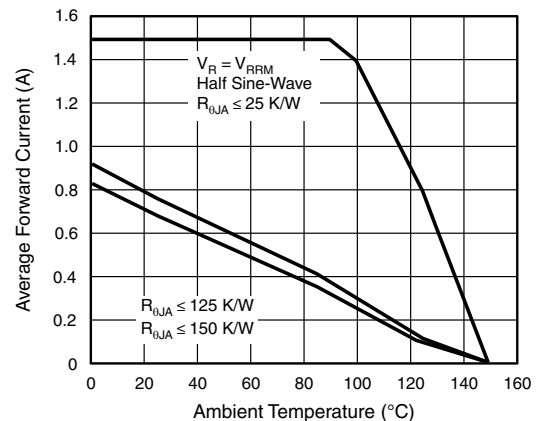

Fig. 2 - Max. Average Forward Current vs. Ambient Temperature

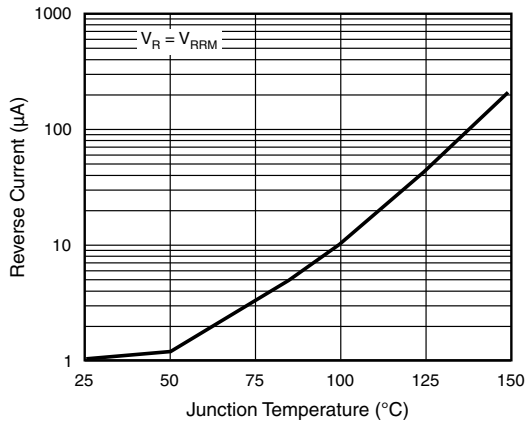

Fig. 3 - Reverse Current vs. Junction Temperature

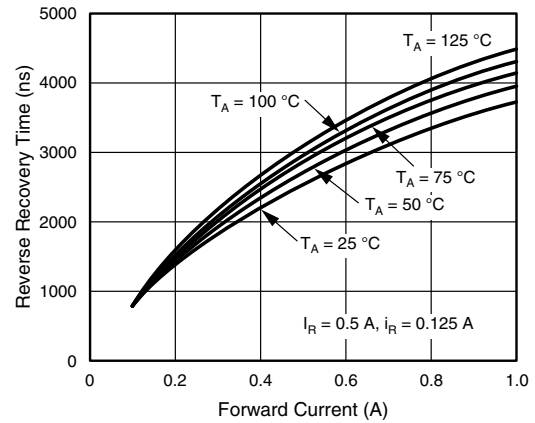

Fig. 6 - Reverse Recovery Time vs. Forward Current

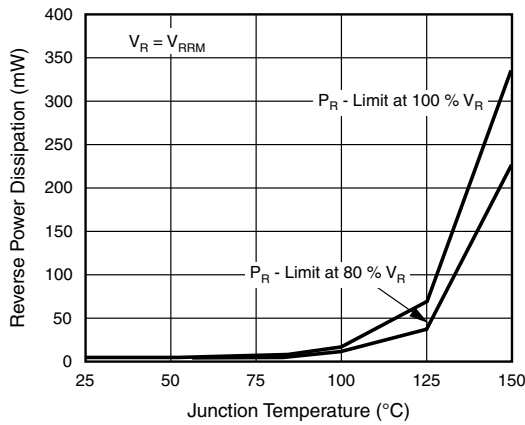

Fig. 4 - Max. Reverse Power Dissipation vs. Junction Temperature

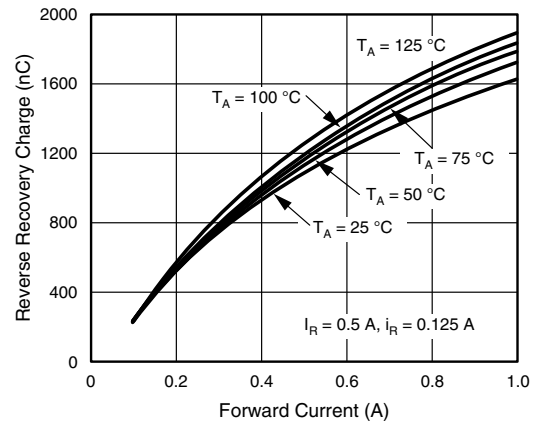

Fig. 7 - Reverse Recovery Charge vs. Forward Current

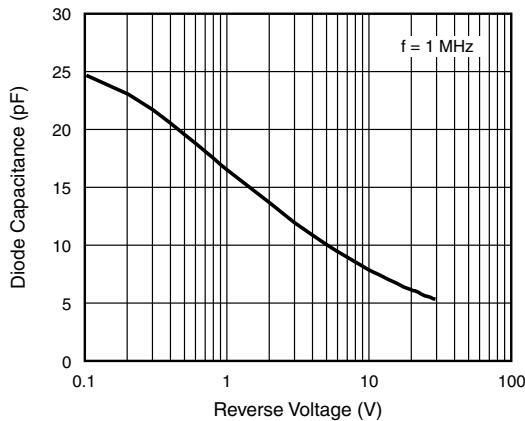
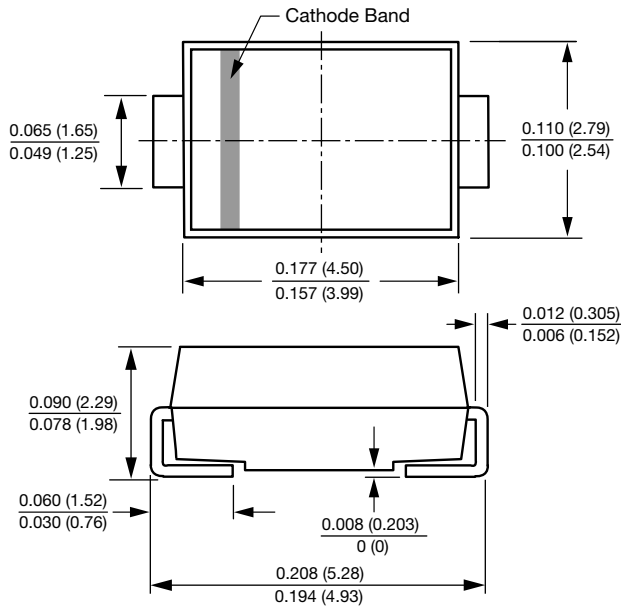

Fig. 5 - Diode Capacitance vs. Reverse Voltage



PACKAGE OUTLINE DIMENSIONS in inches (millimeters)

DO-214AC (SMA)



Mounting Pad Layout

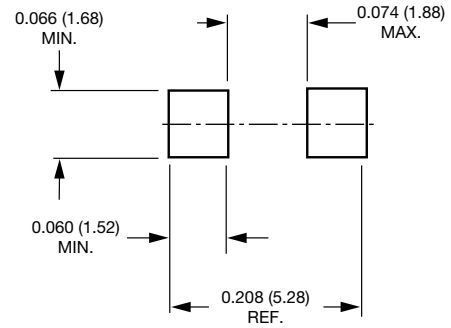



Disclaimer

ALL PRODUCT, PRODUCT SPECIFICATIONS AND DATA ARE SUBJECT TO CHANGE WITHOUT NOTICE TO IMPROVE RELIABILITY, FUNCTION OR DESIGN OR OTHERWISE.

Vishay Intertechnology, Inc., its affiliates, agents, and employees, and all persons acting on its or their behalf (collectively, "Vishay"), disclaim any and all liability for any errors, inaccuracies or incompleteness contained in any datasheet or in any other disclosure relating to any product.

Vishay makes no warranty, representation or guarantee regarding the suitability of the products for any particular purpose or the continuing production of any product. To the maximum extent permitted by applicable law, Vishay disclaims (i) any and all liability arising out of the application or use of any product, (ii) any and all liability, including without limitation special, consequential or incidental damages, and (iii) any and all implied warranties, including warranties of fitness for particular purpose, non-infringement and merchantability.

Statements regarding the suitability of products for certain types of applications are based on Vishay's knowledge of typical requirements that are often placed on Vishay products in generic applications. Such statements are not binding statements about the suitability of products for a particular application. It is the customer's responsibility to validate that a particular product with the properties described in the product specification is suitable for use in a particular application. Parameters provided in datasheets and / or specifications may vary in different applications and performance may vary over time. All operating parameters, including typical parameters, must be validated for each customer application by the customer's technical experts. Product specifications do not expand or otherwise modify Vishay's terms and conditions of purchase, including but not limited to the warranty expressed therein.

Except as expressly indicated in writing, Vishay products are not designed for use in medical, life-saving, or life-sustaining applications or for any other application in which the failure of the Vishay product could result in personal injury or death. Customers using or selling Vishay products not expressly indicated for use in such applications do so at their own risk. Please contact authorized Vishay personnel to obtain written terms and conditions regarding products designed for such applications.

No license, express or implied, by estoppel or otherwise, to any intellectual property rights is granted by this document or by any conduct of Vishay. Product names and markings noted herein may be trademarks of their respective owners.