

# DAC60096 96-Channel, 12-Bit, Low-Power, Serial-Input, High-Voltage Output DAC with Conversion Trigger

## 1 Features

- High-Channel Count
  - 96-Channel DAC
  - Specified Monotonic to 12 Bits
- Wide, Unbuffered Output Voltage Range:  $\pm 10.5$  V
- Simultaneous Update of DAC Outputs
- Clear Function
- Integrated Reference Buffers: 2.5-V Input
  - Dedicated A-B Trigger Pin
    - Toggle Mode Enables Square-Wave Generation
- SPI™-Compatible Serial Interface
  - 4-Wire Mode, 3-V to 5.5-V Operation
- Low Power: 440-mW Typical Operation
- Operating Temperature Range:  $-40^{\circ}\text{C}$  to  $+85^{\circ}\text{C}$
- 196-Ball, 15-mm x 15-mm NFBGA, 1-mm Pitch

## 2 Applications

- Optical Switches
- Optical Attenuators
- Automatic Test Equipment (ATE)
- Instrumentation

## 3 Description

The DAC60096 is a low-power, fast-settling, 96-channel, 12-bit, digital to analog converter (DAC). The device provides  $\pm 10.5$ -V unbuffered, bipolar voltage outputs. The DAC60096 high-channel count, low-power operation, and good linearity make it an ideal solution in systems where a very high number of precise analog outputs is required.

Communication to the device is performed through a high-speed, 4-wire, serial interface compatible with industry standard microprocessors and microcontrollers.

The DAC60096 can be set up to clear or update all DACs simultaneously. In addition, a versatile external conversion trigger allows each DAC channel to operate as a square-wave generator with independent amplitude control.

The DAC60096 is characterized for operation over the temperature range of  $-40^{\circ}\text{C}$  to  $+85^{\circ}\text{C}$ , and is available in a 196-ball, 15-mm x 15-mm, 1-mm pitch, BGA package.

### Device Information<sup>(1)</sup>

PART NUMBER	PACKAGE	BODY SIZE (NOM)
DAC60096	NFBGA	15.0 mm x 15.0 mm

(1) For all available packages, see the package option addendum at the end of the data sheet.

### Typical Application

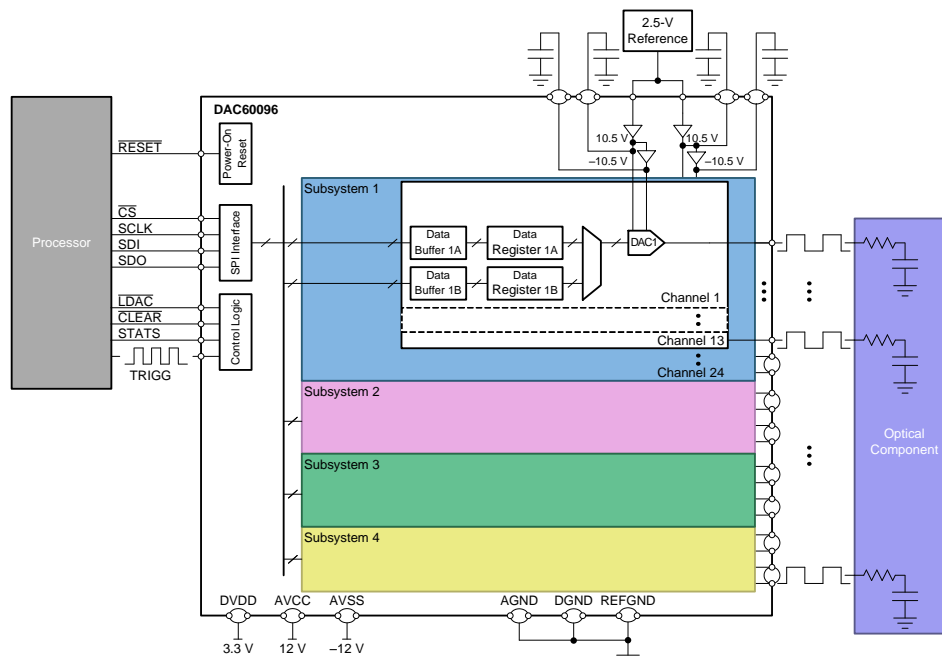

## Table of Contents

<b>1 Features</b> .....	<b>1</b>	7.3 Feature Description .....	<b>19</b>
<b>2 Applications</b> .....	<b>1</b>	7.4 Device Functional Modes .....	<b>22</b>
<b>3 Description</b> .....	<b>1</b>	7.5 Programming .....	<b>23</b>
<b>4 Revision History</b> .....	<b>2</b>	7.6 Register Maps .....	<b>25</b>
<b>5 Pin Configuration and Functions</b> .....	<b>3</b>	<b>8 Application and Implementation</b> .....	<b>31</b>
<b>6 Specifications</b> .....	<b>6</b>	8.1 Application Information .....	<b>31</b>
6.1 Absolute Maximum Ratings .....	<b>6</b>	8.2 Typical Application .....	<b>32</b>
6.2 ESD Ratings .....	<b>6</b>	<b>9 Power Supply Recommendations</b> .....	<b>36</b>
6.3 Recommended Operating Conditions .....	<b>6</b>	9.1 Device Reset Options .....	<b>36</b>
6.4 Thermal Information .....	<b>7</b>	<b>10 Layout</b> .....	<b>38</b>
6.5 Electrical Characteristics: DAC DC .....	<b>7</b>	10.1 Layout Guidelines .....	<b>38</b>
6.6 Electrical Characteristics: Square-Wave Output .....	<b>8</b>	10.2 Layout Examples .....	<b>38</b>
6.7 Electrical Characteristics: General .....	<b>9</b>	<b>11 Device and Documentation Support</b> .....	<b>45</b>
6.8 Timing Requirements .....	<b>10</b>	11.1 Documentation Support .....	<b>45</b>
6.9 Typical Characteristics: DC Mode .....	<b>12</b>	11.2 Community Resources .....	<b>45</b>
6.10 Typical Characteristics: Toggle Mode .....	<b>14</b>	11.3 Trademarks .....	<b>45</b>
6.11 Typical Characteristics, General .....	<b>15</b>	11.4 Electrostatic Discharge Caution .....	<b>45</b>
<b>7 Detailed Description</b> .....	<b>18</b>	11.5 Glossary .....	<b>45</b>
7.1 Overview .....	<b>18</b>	<b>12 Mechanical, Packaging, and Orderable Information</b> .....	<b>45</b>
7.2 Functional Block Diagram .....	<b>18</b>		

## 4 Revision History

Changes from Original (December 2015) to Revision A	Page
• Changed from product preview to production data .....	<b>1</b>

## 5 Pin Configuration and Functions

**ZEB Package  
196-Ball NFBGA  
Top View**

	A	B	C	D	E	F	G	H	J	K	L	M	N	P
14	DAC14 G4	AVSS G4	VREFL G4	VREFH G4	AVCC G4	DNC	REF2	REF GND2	DNC	AVCC G5	VREFH G5	VREFL G5	AVSS G5	DAC13 G5
13	DAC15 G4	DAC17 G4	DAC20 G4	DAC21 G4	DAC22 G4	DAC24 G4	DAC2 G3	DAC3 G5	DAC5 G5	DAC6 G5	DAC7 G5	DAC8 G5	DAC10 G5	DAC12 G5
12	DAC16 G4	DAC18 G4	DAC19 G4	DAC23 G4	DAC4 G3	DAC3 G3	DAC1 G3	DAC4 G5	DAC24 G6	DAC23 G6	DAC21 G6	DAC9 G5	DAC19 G6	DAC11 G5
11	DAC10 G3	DAC8 G3	DAC6 G3	DAC5 G3	DAC24 G2	DNC	DNC	DNC	DNC	DAC1 G7	DAC22 G6	DAC20 G6	DAC18 G6	DAC17 G6
10	DAC11 G3	DAC9 G3	DAC7 G3	AGND	AGND	AGND	AGND	AGND	AGND	AGND	AGND	DAC5 G7	DAC7 G7	DAC16 G6
9	DAC12 G3	AVSS G3	VREFL G3	VREFH G3	AVCC G3	AVSS S2	DGND	DGND	AVSS S3	AVCC G6	VREFH G6	VREFL G6	AVSS G6	DAC15 G6
8	DAC13 G3	AVSS G3	VREFL G3	VREFH G3	AVCC G3	AVCC S2	DVDD	DVDD	AVCC S3	AVCC G6	VREFH G6	VREFL G6	AVSS G6	DAC14 G6
7	DAC14 G2	AVSS G2	VREFL G2	VREFH G2	AVCC G2	AVCC S1	DVDD	DVDD	AVCC S4	AVCC G7	VREFH G7	VREFL G7	AVSS G7	DAC13 G7
6	DAC15 G2	AVSS G2	VREFL G2	VREFH G2	AVCC G2	AVSS S1	DGND	DGND	AVSS S4	AVCC G7	VREFH G7	VREFL G7	AVSS G7	DAC12 G7
5	DAC16 G2	DAC17 G2	DAC20 G2	DAC21 G2	DAC22 G2	AGND	AGND	CLEAR	AGND	DAC3 G7	DAC4 G7	DAC6 G7	DAC9 G7	DAC11 G7
4	DAC10 G1	DAC7 G1	DAC19 G2	DAC23 G2	DAC1 G1	RESET	CS	SCLK	LDAC	DAC2 G7	DAC25 G8	DAC21 G8	DAC8 G7	DAC10 G7
3	DAC11 G1	DAC8 G1	DAC18 G2	DAC3 G1	DAC2 G1	STATS	SDO	SDI	TRIGG	DAC26 G8	DAC24 G8	DAC19 G8	DAC17 G8	DAC16 G8
2	DAC12 G1	DAC9 G1	DAC6 G1	DAC5 G1	DAC4 G1	AGND	AGND	AGND	AGND	DAC23 G8	DAC22 G8	DAC20 G8	DAC18 G8	DAC15 G8
1	DAC13 G1	AVSS G1	VREFL G1	VREFH G1	AVCC G1	AGND	REF1	REF GND1	AGND	AVCC G8	VREFH G8	VREFL G8	AVSS G8	DAC14 G8

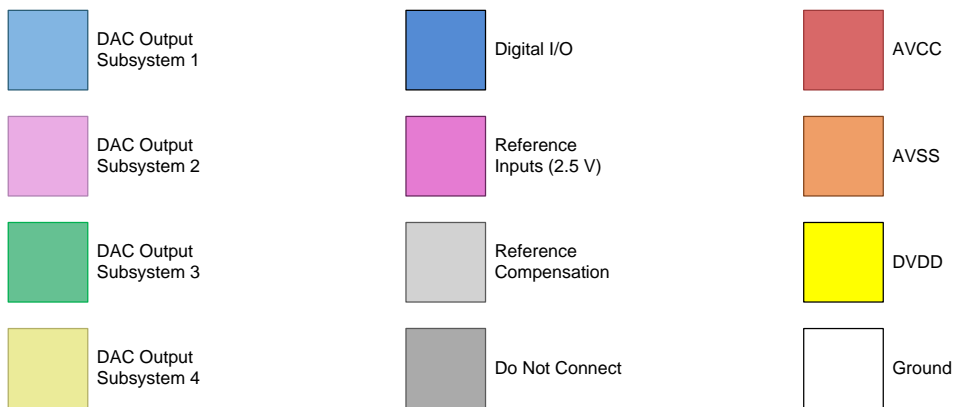

### Pin Functions

PIN		TYPE	DESCRIPTION
NAME	NO.		
AGND	D10, E10, F1, F2, F5, F10, G2, G5, G10, H2, H10, J1, J2, J5, J10, K10, L10	GND	Analog ground.
AVCC	E1, E6, E7, E8, E9, E14, F7, F8, J7, J8, K1, K6, K7, K8, K9, K14	PWR	Positive analog supply voltage. (11.2 V to 12.6 V). A 100-nF bypass capacitor for each AVCC_n (n = G1, G2, G3, G4, G5, G6, G7, G8, S1, S2, S3 or S4) is required; place as close as possible to the pins.
AVSS	B1, B6, B7, B8, B9, B14, F6, F9, J6, J9, N1, N6, N7, N8, N9, N14	PWR	Negative analog supply voltage. (-12.6V to -11.2V). A 100-nF bypass capacitor for each AVSS_n (n = G1, G2, G3, G4, G5, G6, G7, G8, S1, S2, S3 or S4) is required; place as close as possible to the pins.
$\overline{\text{CLEAR}}$	H5	I	Asynchronous clear control input, active low. When $\overline{\text{CLEAR}}$ is low, all DACs are loaded with code 000h. When $\overline{\text{CLEAR}}$ is high, all DACs return to normal operation.
$\overline{\text{CS}}$	G4	I	Serial data enable, active low. This input is the frame synchronization signal for the serial data.
DAC[1-13]_G1	A1, A2, A3, A4, B2, B3, B4, C2, D2, D3, E2, E3, E4	O	Subsystem 1 Regular DAC outputs: DAC group 1 and DAC group 2. Each DAC subsystem can be controlled independently through the serial interface.
DAC[14-26]_G2	A5, A6, A7, B5, C3, C4, C5, D4, D5, E5, E11	O	
DAC[1-13]_G3	A8, A9, A10, A11, B10, B11, C10, C11, D11, E12, F12, G12, G13	O	Subsystem 2 Regular DAC outputs: DAC group 3 and DAC group 4. Each DAC subsystem can be controlled independently through the serial interface.
DAC[14-24]_G4	A12, A13, A14, B12, B13, C12, C13, D12, D13, E13, F13	O	
DAC[3-13]_G5	H12, H13, J13, K13, L13, M12, M13, N13, P12, P13, P14	O	Subsystem 3 Regular DAC outputs: DAC group 5 and DAC group 6. Each DAC subsystem can be controlled independently through the serial interface.
DAC[14-26]_G6	J12, K12, L11, L12, M11, N11, N12, P8, P9, P10, P11	O	
DAC[1-13]_G7	K4, K5, K11, L5, M5, M10, N4, N5, N10, P4, P5, P6, P7	O	Subsystem 4 Regular DAC outputs: DAC group 7 and DAC group 8. Each DAC subsystem can be controlled independently through the serial interface.
DAC[14-26]_G8	K2, K3, L2, L3, L4, M2, M3, M4, N2, N3, P1, P2, P3	O	
DGND	G6, G9, H6, H9	GND	Digital ground. Ground reference point for all digital circuitry on the device.
DNC	F11, F14, G11, H11, J11, J14	—	Reserved for factory use. For proper operation, do not connect.
DVDD	G7, G8, H7, H8	PWR	Digital supply voltage. (3 V to 5.5 V). A 100-nF bypass capacitor is required; place as close as possible to the pins.
$\overline{\text{LDAC}}$	J4	I	Synchronous DAC load control input, active low. When $\overline{\text{LDAC}}$ is low, the DAC outputs are updated immediately after a register write. If left high during DAC register updates, bringing $\overline{\text{LDAC}}$ low causes all DAC outputs to update simultaneously.
$\overline{\text{RESET}}$	F4	I	Reset input, active low. Logic low on this pin causes the device to perform a hardware reset.
REFGND1	H1	GND	Reference ground. Ground reference point for REF1. REFGND1 should be star connected at the system GND source and not connected to the GND plane for best performance.
REFGND2	H14	GND	Reference ground. Ground reference point for REF2. REFGND2 should be star connected at the system GND source and not connected to the GND plane for best performance.
SCLK	H4	I	Serial interface clock.
SDI	H3	I	Serial interface data input. Data are clocked into the input shift register on each rising edge of SCLK.
SDO	G3	O	Serial interface data output. The SDO pin is in high impedance when $\overline{\text{CS}}$ is high. Data can be clocked out of the input shift register on either rising or falling edges of SCLK as specified by PHAINV in the CON register.
STATS	F3	O	DAC output status indicator. Identifies which of the two DAC data registers is active.
REF1	G1	I	Input voltage reference pin 1 (2.5 V). A 100-nF bypass capacitor between this pin and REFGND1 is required.
REF2	G14	I	Input voltage reference pin 2 (2.5 V). A 100-nF bypass capacitor between this pin and REFGND2 is required.

**Pin Functions (continued)**

PIN		TYPE	DESCRIPTION
NAME	NO.		
TRIGG	J3	I	Trigger input signal. Enables all DAC outputs to toggle between the two DAC data registers associated with each DAC. This functionality enables the device to operate as a square-wave generator. The DAC registers are prepared for toggle mode operation on a TRIGG rising edge and the outputs are toggled on each following TRIGG falling edge.
VREFH	D1, D6, D7, D8, D9, D14, L1, L6, L7, L8, L9, L14	O	Compensation capacitor connection for the internal 10.5 V reference voltage. A 100-nF bypass capacitor for each VREFH_n (n = G1, G2, G3, G4, G5, G6, G7 or G8) is required; place as close as possible to the pins.
VREFL	C1, C6, C7, C8, C9, C14, M1, M6, M7, M8, M9, M14	O	Compensation capacitor connection for the internal -10.5 V reference voltage. A 100-nF bypass capacitor for each VREFL_n (n = G1, G2, G3, G4, G5, G6, G7 or G8) is required; place as close as possible to the pins.

## 6 Specifications

### 6.1 Absolute Maximum Ratings

 over operating free-air temperature range (unless otherwise noted)<sup>(1)</sup>

		MIN	MAX	UNIT
Supply voltage	AV <sub>CC</sub> to DGND	-0.3	13	V
	AV <sub>SS</sub> to DGND	-13	0.3	
	DV <sub>DD</sub> to DGND	-0.3	6	
	AV <sub>CC</sub> to AV <sub>SS</sub>	-0.3	26	
	DGND to AGND	-0.3	0.3	
	DGND to REFGND[1,2]	-0.3	0.3	
Pin voltage	REF1 to REFGND1	-0.3	6	V
	REF2 to REFGND2	-0.3	6	
	DAC to DGND	AV <sub>SS</sub> - 0.3	AV <sub>CC</sub> + 0.3	
	CLEAR, $\overline{CS}$ , $\overline{LDAC}$ , $\overline{RESET}$ , SCLK, SDI, SDO, TRIGG, STATS to DGND	-0.3	DV <sub>DD</sub> + 0.3	
	VREFH to DGND	-0.3	AV <sub>CC</sub> + 0.3	
	VREFL to DGND	AV <sub>SS</sub> - 0.3	0.3	
Temperature	VREFH to adjacent VREFL	-0.3	26	°C
	Operating, T <sub>A</sub>	-40	85	
	Junction, T <sub>J</sub>	-40	150	
	Storage, T <sub>stg</sub>	-40	150	

(1) Stresses beyond those listed under *Absolute Maximum Ratings* may cause permanent damage to the device. These are stress ratings only, which do not imply functional operation of the device at these or any other conditions beyond those indicated under *Recommended Operating Conditions*. Exposure to absolute-maximum-rated conditions for extended periods may affect device reliability.

### 6.2 ESD Ratings

		VALUE	UNIT
V <sub>(ESD)</sub>	Electrostatic discharge	Human-body model (HBM), per ANSI/ESDA/JEDEC JS-001 <sup>(1)</sup>	±2000
		Charged-device model (CDM), per JEDEC specification JESD22-C101 <sup>(2)</sup>	±500

(1) JEDEC document JEP155 states that 500-V HBM allows safe manufacturing with a standard ESD control process.

(2) JEDEC document JEP157 states that 250-V CDM allows safe manufacturing with a standard ESD control process.

### 6.3 Recommended Operating Conditions

over operating free-air temperature range (unless otherwise noted)

	MIN	NOM	MAX	UNIT
<b>POWER SUPPLY</b>				
AV <sub>CC</sub>	11.2	12	12.6	V
AV <sub>SS</sub>	-12.6	-12	-11.2	V
DV <sub>DD</sub>	3	3.3	5.5	V
AV <sub>CC</sub> to AV <sub>SS</sub>	22.4	24	25.2	V
<b>DIGITAL INPUTS</b>				
Digital input voltage	0		DV <sub>DD</sub>	V
<b>REFERENCE INPUT</b>				
Reference input voltage, V <sub>REF</sub>	2.475	2.5	2.525	V
<b>TEMPERATURE</b>				
Operating ambient temperature, T <sub>A</sub>	-40		85	°C

## 6.4 Thermal Information

THERMAL METRIC <sup>(1)</sup>		DAC60096	
		ZEB (NFBGA)	UNIT
		196 BALLS	
R <sub>θJA</sub>	Junction-to-ambient thermal resistance	21.4	°C/W
R <sub>θJC(top)</sub>	Junction-to-case (top) thermal resistance	7.5	°C/W
R <sub>θJB</sub>	Junction-to-board thermal resistance	5.1	°C/W
ψ <sub>JT</sub>	Junction-to-top characterization parameter	0.4	°C/W
ψ <sub>JB</sub>	Junction-to-board characterization parameter	5.0	°C/W
R <sub>θJC(bot)</sub>	Junction-to-case (bottom) thermal resistance	N/A	°C/W

(1) For more information about traditional and new thermal metrics, see the *Semiconductor and IC Package Thermal Metrics* application report, [SPRA953](#).

## 6.5 Electrical Characteristics: DAC DC

at AV<sub>CC</sub> = 11.2 V to 12.6 V, AV<sub>SS</sub> = -12.6 V to -11.2 V, DV<sub>DD</sub> = 3 V to 5.5 V, AGND = DGND = REFGND[1,2] = 0 V, REF1 = REF2 = 2.5 V (specifications exclude any reference contributions), no load on DACs, and T<sub>A</sub> = -40°C to +85°C (unless otherwise noted)

PARAMETER	TEST CONDITIONS	MIN	TYP	MAX	UNIT
<b>STATIC PERFORMANCE</b>					
Resolution		12			Bits
INL	Relative accuracy		±0.15	±1	LSB
DNL	Differential nonlinearity	Specified 12-bit monotonic	±0.1	±0.9	LSB
Gain error	T <sub>A</sub> = 25°C		±0.05	±0.15	%FSR
Zero-code error	T <sub>A</sub> = 25°C, code 000h		±2	±7	mV
Gain error drift			±1		ppm/°C
Zero-code error drift			±1		ppm/°C
<b>OUTPUT CHARACTERISTICS</b>					
Output voltage		-10.5		10.5	V
Output impedance			41		kΩ
DC crosstalk	Measured channel at code 000h, all others transition from code 7FFh to 02Bh		0.5		LSB
Settling time	DAC output transition: code 800h to 7FFh to within 1 LSB, 6x load: R <sub>(SERIES)</sub> = 17 kΩ, C <sub>LOAD</sub> = 300 pF		160		μs
	DAC output transition: code 800h to 7FFh to within 1 LSB, 1x load: R <sub>(SERIES)</sub> = 100 kΩ, C <sub>LOAD</sub> = 50 pF		65		
Output noise	T <sub>A</sub> = 25°C, 1 kHz, code 000h		60		nV/√Hz

## 6.6 Electrical Characteristics: Square-Wave Output

at  $V_{CC} = 11.2\text{ V}$  to  $12.6\text{ V}$ ,  $V_{SS} = -12.6\text{ V}$  to  $-11.2\text{ V}$ ,  $DV_{DD} = 3\text{ V}$  to  $5.5\text{ V}$ ,  $AGND = DGND = REFGND[1,2] = 0\text{ V}$ ,  $REF1 = REF2 = 2.5\text{ V}$  (specifications exclude any reference contributions), no load on DACs, and  $T_A = -40^\circ\text{C}$  to  $+85^\circ\text{C}$  (unless otherwise noted)

PARAMETER	TEST CONDITIONS	MIN	TYP	MAX	UNIT
<b>DAC OUTPUTS – 6x LOAD: <math>R_{(SERIES)} = 17\text{ k}\Omega</math>, <math>C_{LOAD} = 300\text{ pF}</math></b>					
Frequency	For amplitude $\geq 9.1\text{ V}_{RMS}$ , amplitude = $\pm 10.5\text{ V}_{PP}$ , codes 7FFh to 801h		3		kHz
Amplitude	Frequency = 3 kHz, amplitude = $\pm 10.5\text{ V}_{PP}$ , codes 7FFh to 801h	9.1			$V_{RMS}$
	Frequency = 5 kHz, amplitude = $\pm 10.5\text{ V}_{PP}$ , codes 7FFh to 801h	8			$V_{RMS}$
Amplitude step precision	Frequency = 3 kHz, amplitude $\geq 1\text{ V}_{RMS}$			6	$mV_{RMS}$
Amplitude temperature drift	Frequency = 3 kHz, amplitude = $\pm 5\text{ V}_{PP}$ , codes 3CFh to C31h			5	$mV_{RMS}$
	Frequency = 3 kHz, amplitude = $\pm 10.5\text{ V}_{PP}$ , codes 7FFh to 801h			15	$mV_{RMS}$
Offset voltage	Frequency = 3 kHz, amplitude = $\pm 5\text{ V}_{PP}$ , codes 3CFh to C31h	-10		10	mV
	Frequency = 3 kHz, amplitude = $\pm 10.5\text{ V}_{PP}$ , codes 7FFh to 801h	-10		10	mV
Rise and fall time	Frequency = 3 kHz, amplitude = $\pm 10.5\text{ V}_{PP}$ , 10% to 90%, codes 7FFh to 801h		40		$\mu\text{s}$
<b>DAC OUTPUTS – 1x LOAD: <math>R_{(SERIES)} = 100\text{ k}\Omega</math>, <math>C_{LOAD} = 50\text{ pF}</math> <sup>(1)</sup></b>					
Frequency	For amplitude $\geq 9.1\text{ V}_{RMS}$ , amplitude = $\pm 10.5\text{ V}_{PP}$ , codes 7FFh and 801h		5		kHz
Amplitude	Frequency = 3 kHz, amplitude = $\pm 10.5\text{ V}_{PP}$ , codes 7FFh to 801h	10			$V_{RMS}$
	Frequency = 5 kHz, amplitude = $\pm 10.5\text{ V}_{PP}$ , codes 7FFh to 801h	9.5			$V_{RMS}$
Amplitude step precision	Frequency = 3 kHz, amplitude $\geq 1\text{ V}_{RMS}$			7	$mV_{RMS}$
Amplitude temperature drift	Frequency = 3 kHz, amplitude = $\pm 5\text{ V}_{PP}$ , codes 3CFh to C31h			5	$mV_{RMS}$
	Frequency = 3 kHz, amplitude = $\pm 10.5\text{ V}_{PP}$ , codes 7FFh to 801h			15	$mV_{RMS}$
Offset voltage	Frequency = 3 kHz, amplitude = $\pm 5\text{ V}_{PP}$ , codes 3CFh to C31h	-10		10	mV
	Frequency = 3 kHz, amplitude = $\pm 10.5\text{ V}_{PP}$ , codes 7FFh to 801h	-10		10	mV
Rise and fall time	Frequency = 3 kHz, amplitude = $\pm 10.5\text{ V}_{PP}$ , 10% to 90%, codes 7FFh to 801h		10		$\mu\text{s}$

(1) Specified by design and characterization. Not tested during production.



## 6.7 Electrical Characteristics: General

at  $V_{CC} = 11.2\text{ V to }12.6\text{ V}$ ,  $V_{SS} = -12.6\text{ V to }-11.2\text{ V}$ ,  $DV_{DD} = 3\text{ V to }5.5\text{ V}$ ,  $AGND = DGND = REFGND[1,2] = 0\text{ V}$ ,  $REF1 = REF2 = 2.5\text{ V}$  (specifications exclude any reference contributions), no load on DACs, and  $T_A = -40^\circ\text{C to }+85^\circ\text{C}$  (unless otherwise noted)

PARAMETER	TEST CONDITIONS	MIN	TYP	MAX	UNIT	
<b>EXTERNAL REFERENCE INPUTS</b>						
$V_{REF}$	Input voltage range	REF1 and REF2 input pins	2.475	2.5	2.525	V
	Reference input current	Per input pin		1		$\mu\text{A}$
<b>DIGITAL LOGIC</b>						
$V_{IH}$	High-level input voltage		$0.7 \times DV_{DD}$			V
$V_{IL}$	Low-level input voltage			$0.3 \times DV_{DD}$		V
$V_{OH}$	High-level output voltage	$I_{LOAD} = 1\text{ mA}$ , SDO2x = 01	$DV_{DD} - 0.2$			V
$V_{OL}$	Low-level output voltage	$I_{LOAD} = -1\text{ mA}$ , SDO2x = 01		0.4		V
	Input capacitance		20			pF
<b>POWER REQUIREMENTS <sup>(1)</sup></b>						
$I_{(AVCC)}$	$AV_{CC}$ supply current	6x load: $R_{(SERIES)} = 17\text{ k}\Omega$ , $C_{LOAD} = 300\text{ pF}$ frequency = 3 kHz 48 DAC outputs, codes 7FFh and 801h 48 DAC outputs, codes 117h and EE9h		18.1	25	mA
$I_{(AVSS)}$	$AV_{SS}$ supply current		-25	-18.1		mA
$I_{(DVDD)}$	$DV_{DD}$ supply current			2	10	mA
	Power consumption			440		mW
$I_{(AVCC)}$	$AV_{CC}$ supply current	1x load: $R_{(SERIES)} = 100\text{ k}\Omega$ , $C_{LOAD} = 50\text{ pF}$ frequency = 3 kHz 48 DAC outputs, codes 7FFh and 801h 48 DAC outputs, codes 117h and EE9h <sup>(2)</sup>		17	22	mA
$I_{(AVSS)}$	$AV_{SS}$ supply current		-22	-17		mA
$I_{(DVDD)}$	$DV_{DD}$ supply current			2	10	mA
	Power consumption			415		mW
$I_{(AVCC)}$	$AV_{CC}$ supply current	6x load: $R_{(SERIES)} = 17\text{ k}\Omega$ , $C_{LOAD} = 300\text{ pF}$ frequency = 3 kHz All DAC outputs, codes 02Bh and FD5h		25	30	mA
$I_{(AVSS)}$	$AV_{SS}$ supply current		-30	-25		mA
$I_{(DVDD)}$	$DV_{DD}$ supply current			2	10	mA
	Power consumption			650	760	mW

- (1) Power requirements tested unloaded during production. Load current contribution to power consumption specified by design and characterization.
- (2) Specified by design and characterization. Not tested during production.

## 6.8 Timing Requirements<sup>(1)(2)</sup>

at  $V_{CC} = 11.2\text{ V to }12.6\text{ V}$ ,  $V_{SS} = -12.6\text{ V to }-11.2\text{ V}$ ,  $DV_{DD} = 3\text{ V to }5.5\text{ V}$ ,  $AGND = DGND = REFGND[1,2] = 0\text{ V}$ ,  $REF1 = REF2 = 2.5\text{ V}$  (specifications exclude any reference contributions), no load on DACs, and  $T_A = -40^\circ\text{C to }+85^\circ\text{C}$  (unless otherwise noted)

			MIN	NOM	MAX	UNIT
<b>SERIAL INTERFACE – DEFAULT MODE: SDO2X = 01, PHAINV = 01</b>						
$f_{SCLK}$	SCLK frequency	Write operation			32	MHz
		Read operation			18	MHz
$t_{PH}$	SCLK pulse width high	Write operation	14			ns
		Read operation	26			ns
$t_{PL}$	SCLK pulse width low	Write operation	14			ns
		Read operation	26			ns
$t_{SU}$	SDI setup		5			ns
$t_H$	SDI hold		10			ns
$t_{CSS}$	$\overline{CS}$ setup		10			ns
$t_{CSH}$	$\overline{CS}$ hold		20			ns
$t_{IAG}$	Inter-access gap		70			ns
$t_{ODZ}$	SDO driven to tri-state	Read operation	0		20	ns
$t_{OZD}$	SDO tri-state to driven	Read operation	0		20	ns
$t_{OD1}$	SDO output delay	Read operation	0		20	ns
<b>SERIAL INTERFACE – FAST MODE: SDO2X = 10, PHAINV = 10</b>						
$f_{SCLK}$	SCLK frequency	Write operation			32	MHz
		Read operation			32	MHz
$t_{PH}$	SCLK pulse width high	Write operation	14			ns
		Read operation	14			ns
$t_{PL}$	SCLK pulse width low	Write operation	14			ns
		Read operation	14			ns
$t_{SU}$	SDI setup		5			ns
$t_H$	SDI hold		10			ns
$t_{CSS}$	$\overline{CS}$ setup		10			ns
$t_{CSH}$	$\overline{CS}$ hold		20			ns
$t_{IAG}$	Inter-access gap		70			ns
$t_{ODZ}$	SDO driven to tri-state	Read operation	0		20	ns
$t_{OZD}$	SDO tri-state to driven	Read operation	0		20	ns
$t_{OD2}$	SDO output delay	Read operation	0		20	ns
<b>DIGITAL LOGIC</b>						
$t_{RESETDLY}$	Reset delay	Delay from power-on-reset to normal operation		100	250	$\mu\text{s}$
		Delay from hardware reset to normal operation		10	50	$\mu\text{s}$
		Delay from software reset to normal operation		10	50	$\mu\text{s}$
$t_{RESETWD}$	$\overline{RESET}$ pulse width		500			ns
$t_{LDACS}$	$\overline{LDAC}$ setup		0			ns
$t_{LDACH}$	$\overline{LDAC}$ hold		0			ns
$t_{TRIGH}$	TRIGG pulse width high		30			ns
$t_{TRIGL}$	TRIGG pulse width low		30			ns
$t_{STADLY}$	STATS output delay				25	ns

(1) Specified by design and characterization. Not tested during production.

(2) SDO loaded with 10-pF load capacitance for SDO timing specifications.

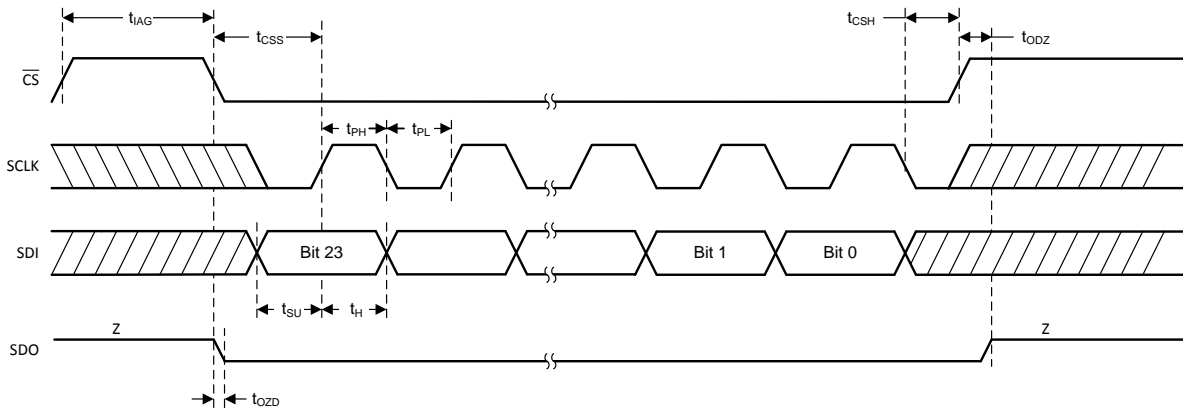

**Figure 1. Serial Interface Write Timing Diagram**

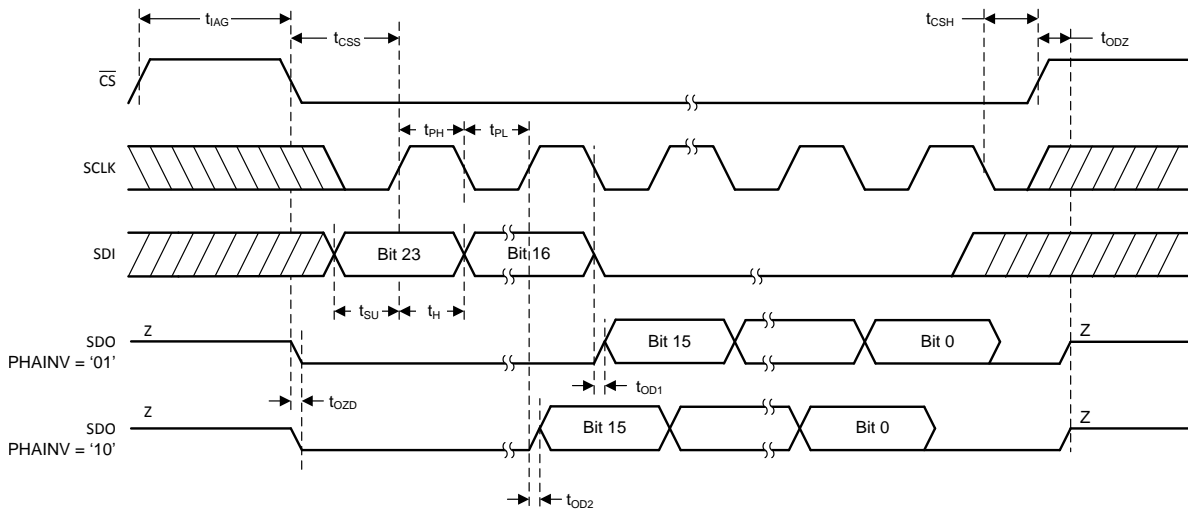

**Figure 2. Serial Interface Read Timing Diagram**

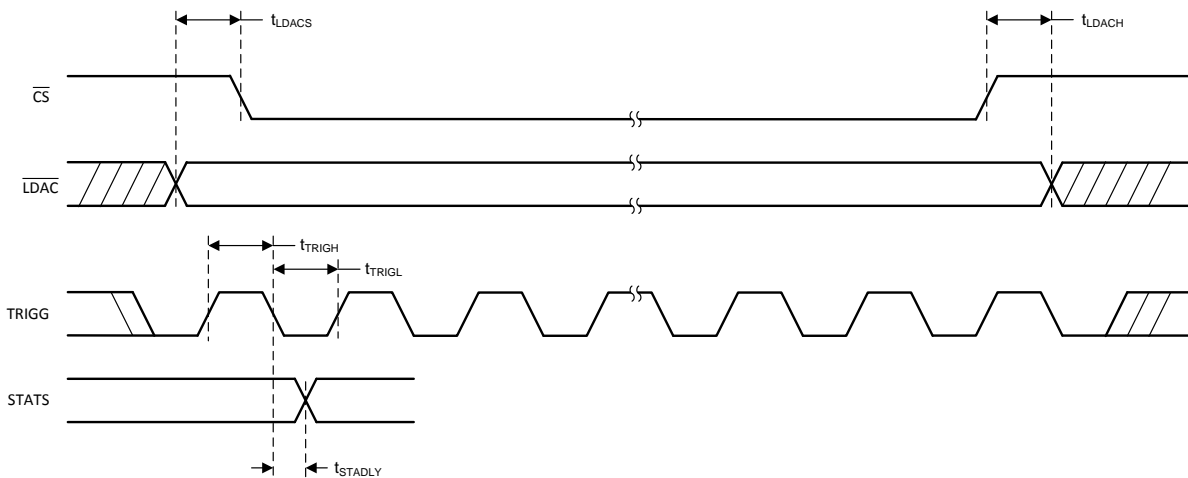

**Figure 3. Digital Logic Timing Diagram**

### 6.9 Typical Characteristics: DC Mode

at  $AV_{CC} = 12\text{ V}$ ,  $AV_{SS} = -12\text{ V}$ ,  $DV_{DD} = 3.3\text{ V}$ ,  $AGND = DGND = REFGND[1,2] = 0\text{ V}$ ,  $REF1 = REF2 = 2.5\text{ V}$  (specifications exclude any reference contributions), no load on DACs, and  $T_A = 25^\circ\text{C}$  (unless otherwise noted)

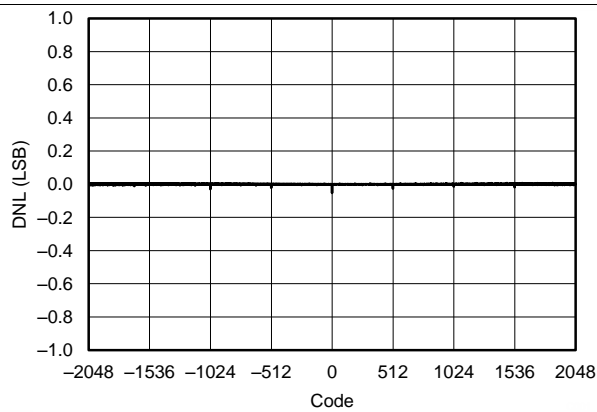

Figure 4. Differential Linearity Error (DNL)

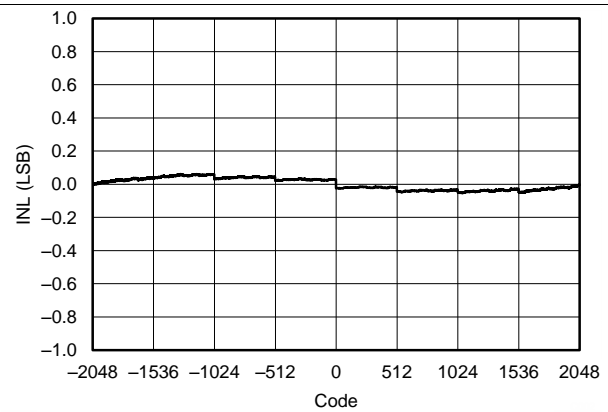

Figure 5. Integral Linearity Error (INL)

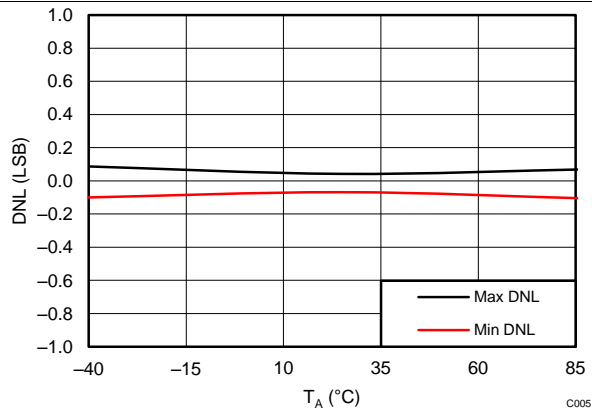

Figure 6. DNL vs Temperature

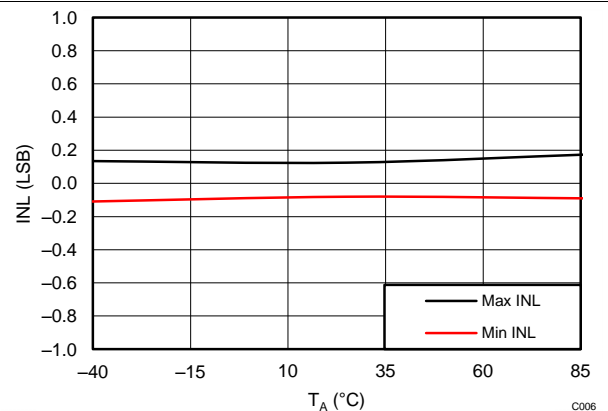

Figure 7. INL vs Temperature

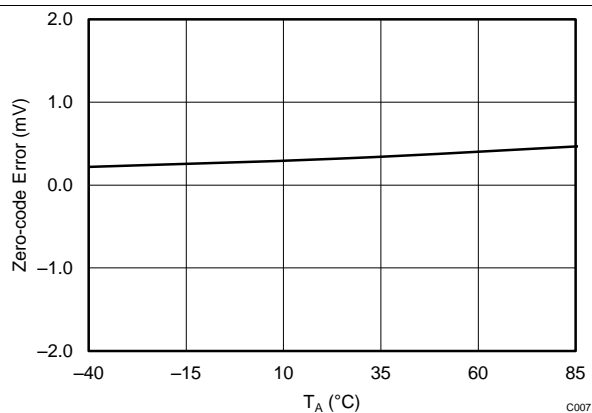

Figure 8. Zero-Code Error vs Temperature

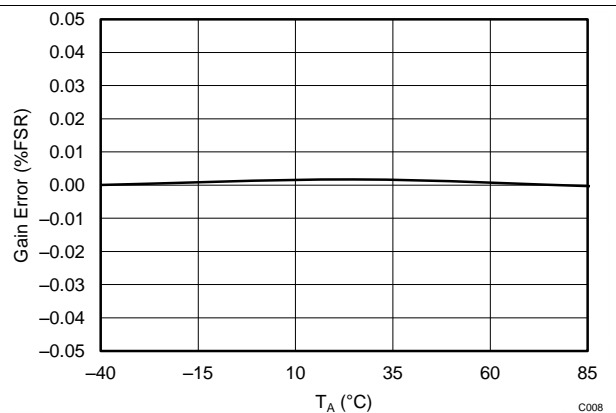
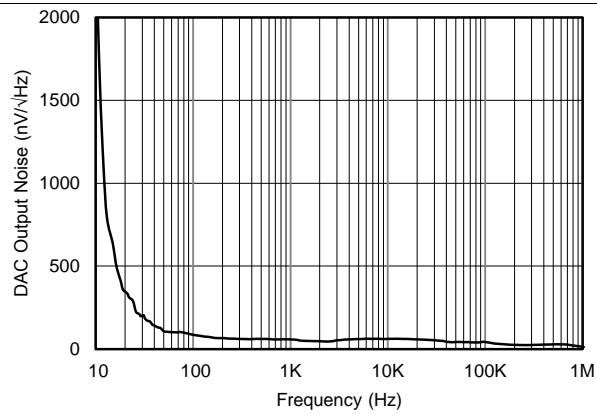

Figure 9. Gain Error vs Temperature

**Typical Characteristics: DC Mode (continued)**

at  $AV_{CC} = 12\text{ V}$ ,  $AV_{SS} = -12\text{ V}$ ,  $DV_{DD} = 3.3\text{ V}$ ,  $AGND = DGND = REFGND[1,2] = 0\text{ V}$ ,  $REF1 = REF2 = 2.5\text{ V}$  (specifications exclude any reference contributions), no load on DACs, and  $T_A = 25^\circ\text{C}$  (unless otherwise noted)



**Figure 10. DAC Output Noise vs Frequency**

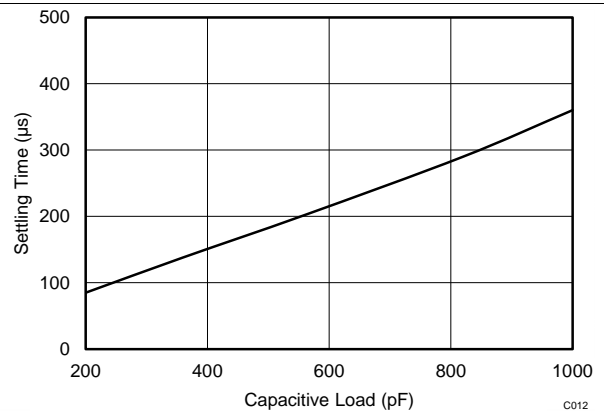

**Figure 11. Settling Time Amplitude vs Capacitive Load**

### 6.10 Typical Characteristics: Toggle Mode

at  $AV_{CC} = 12\text{ V}$ ,  $AV_{SS} = -12\text{ V}$ ,  $DV_{DD} = 3.3\text{ V}$ ,  $AGND = DGND = REFGND[1,2] = 0\text{ V}$ ,  $REF1 = REF2 = 2.5\text{ V}$  (specifications exclude any reference contributions), no load on DACs, and  $T_A = 25^\circ\text{C}$  (unless otherwise noted)

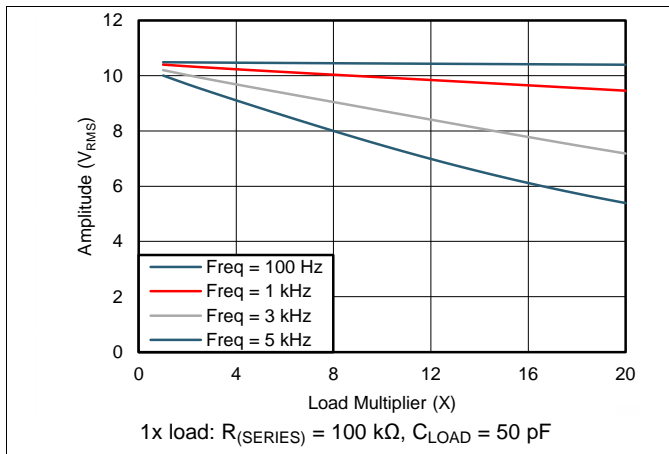

Figure 12. Maximum Amplitude vs Capacitive Load

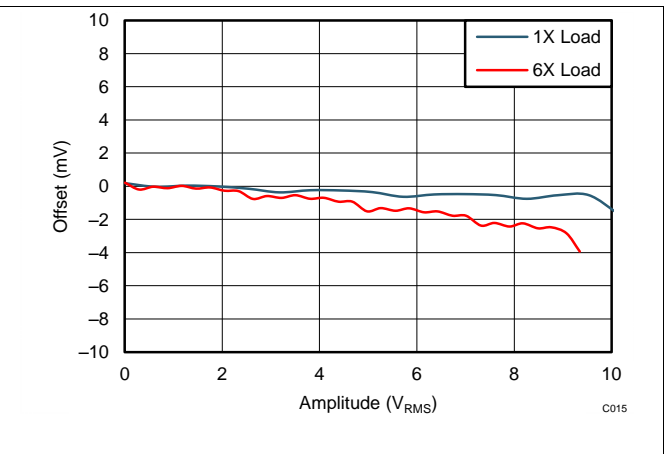

Figure 13. Offset vs Amplitude

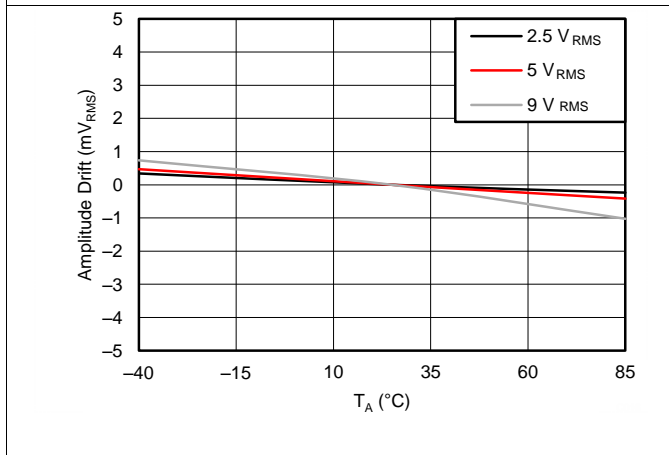

Figure 14. Amplitude Drift vs Temperature

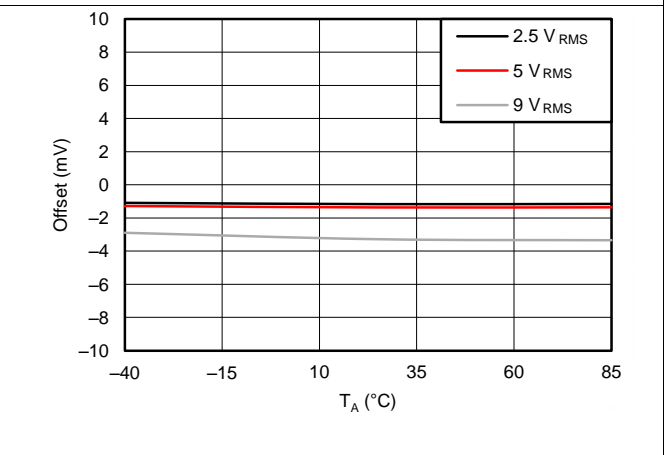

Figure 15. Offset vs Temperature

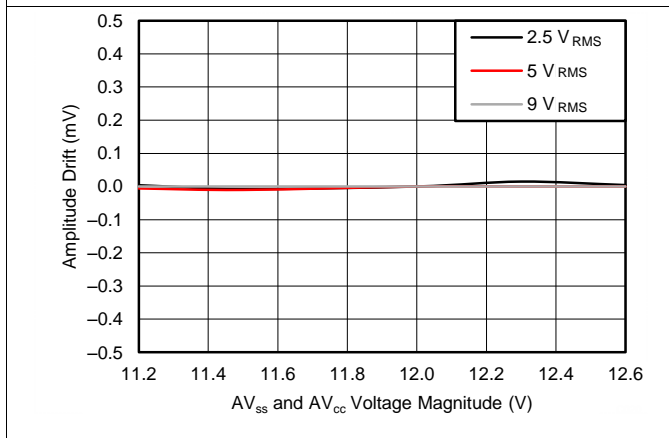

Figure 16. Amplitude Drift vs Supply Voltage

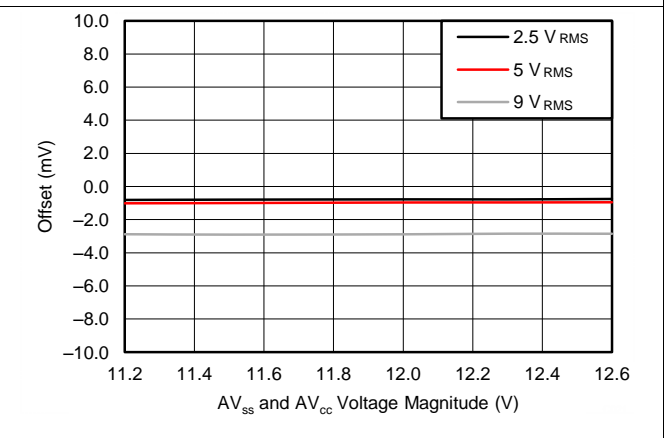

Figure 17. Offset vs Supply Voltage

### 6.11 Typical Characteristics, General

at  $AV_{CC} = 12\text{ V}$ ,  $AV_{SS} = -12\text{ V}$ ,  $DV_{DD} = 3.3\text{ V}$ ,  $AGND = DGND = REFGND[1,2] = 0\text{ V}$ ,  $REF1 = REF2 = 2.5\text{ V}$  (specifications exclude any reference contributions), no load on DACs, and  $T_A = 25^\circ\text{C}$  (unless otherwise noted)

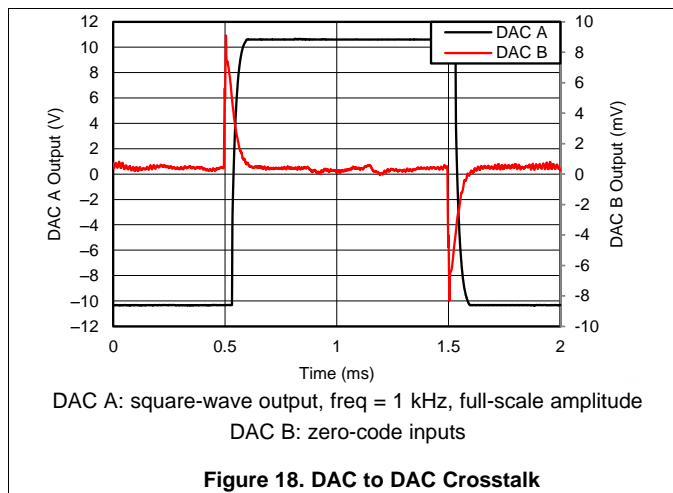

Figure 18. DAC to DAC Crosstalk

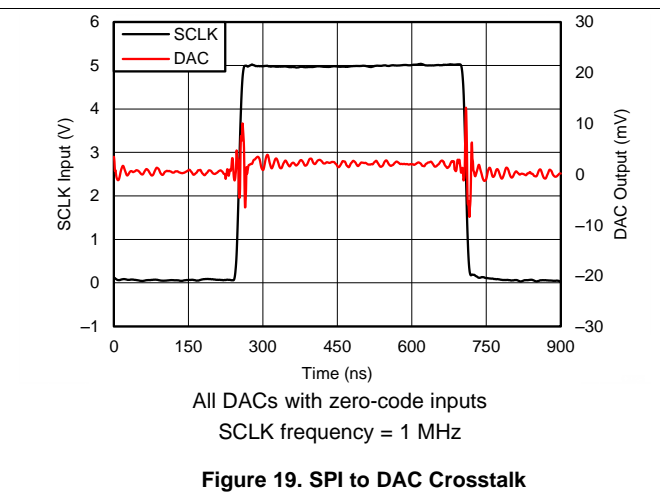

Figure 19. SPI to DAC Crosstalk

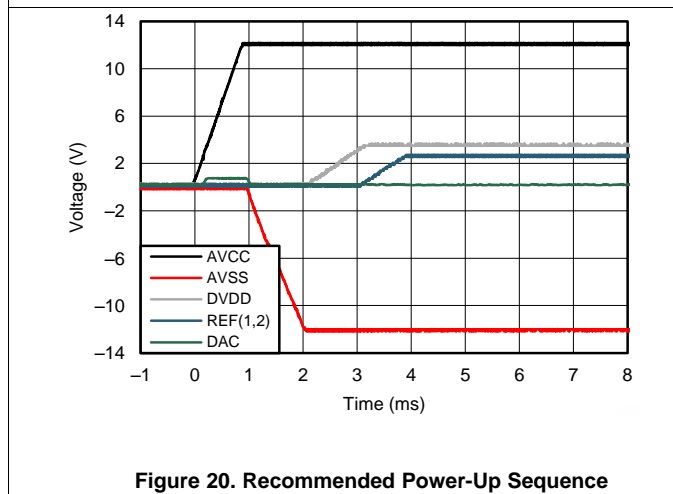

Figure 20. Recommended Power-Up Sequence

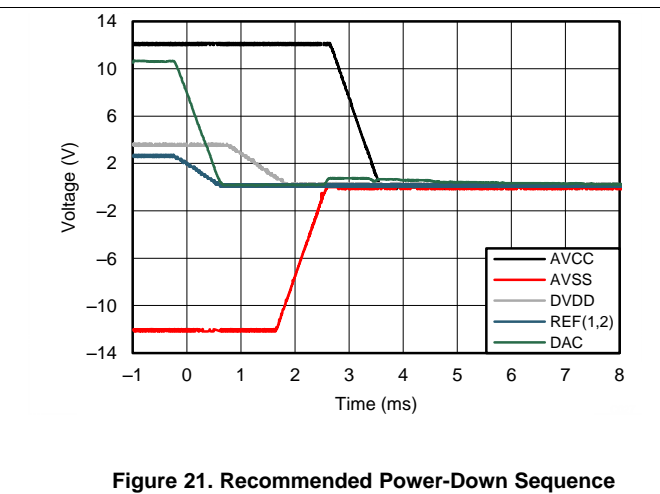

Figure 21. Recommended Power-Down Sequence

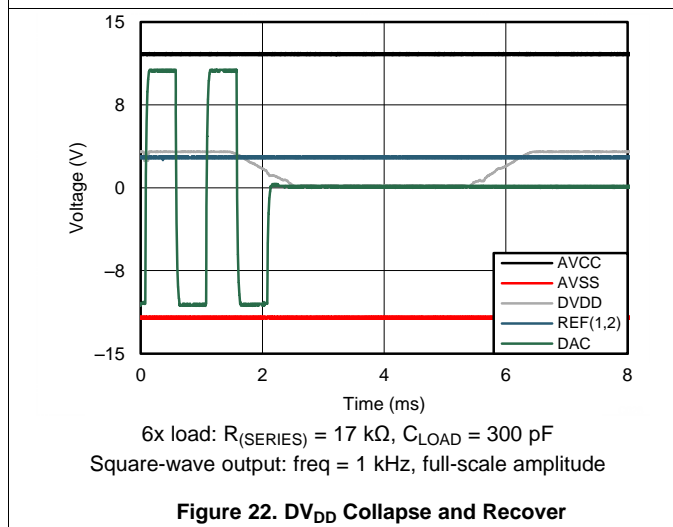

Figure 22.  $DV_{DD}$  Collapse and Recover

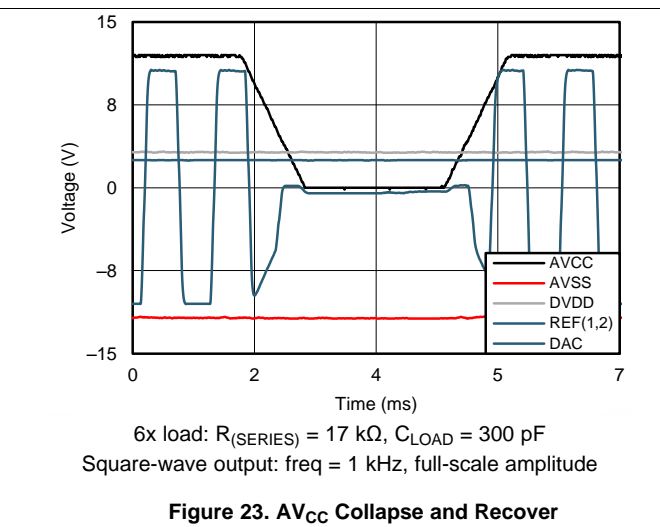
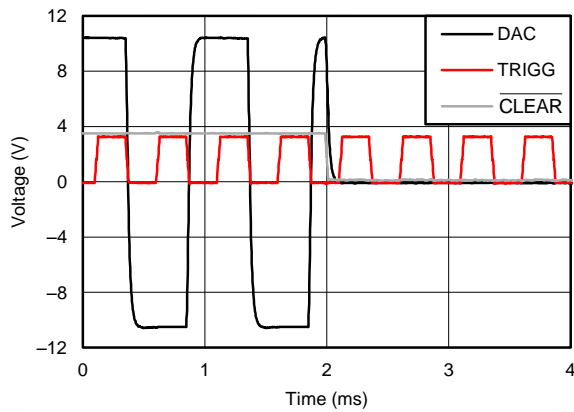

Figure 23.  $AV_{CC}$  Collapse and Recover

Typical Characteristics, General (continued)

at  $AV_{CC} = 12\text{ V}$ ,  $AV_{SS} = -12\text{ V}$ ,  $DV_{DD} = 3.3\text{ V}$ ,  $AGND = DGND = REFGND[1,2] = 0\text{ V}$ ,  $REF1 = REF2 = 2.5\text{ V}$  (specifications exclude any reference contributions), no load on DACs, and  $T_A = 25^\circ\text{C}$  (unless otherwise noted)



6x load:  $R_{(SERIES)} = 17\text{ k}\Omega$ ,  $C_{LOAD} = 300\text{ pF}$   
 Square-wave output: freq = 1 kHz, full-scale amplitude

Figure 24. Normal to Clear State Transition

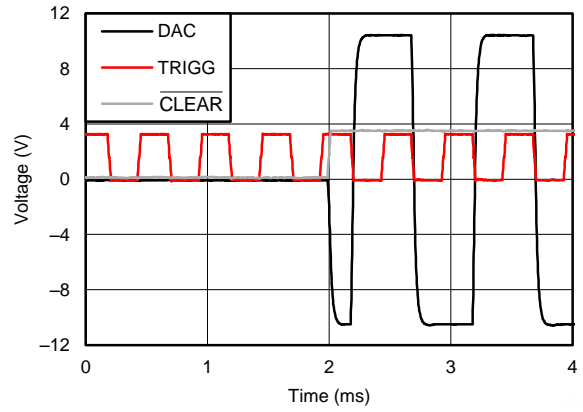

6x load:  $R_{(SERIES)} = 17\text{ k}\Omega$ ,  $C_{LOAD} = 300\text{ pF}$   
 Square-wave output: freq = 1 kHz, full-scale amplitude

Figure 25. Clear State to Normal Transition

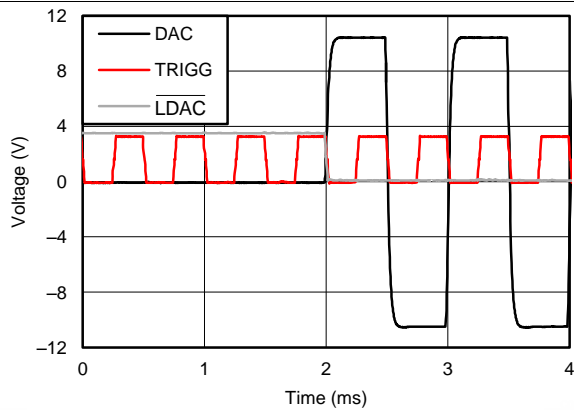

6x load:  $R_{(SERIES)} = 17\text{ k}\Omega$ ,  $C_{LOAD} = 300\text{ pF}$   
 Square-wave output: freq = 1 kHz, full-scale amplitude

Figure 26. LDAC DAC Transition

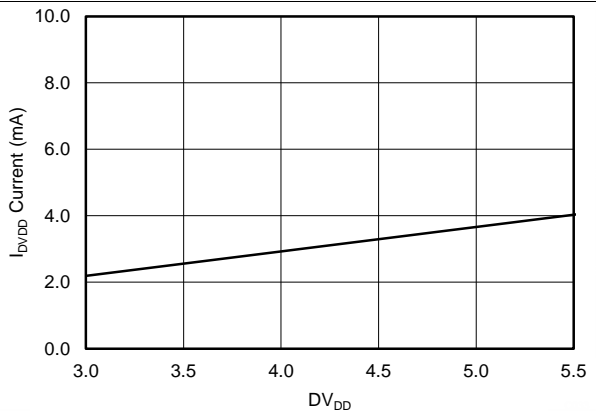

No DAC load  
 Square-wave output: freq = 3 kHz, full-scale amplitude

Figure 27.  $DV_{DD}$  Current Consumption

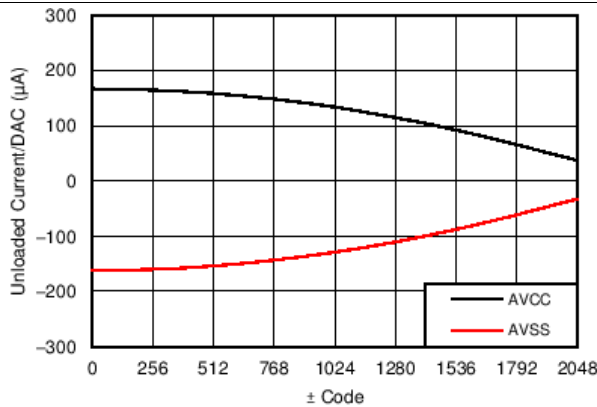

No DAC load,  $DV_{DD} = 3.3\text{ V}$   
 Square-wave output: freq = 3 kHz

Figure 28. Unloaded  $AV_{CC}/AV_{SS}$  Current Consumption

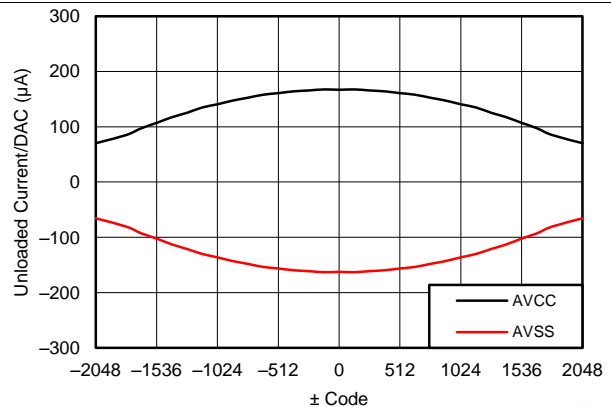

No DAC load, DC output,  $DV_{DD} = 3.3\text{ V}$

Figure 29. Unloaded  $AV_{CC}/AV_{SS}$  Current Consumption



**Typical Characteristics, General (continued)**

at  $AV_{CC} = 12\text{ V}$ ,  $AV_{SS} = -12\text{ V}$ ,  $DV_{DD} = 3.3\text{ V}$ ,  $AGND = DGND = REFGND[1,2] = 0\text{ V}$ ,  $REF1 = REF2 = 2.5\text{ V}$  (specifications exclude any reference contributions), no load on DACs, and  $T_A = 25^\circ\text{C}$  (unless otherwise noted)

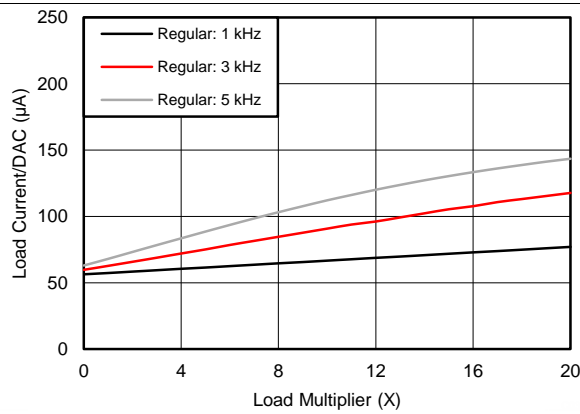

1x load:  $R_{(SERIES)} = 100\text{ k}\Omega$ ,  $C_{LOAD} = 50\text{ pF}$ ,  $DV_{DD} = 3.3\text{ V}$   
Square-wave output, full-scale amplitude

**Figure 30.  $AV_{CC}$  Load Current Consumption**

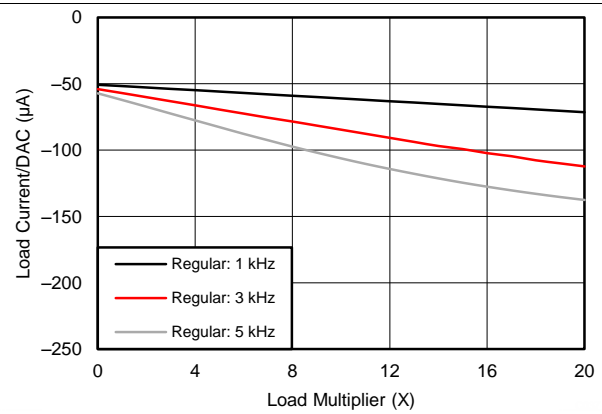

1x load:  $R_{(SERIES)} = 100\text{ k}\Omega$ ,  $C_{LOAD} = 50\text{ pF}$ ,  $DV_{DD} = 3.3\text{ V}$   
Square-wave output, full-scale amplitude

**Figure 31.  $AV_{SS}$  Load Current Consumption**

## 7 Detailed Description

### 7.1 Overview

The DAC60096 is a low-power, 96-channel, 12-bit, digital-to-analog converter (DAC). The device provides  $\pm 10.5\text{-V}$  unbuffered bipolar voltage outputs while maintaining extremely low-power operation and good linearity. The device integrates dedicated reference buffers that enable operation from an external 2.5-V reference source.

The DAC60096 can be set up to clear or update all DACs simultaneously. In addition a versatile external conversion trigger allows each DAC to operate as an amplitude-independent square-wave generator. The device incorporates a reset circuit that ensures all DAC outputs power up and remain at zero scale prior to device configuration.

The DAC60096 features simplify the design of systems requiring a high number of precise analog control signals such as those found in optical communications switches and attenuators.

The DAC60096 is designed as four DAC subsystems. Each DAC subsystem is configured independently through a high speed 4-wire serial interface compatible with industry standard microprocessors and microcontrollers. The DAC60096 is characterized for operation over the temperature range of  $-40^{\circ}\text{C}$  to  $+85^{\circ}\text{C}$ , and is available in a 196-ball, 15-mm x 15-mm, 1-mm pitch BGA package.

### 7.2 Functional Block Diagram

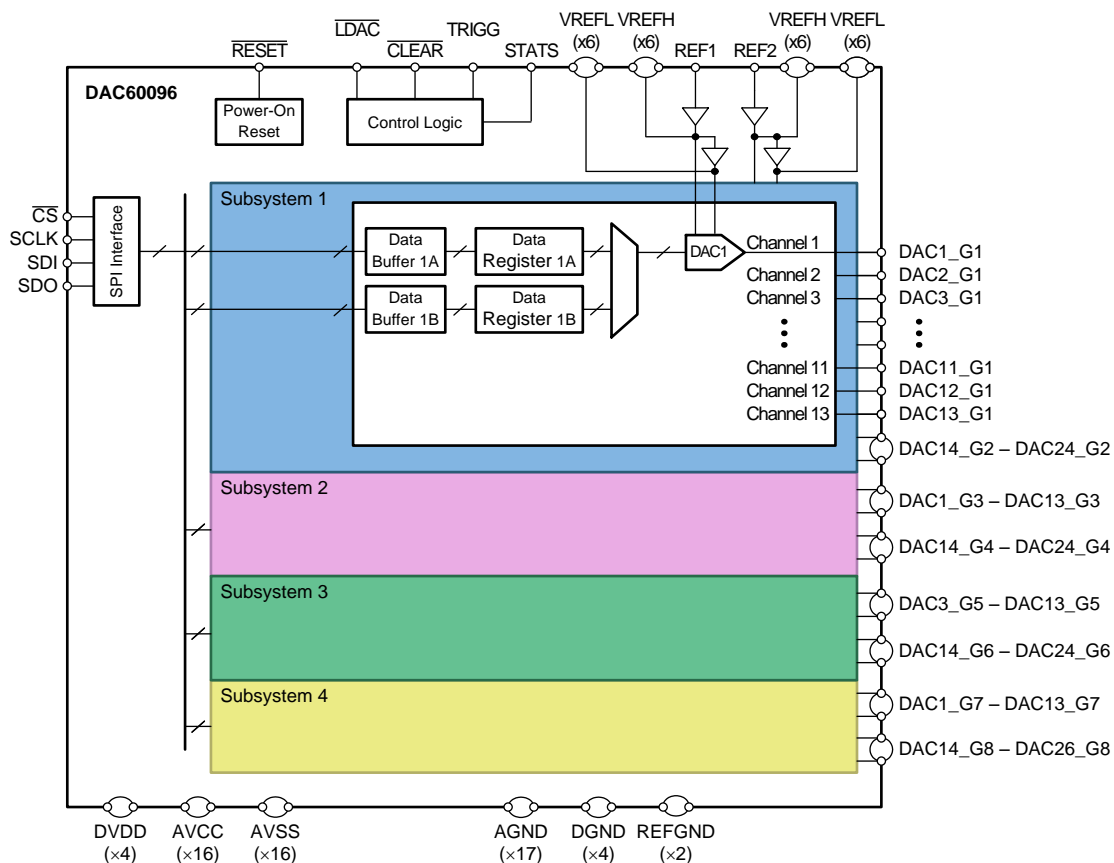

### 7.3 Feature Description

#### 7.3.1 Digital-to-Analog Converters (DACs)

The DAC60096 is a 96-channel, 12-bit digital-to-analog converter (DAC) with integrated reference buffers. Each DAC output consists of an R-2R ladder configuration as shown in Figure 32.

The DAC60096 includes reference buffers that enable bipolar DAC output voltages of ±10.5 V from a 2.5-V reference source. The outputs of the reference buffers drive the R-2R ladders.

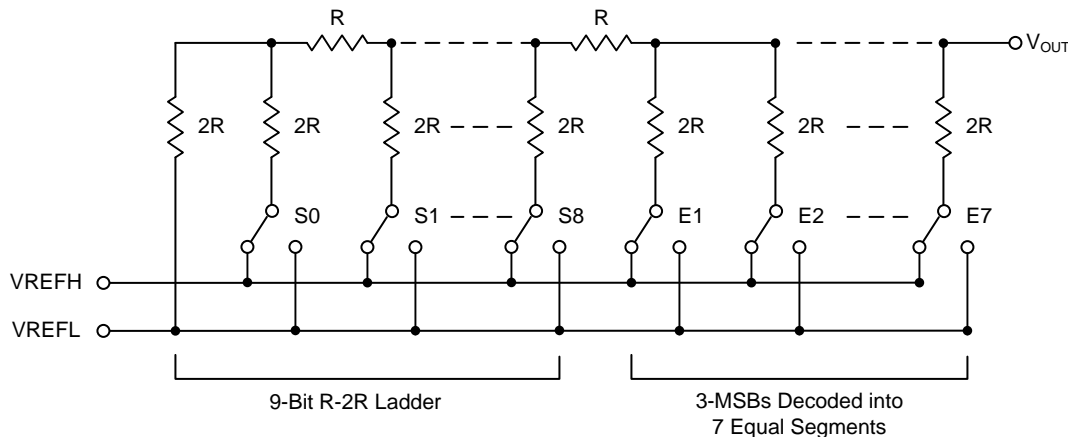

Figure 32. R-2R Ladder Configuration

##### 7.3.1.1 DAC Transfer Function

The DAC60096 integrates dedicated reference buffers that enable operation from an external 2.5-V reference source. The reference buffers generate the voltages, VREFH and VREFL, required to drive the DAC R-2R ladders.

$$V_{REFH} = V_{REF} \times \frac{10.5}{2.5} \tag{1}$$

$$V_{REFL} = -1 \times V_{REFH} \tag{2}$$

where  $V_{REF}$  is the reference input voltage at pins REF1 and REF2.

Input data are written to the individual DAC data registers in 12-bit twos complement format. After power-on or a reset event, all DAC registers are set to zero scale. The DAC transfer function is given by Equation 3.

$$V_{OUT} = \frac{Code}{4096} \times (V_{REFH} - V_{REFL}) \tag{3}$$

where *Code* is the signed decimal equivalent of the binary code loaded to the DAC register and ranges from -2048 to 2047 (See Table 1).

Table 1. DAC Data Format

DIGITAL CODE	SIGNED DECIMAL VALUE	DAC OUTPUT VOLTAGE (V)
0111 1111 1111	+2047	10.49487
0111 1111 1110	+2046	10.48975
0000 0000 0001	+1	0.005127
0000 0000 0000	0	0
1111 1111 1111	-1	-0.005127
1000 0000 0001	-2047	-10.49487
1000 0000 0000	-2048	-10.5

### 7.3.1.2 DAC Register Structure

Each DAC in the device incorporates two data registers: Register A and Register B. These two data registers and the TRIGG pin enable toggle mode operation. Alternatively, if the TRIGG pin is left fixed the device is in DC mode operation and only one of the data registers is used to control the DAC output (Register A by default).

Data written to the DAC data registers is initially stored in the DAC buffer registers. Transfer of data from the DAC buffer registers to the active DAC registers can be set to happen immediately (asynchronous mode) or initiated by an LDAC trigger (synchronous mode). After data are transferred to the DAC active registers, the DAC outputs are updated. When the host reads from a DAC data register, the value held in the DAC buffer register is returned (not the value held in the DAC active register).

The DAC update mode is determined by the status of the  $\overline{\text{LDAC}}$  input pin. If the  $\overline{\text{LDAC}}$  pin is held low the device is in asynchronous mode. In asynchronous mode, a write to a DAC data register results in an immediate update of the DAC active register and the corresponding output. If  $\overline{\text{LDAC}}$  is held high, the device is in synchronous mode. In synchronous mode, writing to a DAC data register does not automatically update the DAC output. Instead, the update occurs only after an LDAC trigger occurs. An LDAC trigger is generated either through a high-to-low transition on the LDAC pin in which case all 96 DACs update at the same time or by the self-clearing LDAC bit in each of the four subsystems CON registers (address 0x4, bit 15) which enables synchronization of all the DACs in the selected subsystem.

After the DAC outputs have been configured, a clear event enables the DACs to be loaded with zero-code while retaining the previously programmed values, thus allowing the possibility to return to the voltage being output before the clear event was issued. Note that the DAC data registers can be updated while the device is in clear state allowing the DACs to output new values upon return to normal operation. When the device exits the clear state the DAC outputs are immediately loaded with the data in the DAC active registers.

The device is set into clear state through the  $\overline{\text{CLEAR}}$  pin. Setting the  $\overline{\text{CLEAR}}$  pin low forces all 96 DACs into clear state. Setting the  $\overline{\text{CLEAR}}$  pin back high returns all DACs to normal operation. Alternatively, the CLRDAC bits in each of the four subsystems CON registers (Address 0x4, bits [5:4]) can be used to enter or exit clear state at a subsystem level.

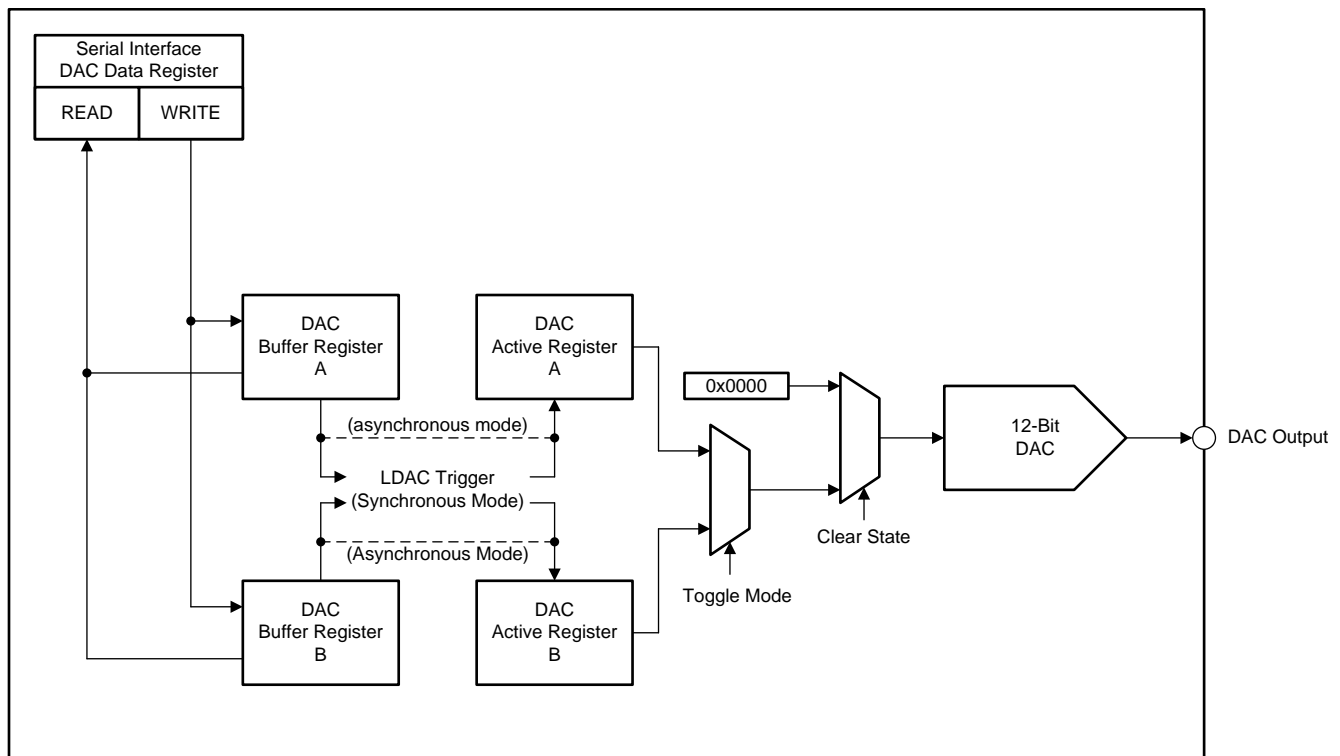

**Figure 33. DAC60096 DAC Block Diagram**

### 7.3.2 Reference Specifications

The DAC60096 integrates dedicated reference buffers that enable operation from an external 2.5-V reference source. The reference buffers generate the  $\pm 10.5\text{-V}$  levels used to drive the DACs in the device. A 100-nF bypass capacitor should be placed between the REF[1,2] input pins and REFGND[1,2]. Additionally a compensation 100-nF bypass capacitor for each VREFH\_n and VREFL\_n pin (n = G1, G2, G3, G4, G5, G6, G7 or G8) is required and should be placed as close as possible to the pins.

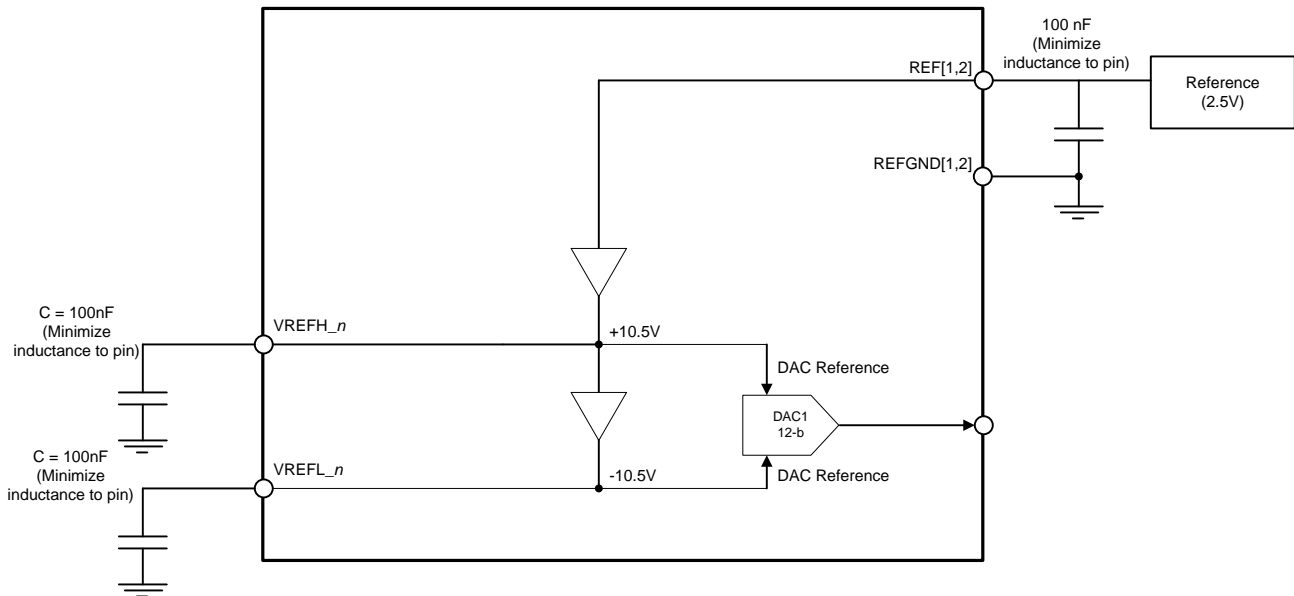

**Figure 34. Reference Operation**

## 7.4 Device Functional Modes

### 7.4.1 Toggle Mode

Each DAC in the device incorporates two DAC registers: Register A and Register B. The TRIGG pin is used to switch the DAC outputs back and forth between the contents of the two DAC specific registers. The DAC registers are prepared for trigger mode operation on a TRIGG rising edge and the outputs are toggled on each following high-to-low transition. This feature enables the generation of 96 amplitude independent square-waves.

The device incorporates an auto-populate feature that simplifies register configuration in toggle mode. Auto-populate is enabled by the APB bits in the CON register (address 0x4, bits [1:0]). When auto-populate is enabled, a Register A update automatically loads Register B with the negative value of the data written to A. Although the Register B data can be modified by a direct register write, this update does not auto-populate the Register A contents.

The STATS output pin is used to identify the active register. A logic-low is output for Register A and logic-high for register B. The STATS pin is in high impedance mode by default and must be enabled by the SDRV bits in the CON register for subsystem 1 (address 0x4, bits [9:8]). The SDRV bits in the other three subsystems should be set to high impedance mode (default mode). The toggling rate of the STATS terminal is determined by the SDIV register (address 0x9). The SDIV register should only be updated after a device reset and before configuring the DAC outputs. The STATS output pin toggles on every  $2^{\text{SDIV}}$  trigger pulse (SDIV = 0, 1, ..., 6).

### 7.4.2 DC Mode

A fixed TRIGG pin puts the device in DC mode operation. In DC mode only one of the two DAC data registers is used to control the DAC output. If no TRIGG rising edge is detected by the device after power-up, Register A is by default the active register.

### 7.5 Programming

The DAC60096 is controlled through a flexible four-wire serial interface that is compatible with SPI type interfaces used on many microcontrollers and DSP controllers. The interface provides read/write access to all registers of the DAC60096.

For simplification of the register structure, communication to the device is done at a subsystem level through the PTR global pointer register (address 0x6). Subsystem addressing is done through SID[1:0], where subsystem 1 is the default setting. Access to all other registers in the device will affect only the subsystem selected by SID. The DAC pointer setting, DPTR[4:0], also in the PTR register allows access to the data registers (BUFA and BUFB) for any of the DACs in the chosen subsystem.

Each serial interface access cycle is exactly 24 bits long. A frame is initiated by asserting the  $\overline{CS}$  pin low. The frame ends when the  $\overline{CS}$  pin is deasserted high. The frame's first byte input to SDI is the instruction cycle which identifies the request as a read or write, streaming or single, and the 4-bit address to be accessed. The following bits in the frame form the data cycle. For all writes, data are clocked on the rising edge of SCLK. On read access, data are clocked out on the SDO pin on either the falling edge or rising edge of SCLK according to the PHAINV setting in each of the four subsystems CON registers (address 0x4, bits [7:6]).

Table 2. Serial Interface Cycle

Bit	Field	Description
23	R/W	Identifies the communication as a read or write command to the addressed register. R/W = 0 sets a write operation. R/W = 1 sets a read operation.
22	S	Identifies the communication as a streaming operation. S = 0 is used for single command instructions. Bit = 1 is used for streaming operation.
21:18	A[3:0]	Register address. Specifies the register to be accessed during the read or write operation.
17:16	Reserved	Reserved. Set to zeros for proper operation.
15:0	D[15:0]	Data cycle bits. If a write command, the data cycle bits are the values to be written to the register with address A[3:0] If a read command, the data cycle bits are <i>don't care</i> values.

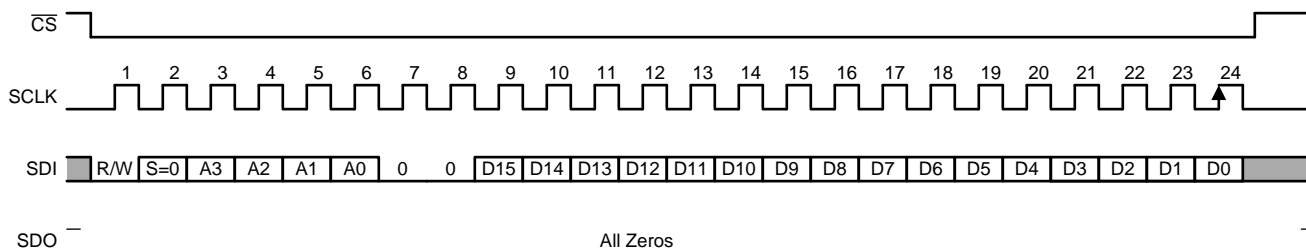

Figure 35. Serial Interface Write Bus Cycle

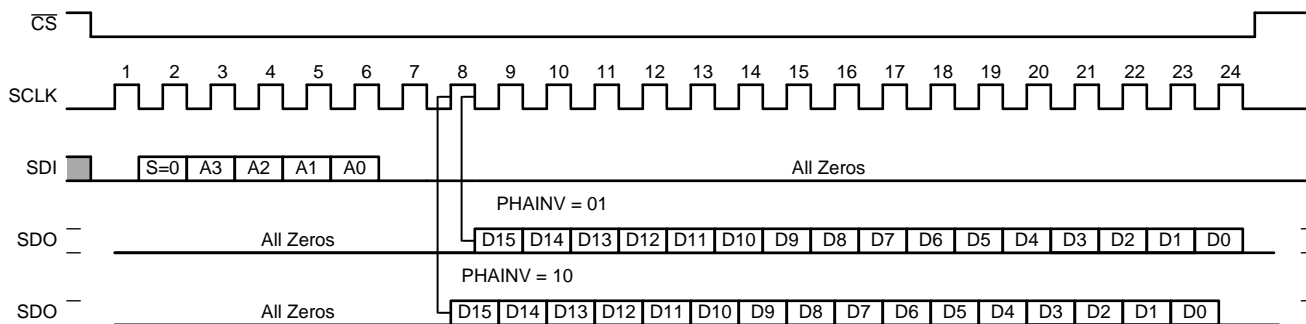
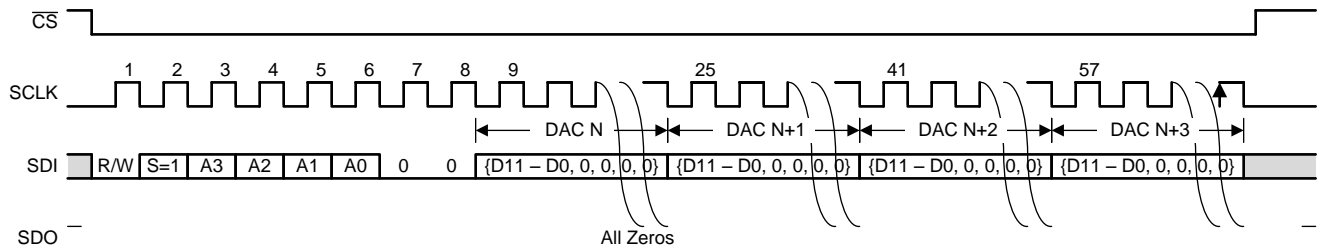

Figure 36. Serial Interface Read Bus Cycle

In order to simplify write or read operations to multiple DACs in a subsystem, streaming mode is supported. In streaming mode, multiple bytes of data can be written to or read from the DAC60096 without specifically providing instructions for each byte and is implemented by continually holding the  $\overline{CS}$  pin active and continuing to shift new data in or old data out of the device.

The DAC60096 starts reading or writing data to the DAC data register selected by the PTR register and automatically increments the DAC pointer (DPTR) as long as the  $\overline{CS}$  pin is asserted. If the last DAC in the chosen subsystem has been reached and the  $\overline{CS}$  pin is still asserted, the data register for this DAC will be overwritten with the new data.



**Figure 37. Serial Interface Streaming Write Cycle**

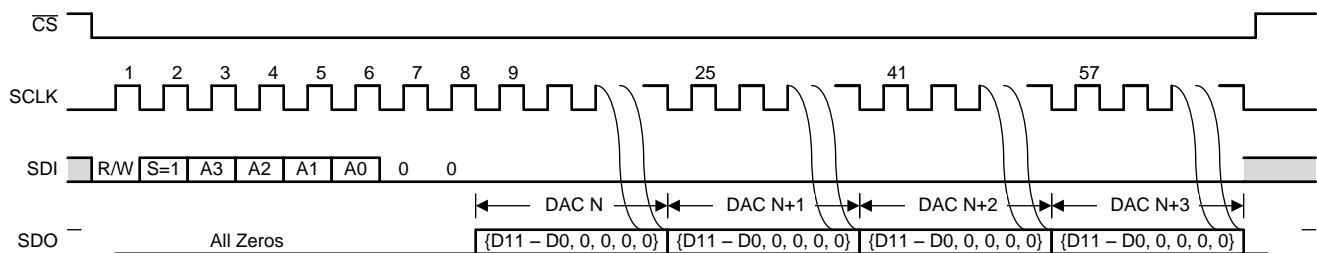

**Figure 38. Serial Interface Streaming Read Cycle**

### 7.5.1 Frame Error Checking

If the DAC60096 is used in a noisy environment, error checking can be used to check the integrity of the serial interface data communication between the device and the host processor. The frame error checking scheme is based on the CRC-CCITT-16 polynomial  $x^{16} + x^{12} + x^5 + 1$  (that is, 0x1021). The CRC register (address 0x5) stores the CRC computation for each single-command or streaming serial interface data write. Reading the CRC register resets its contents to 0xFFFF.

Only valid data cycles are included in the CRC computation. For single-command instructions CRC is calculated and updated only after 16 data bits are received. If a data cycle is longer than 16 bits, the additional bits are not included into the CRC calculation. For streaming commands CRC is calculated and updated on the multiple 16-bit data cycles received. If the number of data bits received is not a multiple of 16, the modulo 16 bits are discarded from the CRC calculation.



### 7.6 Register Maps

Communication to the DAC60096 is done at a subsystem level. Subsystem addressing is done through the global pointer register, SID[1:0]. Each subsystem has 16 registers. Access to the data registers of any of the DACs in the chosen subsystem is done through a DAC pointer, DPTR[4:0].

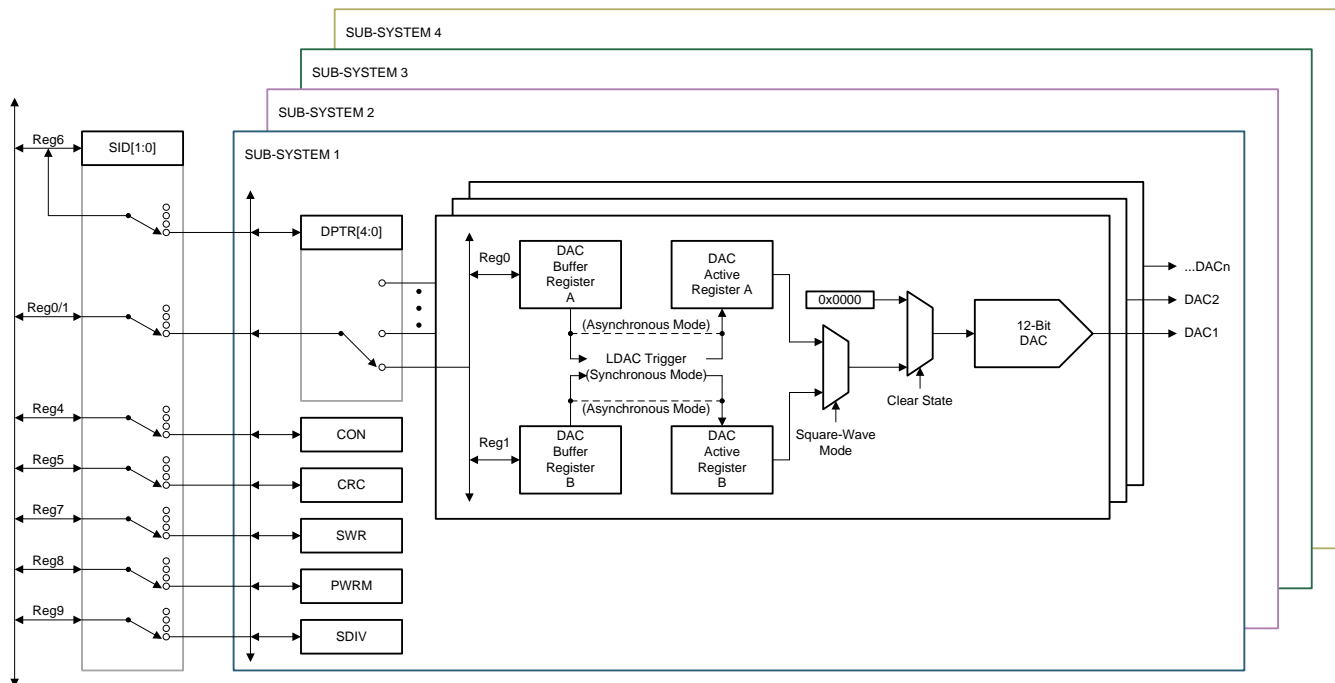

Figure 39. Register Configuration

Table 3. Register Map

REGISTER	TYPE	RESET	ADDRESS				REGISTER SETUP																			
			A3	A2	A1	A0	D15	D14	D13	D12	D11	D10	D9	D8	D7	D6	D5	D4	D3	D2	D1	D0				
BUFA	R/W	0000	0	0	0	0	BUFA																0	0	0	0
BUFB	R/W	0000	0	0	0	1	BUFB																0	0	0	0
RESERVED	--	0000	0	0	1	0	0	0	0	0	0	0	0	0	0	0	0	0	0	0	0	0				
RESERVED	--	0000	0	0	1	1	0	0	0	0	0	0	0	0	0	0	0	0	0	0	0	0				
CON	R/W	0555	0	1	0	0	LDAC	0	0	0	SDO2x	SDRV	PHAINV	CLRDAC	0	1	APB									
CRC	R	FFFF	0	1	0	1	CRC																			
PTR	R	0000	0	1	1	0	0	0	SID	0	0	0	0	0	0	0	DPTR									
SWR	R/W	0000	0	1	1	1	SWR																			
PWRM	R/W	CAFE	1	0	0	0	PWRM																			
SDIV	R/W	0000	1	0	0	1	0	0	0	0	0	0	0	0	0	0	0	0	0	0	0	SDIV				
RESERVED	--	0000	0xA – 0xF				-----																			

**7.6.1 8.5.1 BUFA Register (address = 0x0) [reset = 0x0000]**

**Figure 40. BUFA Register**

15	14	13	12	11	10	9	8
BUFA							
R/W							
7	6	5	4	3	2	1	0
BUFA				RESERVED			
R/W				R/W			

LEGEND: R/W = Read/Write; R = Read only; -n = value after reset

**Table 4. BUFA Register**

Bit	Field	Type	Reset	Description
15:4	BUFA	R/W	0000	Double-buffer MSB aligned 12-bit data for DAC register A. The specific DAC accessed by this register must be first set by the subsystem address (SID) and DAC pointer (DPTR).
3:0	Reserved	R/W	0000	Not used

**7.6.2 BUFB Register (address = 0x1) [reset = 0x0000]**

**Figure 41. BUFB Register**

15	14	13	12	11	10	9	8
BUFB							
R/W							
7	6	5	4	3	2	1	0
BUFB				Reserved			
R/W				R/W			

LEGEND: R/W = Read/Write; R = Read only; -n = value after reset

**Table 5. BUFB Register**

Bit	Field	Type	Reset	Description
15:4	BUFB	R/W	0000	Double-buffer MSB aligned 12-bit data for DAC register B. The specific DAC accessed by this register must be first set by the subsystem address (SID) and DAC pointer (DPTR).
3:0	Reserved	R/W	0000	Not used

**7.6.3 CON Register (address = 0x4) [reset = 0x0555]**
**Figure 42. CON Register**

15	14	13	12	11	10	9	8
LDAC	Reserved			SDO2x[1:0]		SDRV[1:0]	
R/W	R/W			R/W		R/W	
7	6	5	4	3	2	1	0
PHAINV[1:0]		CLRDAC[1:0]		Reserved		APB[1:0]	
R/W		R/W		R/W		R/W	

LEGEND: R/W = Read/Write; R = Read only; -n = value after reset

**Table 6. CON Register**

Bit	Field	Type	Reset	Description
15	LDAC	R/W	0	Setting this bit to 1 issues an LDAC trigger at $\overline{CS}$ rising edge. Self-clearing bit.
14:12	Reserved	R/W	000	Not used.
11:10	SDO2x[1:0]	R/W	01	SDO 1x/2x drive strength: 01: 1x (default) 10: 2x Writing 00 or 11 has no effect
9:8	SDRV[1:0]	R/W	01	SDRV control STATS pin drive type: 01: Hi-Z. STATS pin is disabled (default) 10: CMOS Push-pull output. Should only be enabled for subsystem 1. Writing 00 or 11 has no effect
7:6	PHAINV[1:0]	R/W	01	PHAINV controls SDO output edge: 01: SCLK NegEdge (default) 10: SCLK PosEdge Writing 00 or 11 has no effect
5:4	CLRDAC[1:0]	R/W	01	Clear DAC state control: 01: Normal operating state (default) 10: Clear DAC state Writing 00 or 11 has no effect
3:2	Reserved	R/W	01	Reserved for factory use
1:0	APB[1:0]	R/W	01	Auto populate B: 01: Auto-populates BUFB with the negative value of BUFA after each BUFA register write. Writing to BUFB has no auto-populate effect (default) 10: Disable auto populate B feature Writing 00 or 11 has no effect

7.6.4 CRC Register (address = 0x5) [reset = 0xFFFF]

Figure 43. CRC Register

15	14	13	12	11	10	9	8
CRC[15:0]							
R							
7	6	5	4	3	2	1	0
CRC[15:0]							
R							

LEGEND: R/W = Read/Write; R = Read only; -n = value after reset

Table 7. CRC Register

Bit	Field	Type	Reset	Description
15:0	CRC[15:0]	R	FFFF	Stores the CRC computation data for each SPI data write. CRC includes stream writes. The address byte is not included in the CRC computation. Reading Reg CRC resets current CRC value to 0xFFFF. CRC is calculated when $\overline{CS}$ is enabled and the data cycle contains a multiple of 16 bits. The redundant data are not written into the register. CRC-CCITT polynomial is used $x^{16} + x^{12} + x^5 + 1$ , or in hex: 0x1021 with default 0xFFFF.

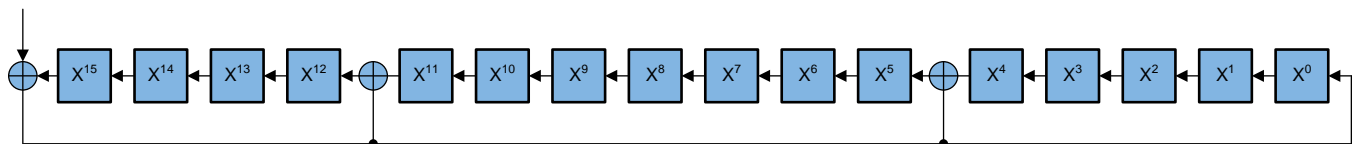

Figure 44. CRC CCITT 16

**7.6.5 PTR Register (address = 0x6) [reset = 0x0000]**
**Figure 45. PTR Register**

15	14	13	12	11	10	9	8
Reserved		SID[1:0]		Reserved			
R/W		R/W		R/W			
7	6	5	4	3	2	1	0
Reserved			DPTR[4:0]				
R/W			R/W				

LEGEND: R/W = Read/Write; R = Read only; -n = value after reset

**Table 8. PTR Register**

Bit	Field	Type	Reset	Description
15:14	Reserved	R/W	00	Reserved for factory use
13:12	SID[1:0]	R/W	00	Subsystem address: 00: Subsystem 1 01: Subsystem 2 10: Subsystem 3 11: Subsystem 4
11:8	Reserved	R/W	0000	Not used
7:5	Reserved	R/W	000	Reserved for factory use
4:0	DPTR[4:0]	R/W	0000	DAC pointer

**7.6.6 SWR Register (address = 0x7) [reset = 0x0000]**
**Figure 46. SWR Register**

15	14	13	12	11	10	9	8
SWR							
R/W							
7	6	5	4	3	2	1	0
SWR							
R/W							

LEGEND: R/W = Read/Write; R = Read only; -n = value after reset

**Table 9. SWR Register**

Bit	Field	Type	Reset	Description
15:0	SWR	R/W	0000	Writing 0xA5A5 to this register generates a software reset on the $\overline{CS}$ rising edge of the command for a subsystem. The software reset is similar to a hardware reset, which resets all registers and logic states. Reading this register gives the hardware version of the subsystem.

**7.6.7 PWRM Register (address = 0x6) [reset = 0xCAFE]**

**Figure 47. PWRM Register**

15	14	13	12	11	10	9	8
PWRM							
R/W							
7	6	5	4	3	2	1	0
PWRM							
R/W							

LEGEND: R/W = Read/Write; R = Read only; -n = value after reset

**Table 10. PWRM Register**

Bit	Field	Type	Reset	Description
15:0	PWRM	R/W	0000	<p>DV<sub>DD</sub> Power Monitor:                      After device power up, the PWRM register is 0xCAFE. Any register write to PWRM sets PWRM to 0xABBA. PWRM is reset to 0xCAFE after a DVDD collapse initiated POR event. Reading PWRM with value 0xCAFE indicates power failure or uninitialized value.                      The system controller can monitor PWRM to check for active power status. The device toggles the PWRM value after every PWRM register read. If the current read value is 0xABBA, the next read value will be 0xBAAB, and vice versa.                      The PWRM register only monitors DV<sub>DD</sub> power failure. AV<sub>CC</sub> is monitored by the analog reset circuit. When there is a power failure on AV<sub>CC</sub> all the DACs in the device go into clear state.</p>

**7.6.8 SDIV Register (address = 0x9) [reset = 0x0000]**

**Figure 48. SDIV Register**

15	14	13	12	11	10	9	8
Reserved							
R/W							
7	6	5	4	3	2	1	0
Reserved					SDIV		
R/W					R/W		

LEGEND: R/W = Read/Write; R = Read only; -n = value after reset

**Table 11. SDIV Register**

Bit	Field	Type	Reset	Description
15:3	Reserved	R/W	0000	Not Used
2:0	SDIV	R/W	000	<p>Status signal toggle rate:                      STATS pin toggling rate is controlled by SDIV register. SDIV is valid between 0 and 6. The STATS pin toggles on every 2<sup>SDIV</sup> trigger pulse.                      The SDIV setting should only be updated after a device reset and before configuring the DAC outputs.</p>

## 8 Application and Implementation

---

### NOTE

Information in the following applications sections is not part of the TI component specification, and TI does not warrant its accuracy or completeness. TI's customers are responsible for determining suitability of components for their purposes. Customers should validate and test their design implementation to confirm system functionality.

---

### 8.1 Application Information

The DAC60096 is a low-power, 96-channel, 12-bit, digital-to-analog converter (DAC). The device provides unbuffered bipolar voltage outputs up to  $\pm 10.5$  V.

This device is suitable for many applications involving multichannel bipolar DACs. Such applications include multichannel variable optical attenuators, MEMS mirror control, and ATE level drivers.

DAC60096

SBAS721A –DECEMBER 2015–REVISED JANUARY 2016

www.ti.com

8.2 Typical Application

An example schematic incorporating the DAC60096 device is shown in Figure 49.

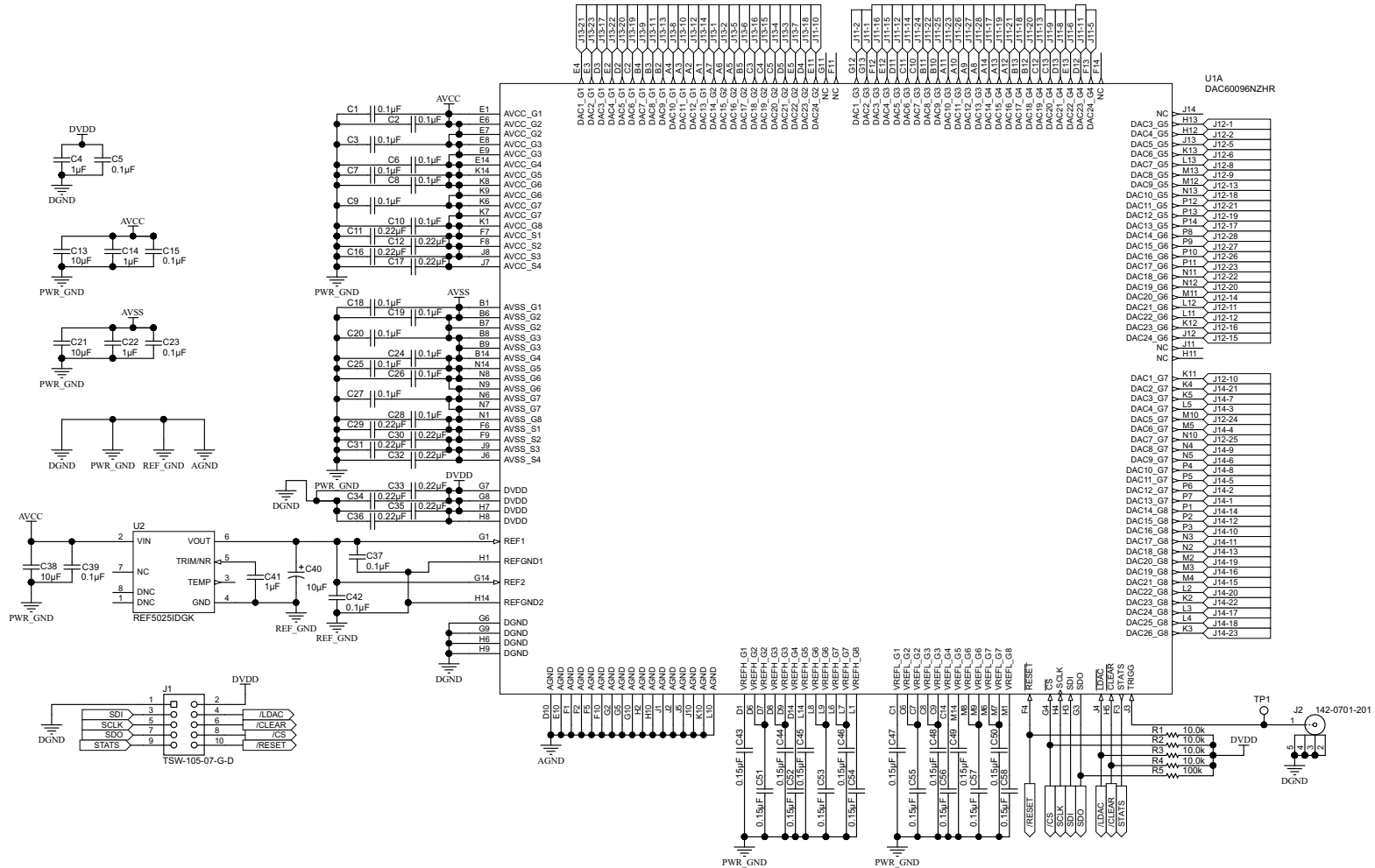

Figure 49. Example Schematic



## 8.2.1 Design Requirements

Figure 49 uses the parameters shown in Table 12.

Table 12. Design Parameters

PARAMETER	VALUE
AV <sub>CC</sub>	12 V
DV <sub>DD</sub>	5 V
AV <sub>SS</sub>	-12 V
REF1	2.5 V
REF2	2.5 V

## 8.2.2 Detailed Design Procedure

The following sections display components and applications that may facilitate the design process.

### 8.2.2.1 Power-Supply Bypassing

For accurate, high-resolution performance, all power supply pins should be bypassed to ground with low ESR ceramic bypass capacitors. For additional noise filtering, use a 10- $\mu$ F capacitor in parallel with a 0.1- $\mu$ F capacitor.

### 8.2.2.2 Reference Input

The internal reference buffers of the DAC60096 device require an external 2.5-V reference voltage source, which can be driven externally through a precision voltage source or generated from a high precision voltage IC. One such integrated circuit is the REF5025, which is a low-noise, low-drift, high precision voltage reference. The basic connections are listed in Figure 50. A supply bypass capacitor ranging between 1  $\mu$ F to 10  $\mu$ F is recommended. A 1- $\mu$ F to 50- $\mu$ F output capacitor must be connected from V<sub>OUT</sub> to GND. The ESR value of the output capacitor must be less than or equal to 1.5  $\Omega$  to ensure output stability. To help minimize noise, an additional 1- $\mu$ F capacitor is connected from TRIM/NR to GND.

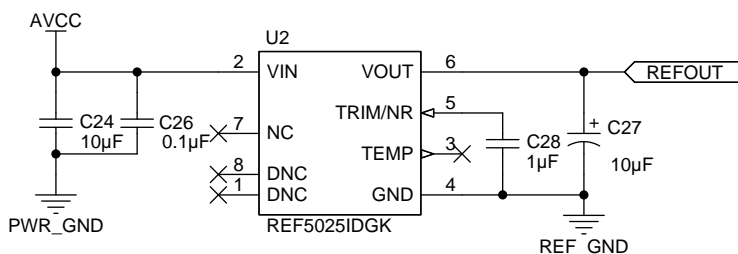

Figure 50. External Reference

### 8.2.2.3 TRIGG/Signal Conditioning

The TRIGG input signal provides the square waveform required for the DAC60096 device to operate as a square-wave generator. The DAC registers are prepared for square wave operation on a TRIGG rising edge and the outputs toggle on the falling edge. The [Timing Requirements<sup>\(1\)\(2\)</sup>](#) table specifies the timing parameters required for proper operation.

The TRIGG input signal can be supplied from a waveform generator or voltage-to-frequency converter. An example device with schematic is provided in Figure 51. The device highlighted is the LM231, a precision voltage-to-frequency converter with wide range of full-scale frequency (1 Hz to 100 kHz). In Figure 51 the device is configured to display 0.05% linearity over an output frequency range of 10 Hz to 4 kHz with an input range of 25 mV to 12.5 V. For more information, refer to the *Typical Applications* section of the LM231 datasheet (SNOSBI2).

(1) Specified by design and characterization. Not tested during production.

(2) SDO loaded with 10-pF load capacitance for SDO timing specifications.

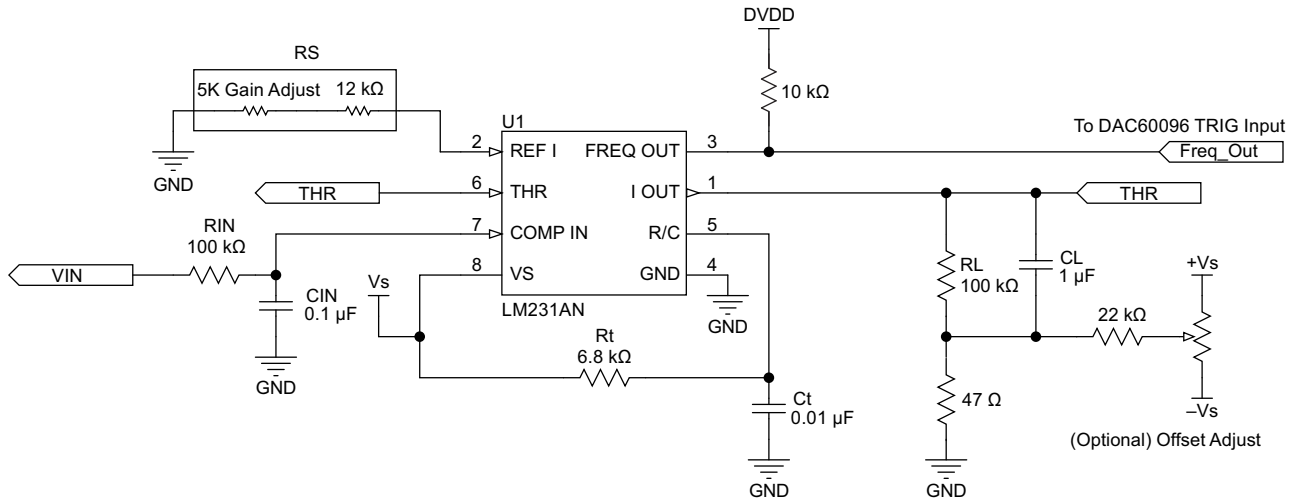

$$f_{out} = (VIN / 2.09 V) \times (RS / RL) \times (1 / (Rt \times Ct))$$

-All resistors 1% tolerance  
 -Caps with low dielectric absorption: NP0, C0G, polystyrene, and so on.

**Figure 51. External Precision Voltage-to-Frequency Converter for TRIGG Signal**

**8.2.2.4 External Amplifier Selection**

The outputs of the DAC60096 are unbuffered. The output impedance is specified as 41 kΩ. In applications requiring an external buffer, the selected amplifier should exhibit both low-offset voltage and input bias current. The input bias current of the amplifier creates a potential across the DAC output impedance. This voltage error is equivalent to the input bias current multiplied by the DAC output impedance value. For fast settling, the slew rate of the operational amplifier should not impede the settling time of the DAC. Output impedance of the DAC is constant and code-independent, but in order to minimize gain errors the input impedance of the output amplifier should be as high as possible. Additionally, the amplifier adds another time constant, which increases the settling time response of the system. A higher 3-dB bandwidth amplifier effectively shortens the settling time, and additionally increases the bandwidth of the system.

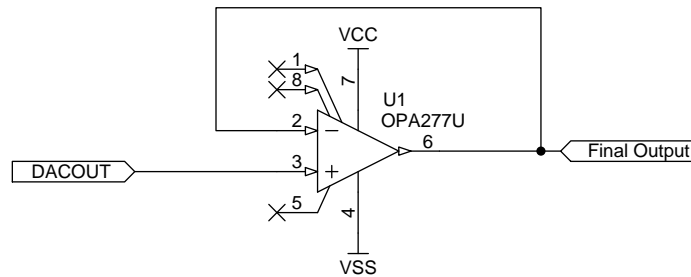

**Figure 52. DAC Output With External Amplifier in Voltage-Follower Configuration**

**8.2.2.5 Unbuffered Settling Response**

For applications that use the unbuffered output, the typical settling response for different capacitive loads is displayed in [Figure 53](#).

### 8.2.3 Application Curves

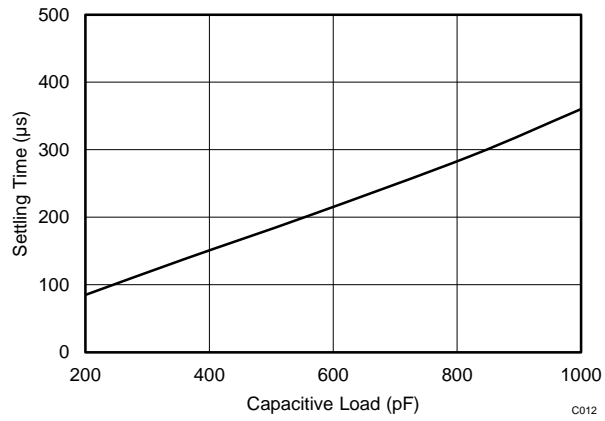

Figure 53. DAC Settling Time vs Capacitive Load

## 9 Power Supply Recommendations

It is highly recommended that  $AV_{CC}$  is supplied prior to  $AV_{SS}$ .  $DV_{DD}$  sequencing is not critical. The recommended sequence is  $AV_{CC}$  followed by  $AV_{SS}$  with  $DV_{DD}$  and the REF[1,2] inputs applied last.

**Table 13. Input-Voltage Recommendations**

		MIN	TYP	MAX	UNIT	
Supply voltage	$AV_{CC}$	11.2	12	12.6	V	
	$AV_{SS}$	-12.6	-12	-11.2	V	
	$DV_{DD}$	3	3.3	5.5	V	
	$AV_{CC}$ to $AV_{SS}$	22.4	24	25.2	V	
<b>EXTERNAL REFERENCE INPUTS</b>						
$V_{REF}$	Reference input voltage	REF1 and REF2 input pins	2.475	2.5	2.525	V

### 9.1 Device Reset Options

#### 9.1.1 Power-on-Reset (POR)

The DAC60096 includes a power-on reset function. After the  $DV_{DD}$  supply has been established a POR event is issued. The POR causes all registers to initialize to their default values and communication with the device is valid only after a 250  $\mu$ s power-on-reset delay. The default value for all DACs is zero-code.

A power failure on  $DV_{DD}$  also results in a power-on-reset event. The PWRM register (address 0x8) can be used to monitor a  $DV_{DD}$  power failure. After power-up the PWRM register is set to 0xCAFE. Any register write to the PWRM register changes its contents to 0xABBA. If a PWRM register read returns 0xCAFE either the PWRM register has not been initialized or a  $DV_{DD}$  power failure has occurred.

The device also includes an  $AV_{CC}$  power failure detection circuit. In contrast to a  $DV_{DD}$  power failure, a collapse in  $AV_{CC}$  does not result in a reset event. An  $AV_{CC}$  power failure forces all DACs to go into clear state but does not reset the DAC data register values which enables the device to return to normal operation once  $AV_{CC}$  recovers. Even though the DACs are loaded with zero-code during an  $AV_{CC}$  power failure, it is important to note that this does not necessarily indicate the DAC outputs will be at 0 V due to  $AV_{CC}$  being outside of its supply voltage range.

As long as  $DV_{DD}$  and  $AV_{CC}$  remain above their specified high threshold a power failure event will not occur. In order to ensure a  $DV_{DD}$  or  $AV_{CC}$  collapse is registered as such by the device, these supplies must be below their corresponding low threshold for at least 1 ms. When the supplies drop below their high threshold but remain over the lower one (shown as the undefined region of [Figure 54](#) and [Figure 55](#)), the device may or may not reset ( $DV_{DD}$ ) or go into clear state ( $AV_{CC}$ ) under all specified temperature and power-supply conditions.

Device Reset Options (continued)

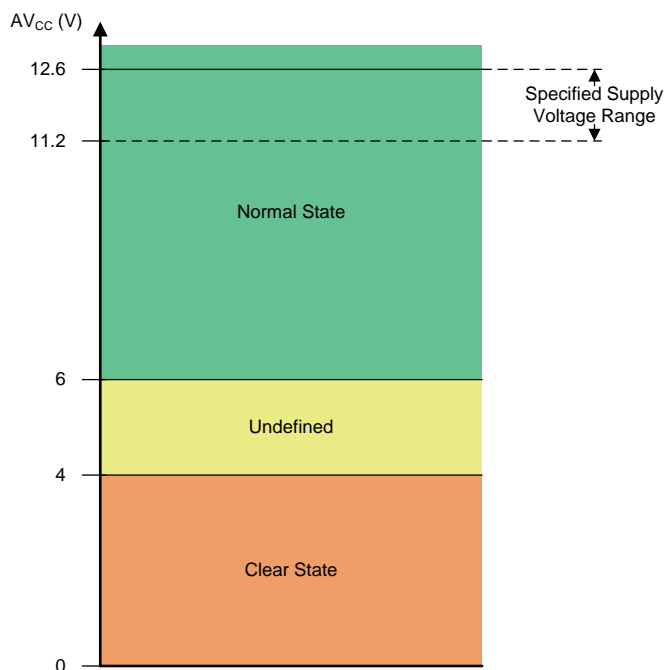
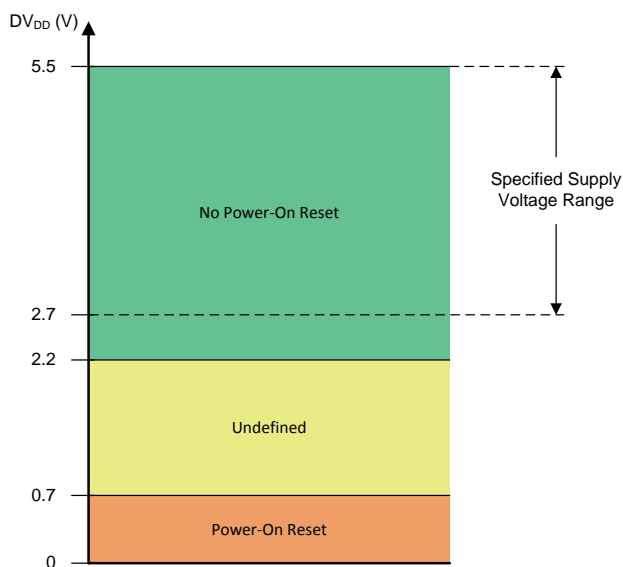

Figure 54. Threshold Levels for DV<sub>DD</sub> POR Circuit

Figure 55. Threshold Levels for AV<sub>CC</sub> Clear Circuit

9.1.2 Hardware Reset

A device hardware reset event is initiated by a minimum 500 ns logic low on the  $\overline{\text{RESET}}$  pin. A hardware reset causes all registers to initialize to their default values and communication with the device is valid only after a 50  $\mu\text{s}$  reset delay. The default value for all DACs is zero-code.

9.1.3 Software Reset

A subsystem software reset event is initiated by writing 0xA5A5 to the  $\overline{\text{SWR}}$  register (address 0x7) for that particular subsystem. The software reset command is triggered on the  $\overline{\text{CS}}$  rising edge of the instruction. As with the hardware reset, a software reset causes all registers to initialize to their default values and communication with the device is valid only after a 50  $\mu\text{s}$ . Note, however, that the reset only applies to the subsystem being addressed during the command. In order to reset the entire device as a hardware reset does, a software reset command should be issued to each of the four subsystems in the device.

## 10 Layout

### 10.1 Layout Guidelines

- Bypass all power-supply pins to ground with a low ESR ceramic bypass capacitor. The typical recommended bypass capacitance is 0.1- $\mu$ F to 0.22- $\mu$ F ceramic with a X7R or NP0 dielectric.
- Place power supplies and VREFH/L bypass capacitors close to pins to minimize inductance and optimize performance. Inner supply and reference pads can connect to the bypass arrangement on the bottom layer of the PCB through vias to minimize trace length. This is illustrated in [Figure 56](#) and [Figure 59](#).
- Include a 100-nF bypass capacitor for both internal reference inputs between this pin and their respective ground pins.
- Use a high-quality ceramic type NP0 or X7R for optimal performance across temperature, and low dissipation factor.
- Make sure that the digital and analog sections have proper placement with respect to the digital pins and analog pins of the DAC60096 device. The separation of analog and digital blocks allow for better design and practice because it reduces coupling into neighboring blocks, and minimizes the interaction between analog and digital return currents.

### 10.2 Layout Examples

#### 10.2.1 Optimal Layout Example

Optimal layout requires the addition of blind vias. This layout reduces trace length and brings the bypass capacitor arrangements closer to the device pads. [Figure 56](#) to [Figure 59](#) show the board layouts.

Layout Examples (continued)

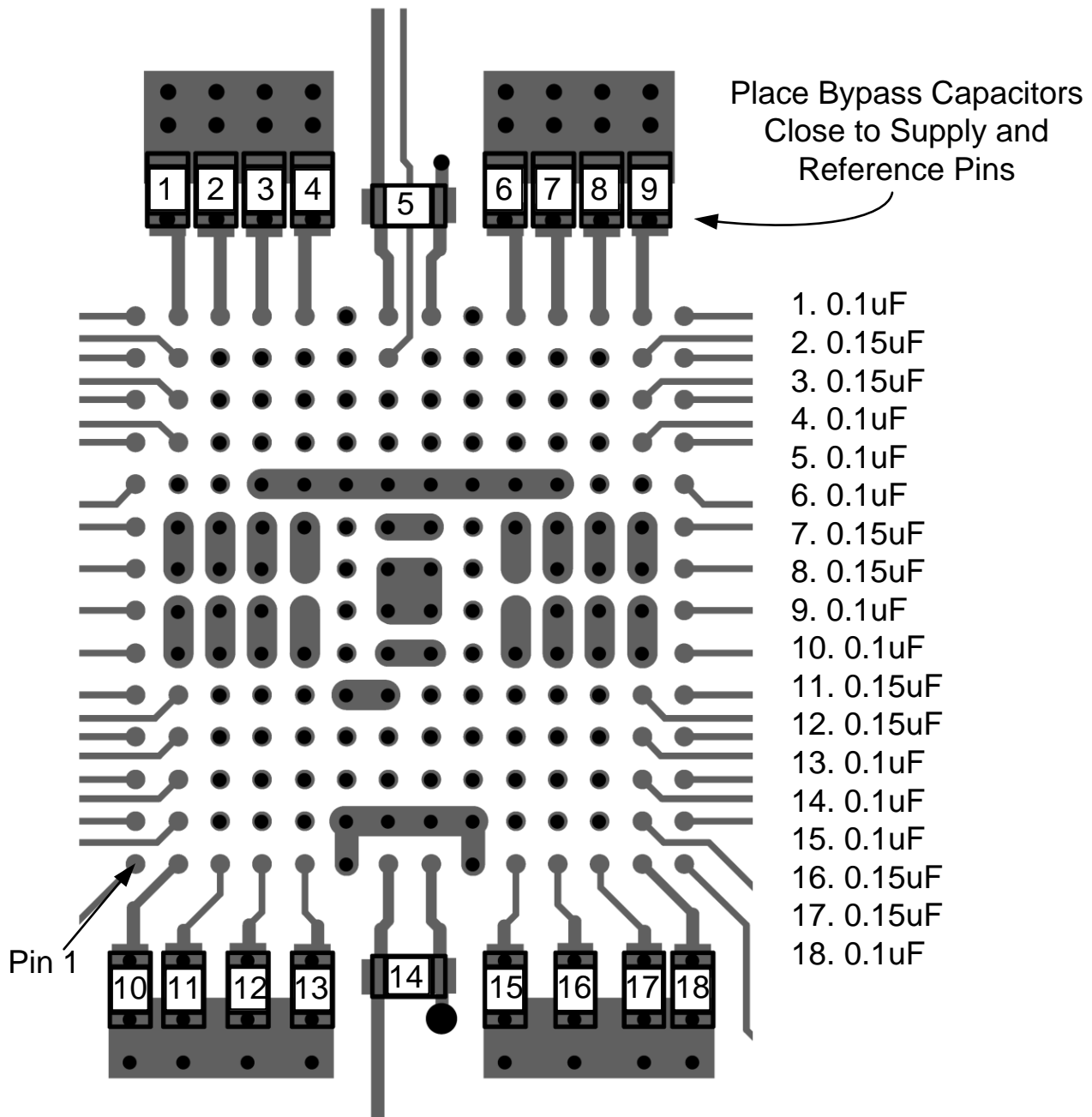
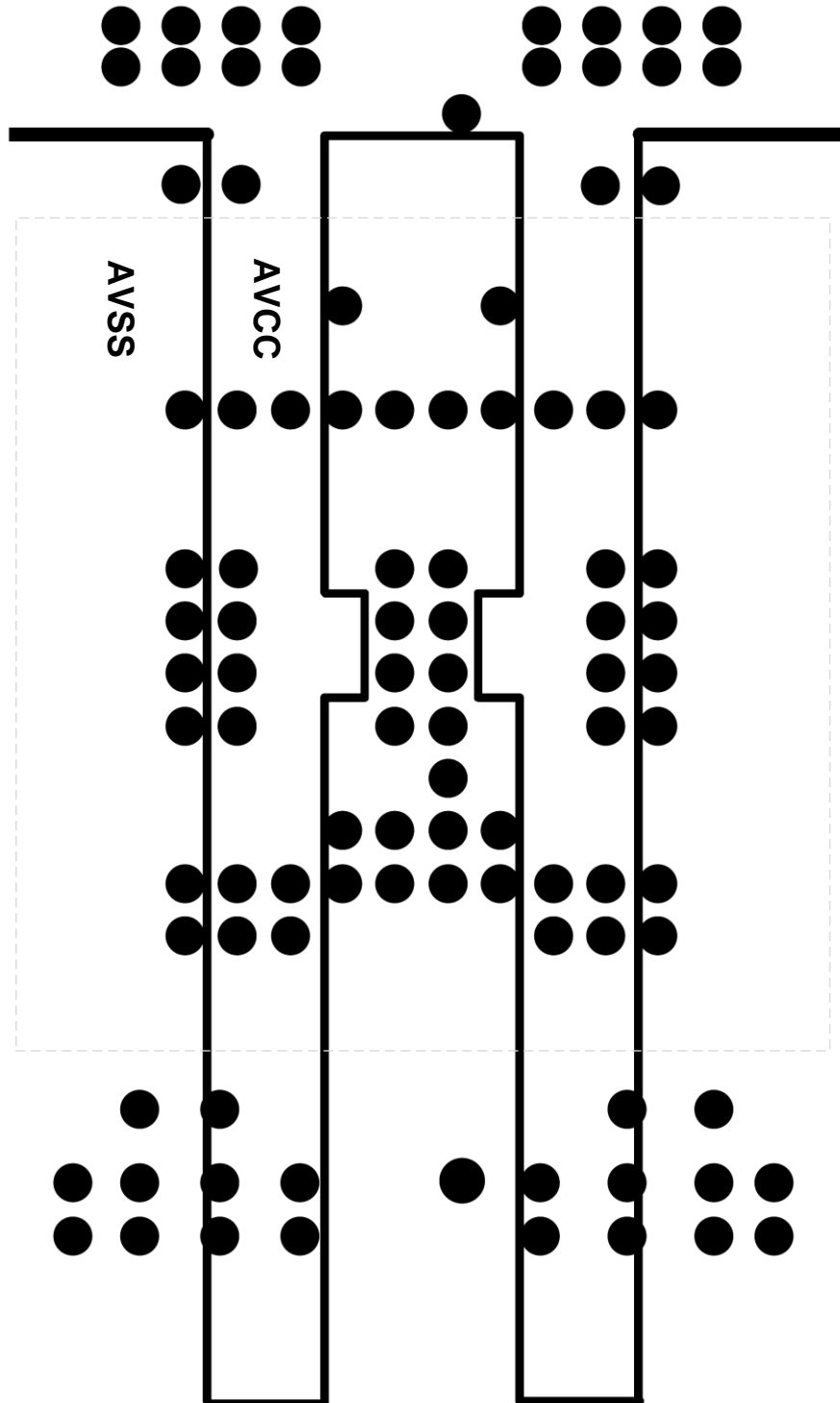

Figure 56. DAC60096 Example Board Layout – Top Layer PCB

**Layout Examples (continued)**



**Figure 57. DAC60096 Example Board Layout – Internal AVCC and AVSS Plane**



Layout Examples (continued)

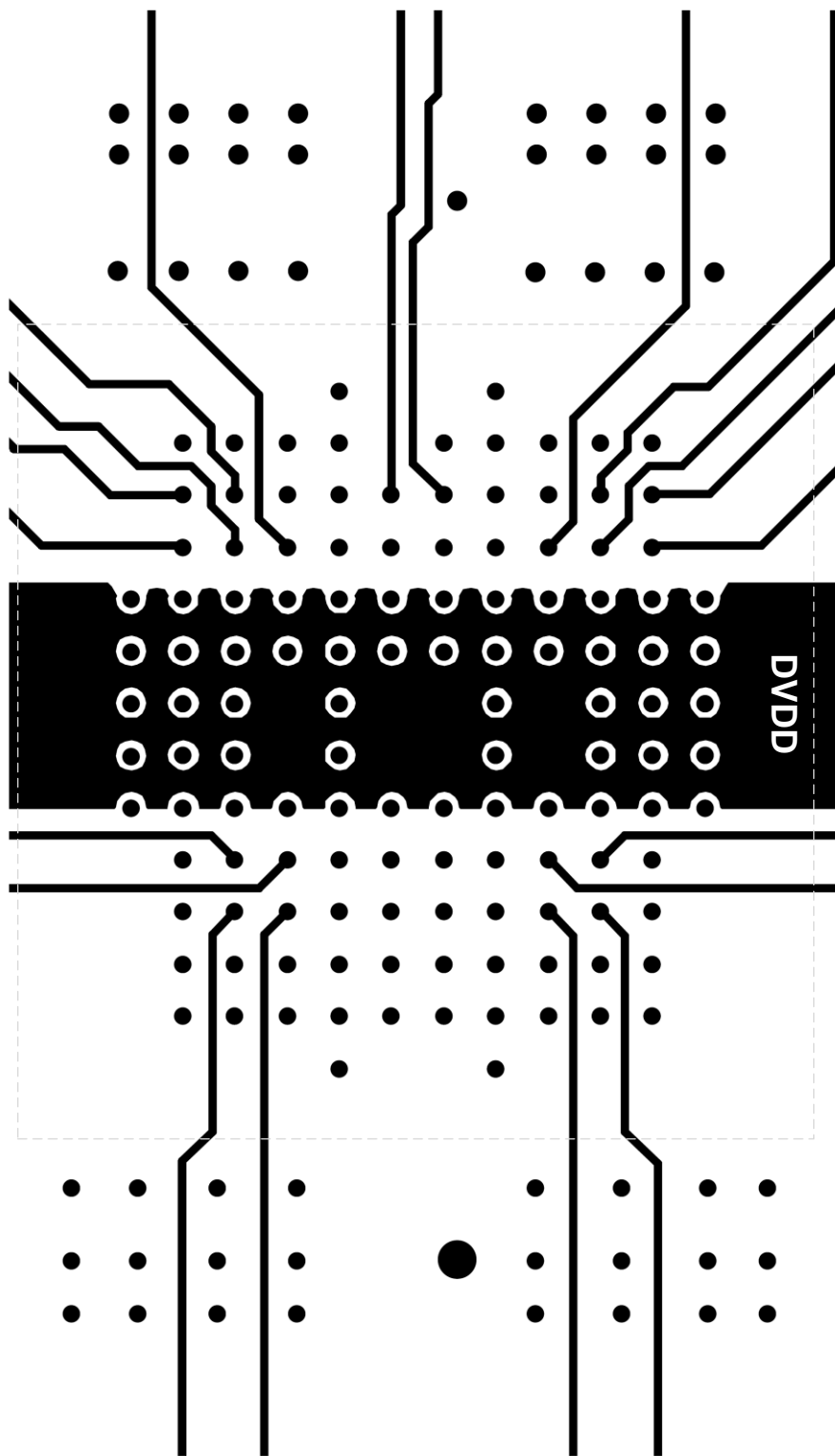
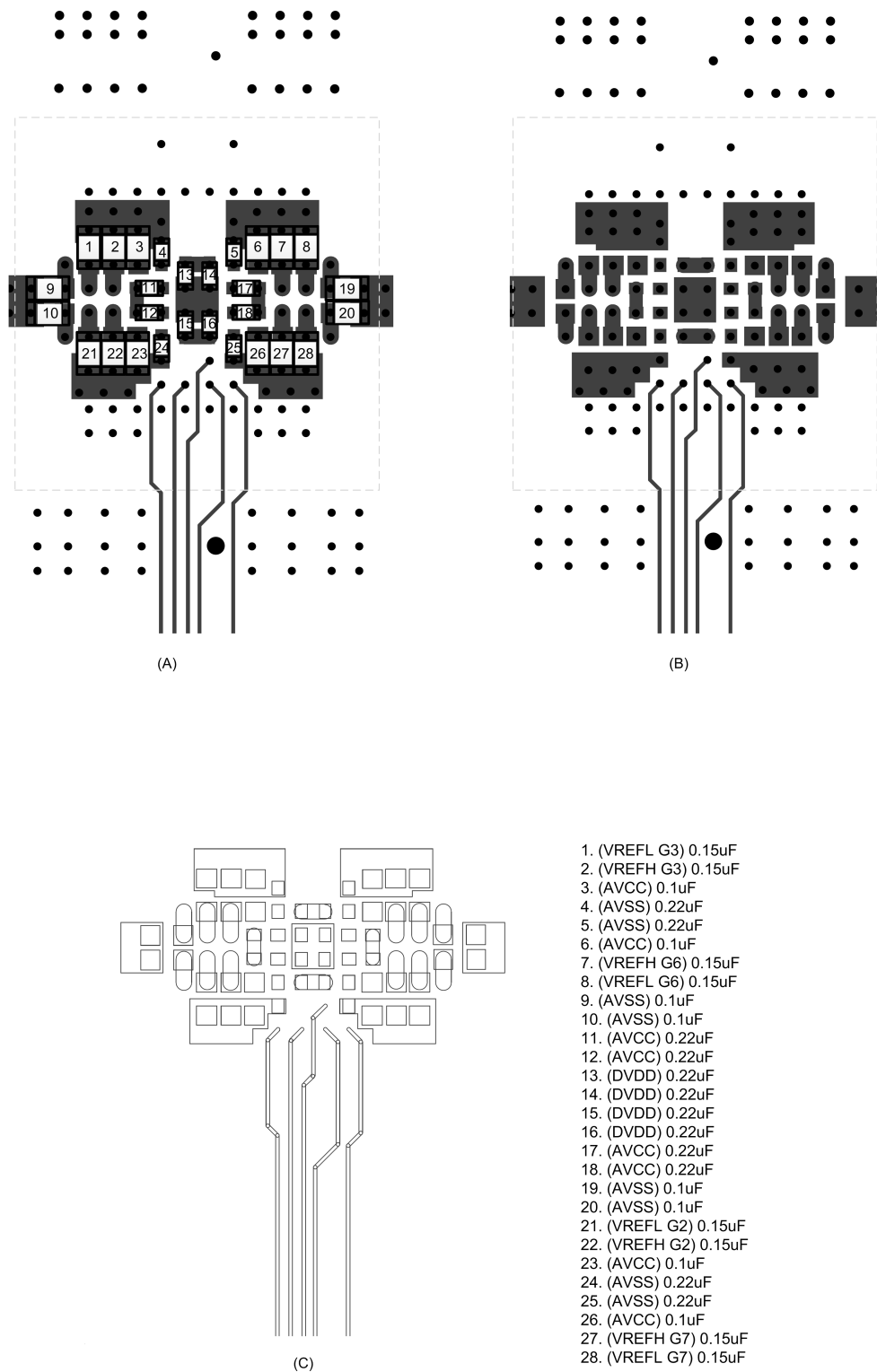

Figure 58. DAC60096 Example Board Layout – DVDD Internal Plane With Select DAC Outputs

**Layout Examples (continued)**

**Figure 59. DAC60096 Example Board Layout – Bottom Layer PCB.**  
**(A): Bypass Capacitor Arrangement; (B) Polygon Pours; (C) PAD With Pours**

## Layout Examples (continued)

### 10.2.2 Standard Layout Example

Only through-hole vias are included in this layout. Bypass capacitors are placed as close to their respective device pads. Bottom bypass brought out from device. This layout can lead to increased trace length, which will increase the series inductance of the net making it more susceptible to noise and voltage spikes. [Figure 60](#) to [Figure 61](#) show the board layouts.

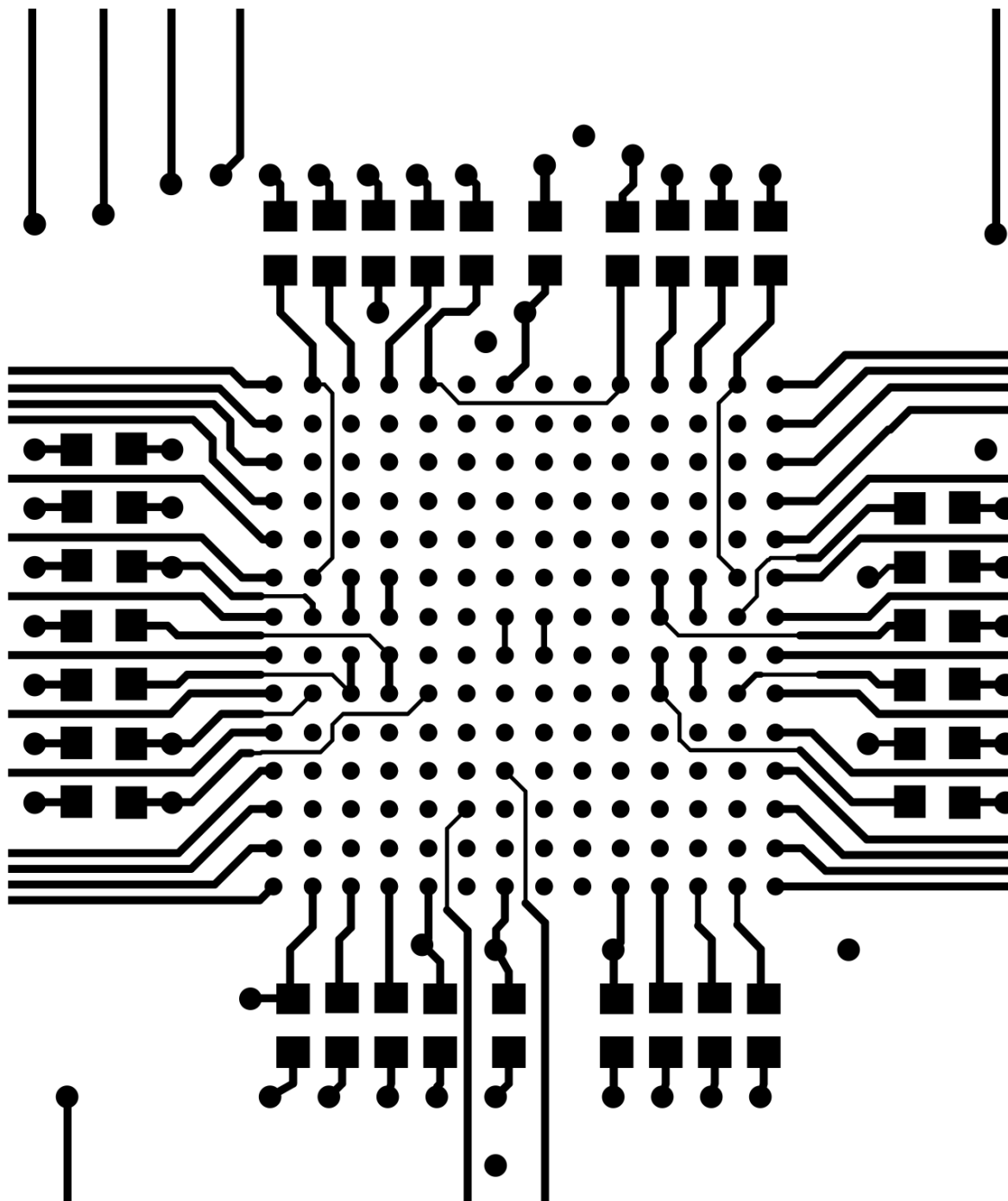

Figure 60. DAC60096 Example Board Layout – Top Layer

Layout Examples (continued)

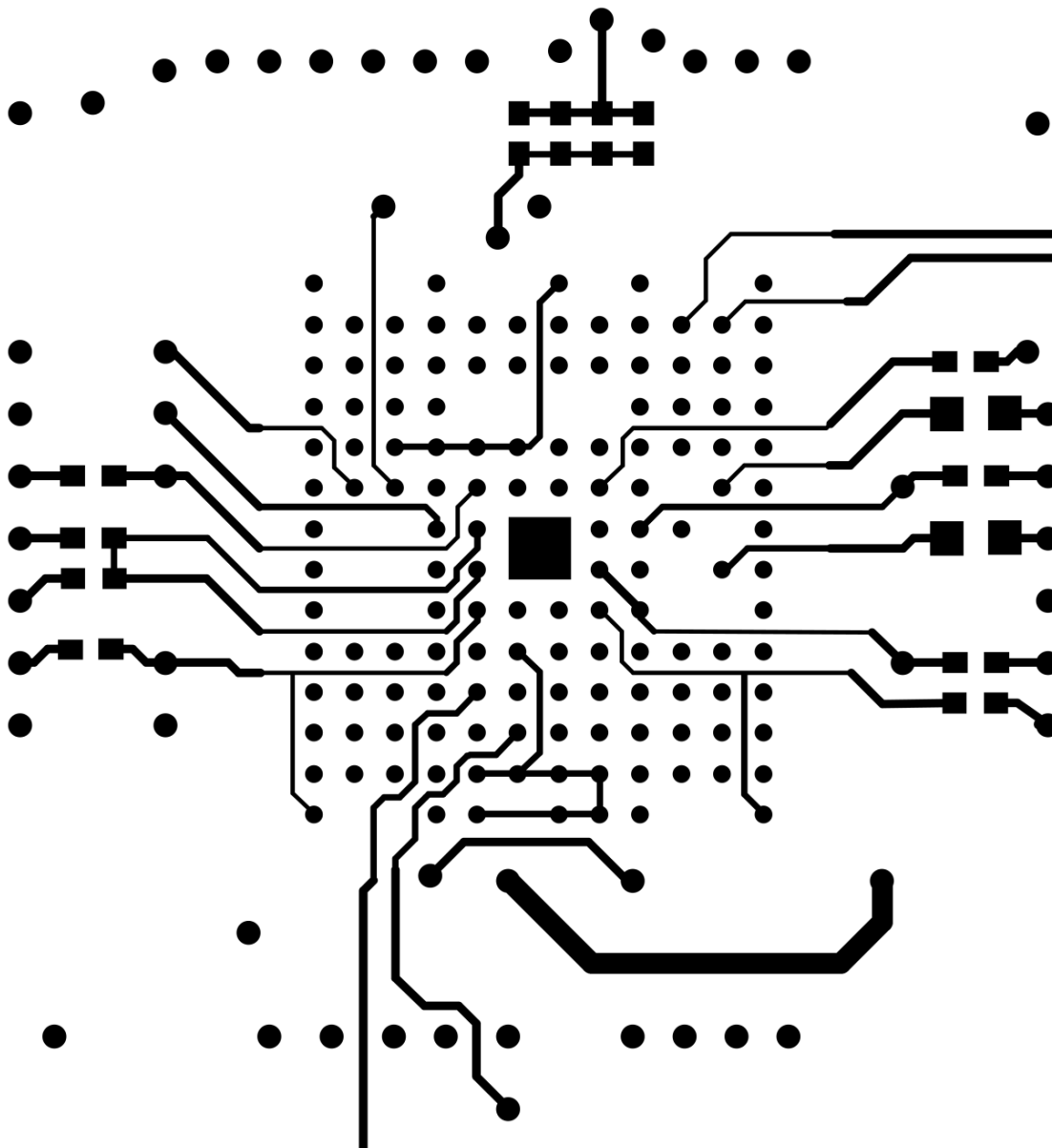

Figure 61. DAC60096 Example Board Layout – Bottom Layer

## 11 Device and Documentation Support

### 11.1 Documentation Support

#### 11.1.1 Related Documentation

[LM231](#) datasheet, [SNOSBI2](#)

### 11.2 Community Resources

The following links connect to TI community resources. Linked contents are provided "AS IS" by the respective contributors. They do not constitute TI specifications and do not necessarily reflect TI's views; see TI's [Terms of Use](#).

**TI E2E™ Online Community** *TI's Engineer-to-Engineer (E2E) Community*. Created to foster collaboration among engineers. At [e2e.ti.com](#), you can ask questions, share knowledge, explore ideas and help solve problems with fellow engineers.

**Design Support** *TI's Design Support* Quickly find helpful E2E forums along with design support tools and contact information for technical support.

### 11.3 Trademarks

E2E is a trademark of Texas Instruments.

SPI is a trademark of Motorola Inc.

All other trademarks are the property of their respective owners.

### 11.4 Electrostatic Discharge Caution



This integrated circuit can be damaged by ESD. Texas Instruments recommends that all integrated circuits be handled with appropriate precautions. Failure to observe proper handling and installation procedures can cause damage.

ESD damage can range from subtle performance degradation to complete device failure. Precision integrated circuits may be more susceptible to damage because very small parametric changes could cause the device not to meet its published specifications.

### 11.5 Glossary

[SLYZ022](#) — *TI Glossary*.

This glossary lists and explains terms, acronyms, and definitions.

## 12 Mechanical, Packaging, and Orderable Information

The following pages include mechanical, packaging, and orderable information. This information is the most current data available for the designated devices. This data is subject to change without notice and revision of this document. For browser-based versions of this data sheet, refer to the left-hand navigation.

**PACKAGING INFORMATION**

Orderable Device	Status (1)	Package Type	Package Drawing	Pins	Package Qty	Eco Plan (2)	Lead finish/ Ball material (6)	MSL Peak Temp (3)	Op Temp (°C)	Device Marking (4/5)	Samples
DAC60096IZEB	ACTIVE	NFBGA	ZEB	196	126	RoHS & Green	SNAGCU	Level-3-260C-168 HR	-40 to 85	DAC60096	Samples

(1) The marketing status values are defined as follows:

**ACTIVE:** Product device recommended for new designs.

**LIFEBUY:** TI has announced that the device will be discontinued, and a lifetime-buy period is in effect.

**NRND:** Not recommended for new designs. Device is in production to support existing customers, but TI does not recommend using this part in a new design.

**PREVIEW:** Device has been announced but is not in production. Samples may or may not be available.

**OBSOLETE:** TI has discontinued the production of the device.

(2) **RoHS:** TI defines "RoHS" to mean semiconductor products that are compliant with the current EU RoHS requirements for all 10 RoHS substances, including the requirement that RoHS substance do not exceed 0.1% by weight in homogeneous materials. Where designed to be soldered at high temperatures, "RoHS" products are suitable for use in specified lead-free processes. TI may reference these types of products as "Pb-Free".

**RoHS Exempt:** TI defines "RoHS Exempt" to mean products that contain lead but are compliant with EU RoHS pursuant to a specific EU RoHS exemption.

**Green:** TI defines "Green" to mean the content of Chlorine (Cl) and Bromine (Br) based flame retardants meet JS709B low halogen requirements of <=1000ppm threshold. Antimony trioxide based flame retardants must also meet the <=1000ppm threshold requirement.

(3) MSL, Peak Temp. - The Moisture Sensitivity Level rating according to the JEDEC industry standard classifications, and peak solder temperature.

(4) There may be additional marking, which relates to the logo, the lot trace code information, or the environmental category on the device.

(5) Multiple Device Markings will be inside parentheses. Only one Device Marking contained in parentheses and separated by a "-" will appear on a device. If a line is indented then it is a continuation of the previous line and the two combined represent the entire Device Marking for that device.

(6) Lead finish/Ball material - Orderable Devices may have multiple material finish options. Finish options are separated by a vertical ruled line. Lead finish/Ball material values may wrap to two lines if the finish value exceeds the maximum column width.

**Important Information and Disclaimer:** The information provided on this page represents TI's knowledge and belief as of the date that it is provided. TI bases its knowledge and belief on information provided by third parties, and makes no representation or warranty as to the accuracy of such information. Efforts are underway to better integrate information from third parties. TI has taken and continues to take reasonable steps to provide representative and accurate information but may not have conducted destructive testing or chemical analysis on incoming materials and chemicals. TI and TI suppliers consider certain information to be proprietary, and thus CAS numbers and other limited information may not be available for release.

In no event shall TI's liability arising out of such information exceed the total purchase price of the TI part(s) at issue in this document sold by TI to Customer on an annual basis.

**TRAY**

Chamfer on Tray corner indicates Pin 1 orientation of packed units.

\*All dimensions are nominal

Device	Package Name	Package Type	Pins	SPQ	Unit array matrix	Max temperature (°C)	L (mm)	W (mm)	K0 (µm)	P1 (mm)	CL (mm)	CW (mm)
DAC60096IZEB	ZEB	NFBGA	196	126	7 X 18	150	315	135.9	7620	17.2	11.3	16.35

# ZEB0196A

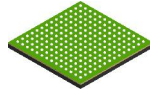

# PACKAGE OUTLINE

## NFBGA - 1.48 mm max height

PLASTIC BALL GRID ARRAY

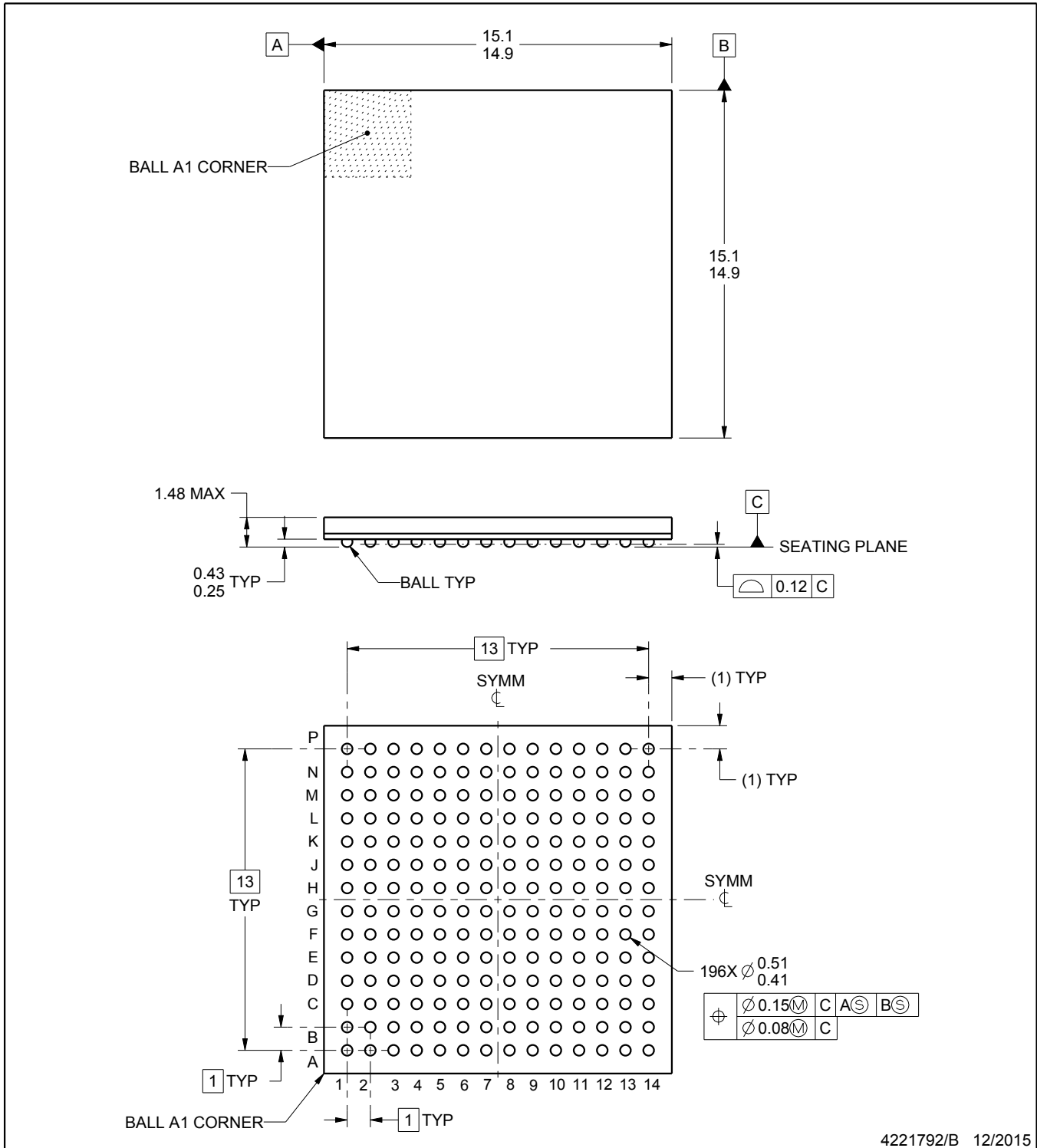

4221792/B 12/2015

### NOTES:

1. All linear dimensions are in millimeters. Any dimensions in parenthesis are for reference only. Dimensioning and tolerancing per ASME Y14.5M.
2. This drawing is subject to change without notice.



# EXAMPLE BOARD LAYOUT

ZEB0196A

NFBGA - 1.48 mm max height

PLASTIC BALL GRID ARRAY

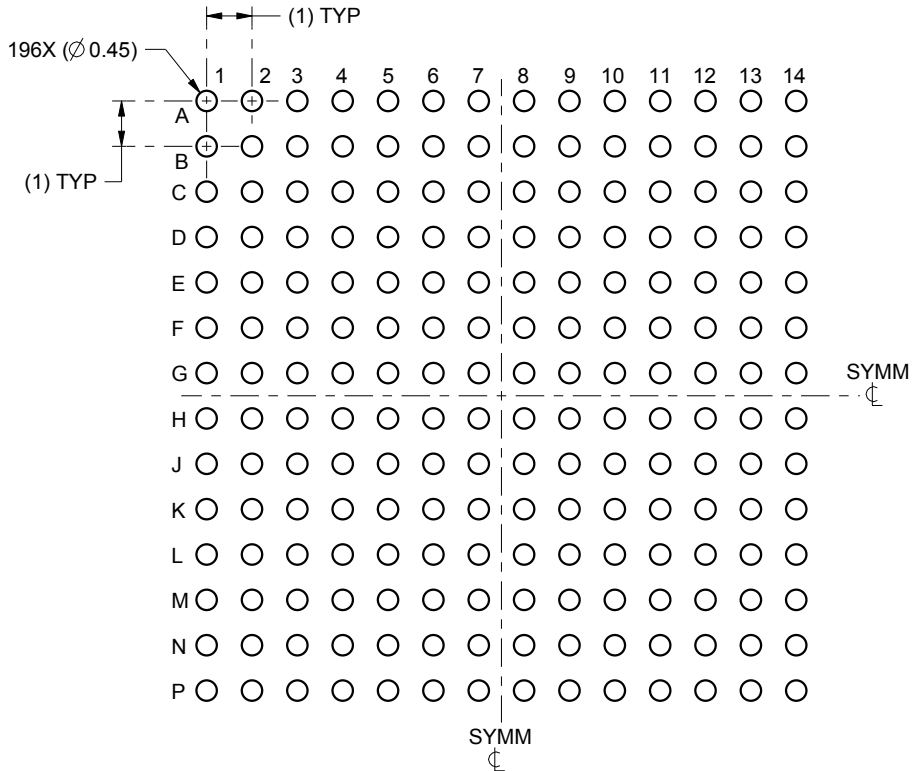

LAND PATTERN EXAMPLE  
SCALE:6X

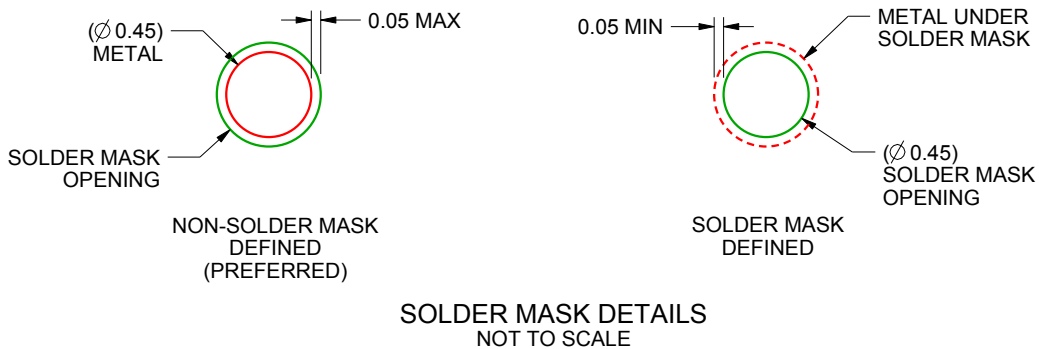

SOLDER MASK DETAILS  
NOT TO SCALE

4221792/B 12/2015

NOTES: (continued)

- Final dimensions may vary due to manufacturing tolerance considerations and also routing constraints. For information, see Texas Instruments literature number SPRAA99 ([www.ti.com/lit/spraa99](http://www.ti.com/lit/spraa99)).

# EXAMPLE STENCIL DESIGN

ZEB0196A

NFBGA - 1.48 mm max height

PLASTIC BALL GRID ARRAY

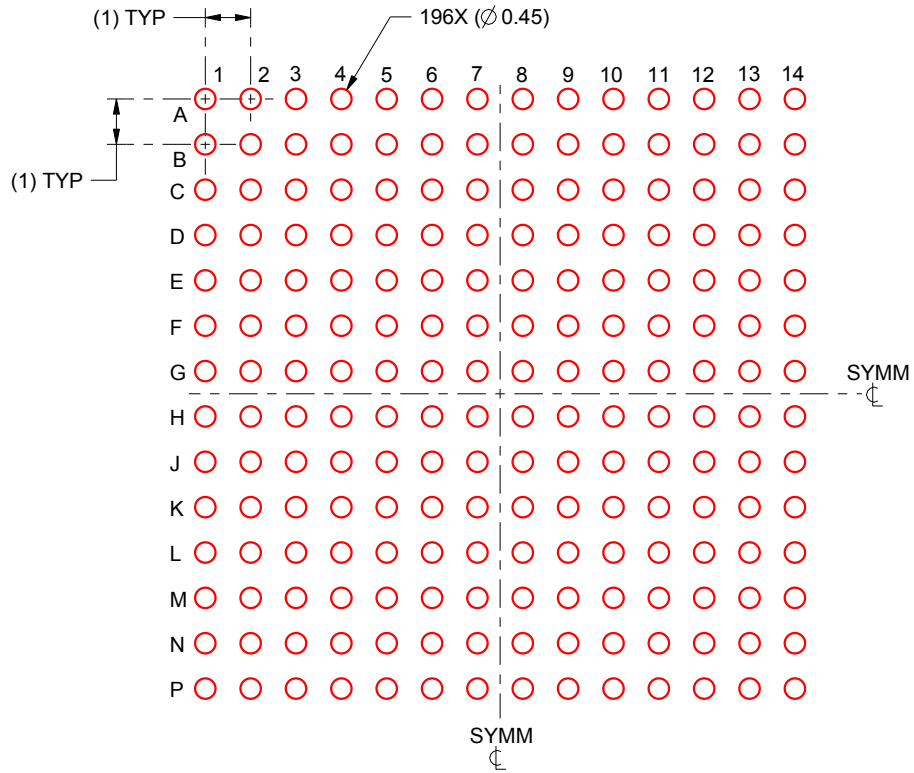

SOLDER PASTE EXAMPLE  
BASED ON 0.15 mm THICK STENCIL  
SCALE:6X

4221792/B 12/2015

NOTES: (continued)

4. Laser cutting apertures with trapezoidal walls and rounded corners may offer better paste release.

## IMPORTANT NOTICE AND DISCLAIMER

TI PROVIDES TECHNICAL AND RELIABILITY DATA (INCLUDING DATA SHEETS), DESIGN RESOURCES (INCLUDING REFERENCE DESIGNS), APPLICATION OR OTHER DESIGN ADVICE, WEB TOOLS, SAFETY INFORMATION, AND OTHER RESOURCES "AS IS" AND WITH ALL FAULTS, AND DISCLAIMS ALL WARRANTIES, EXPRESS AND IMPLIED, INCLUDING WITHOUT LIMITATION ANY IMPLIED WARRANTIES OF MERCHANTABILITY, FITNESS FOR A PARTICULAR PURPOSE OR NON-INFRINGEMENT OF THIRD PARTY INTELLECTUAL PROPERTY RIGHTS.

These resources are intended for skilled developers designing with TI products. You are solely responsible for (1) selecting the appropriate TI products for your application, (2) designing, validating and testing your application, and (3) ensuring your application meets applicable standards, and any other safety, security, regulatory or other requirements.

These resources are subject to change without notice. TI grants you permission to use these resources only for development of an application that uses the TI products described in the resource. Other reproduction and display of these resources is prohibited. No license is granted to any other TI intellectual property right or to any third party intellectual property right. TI disclaims responsibility for, and you will fully indemnify TI and its representatives against, any claims, damages, costs, losses, and liabilities arising out of your use of these resources.

TI's products are provided subject to [TI's Terms of Sale](#) or other applicable terms available either on [ti.com](http://ti.com) or provided in conjunction with such TI products. TI's provision of these resources does not expand or otherwise alter TI's applicable warranties or warranty disclaimers for TI products.

TI objects to and rejects any additional or different terms you may have proposed.

Mailing Address: Texas Instruments, Post Office Box 655303, Dallas, Texas 75265  
Copyright © 2022, Texas Instruments Incorporated