

FDMC8010ET30

MOSFET – N-Channel, POWERTRENCH® 30 V, 174 A, 1.3 mΩ

General Description

This N-Channel MOSFET is produced using ON Semiconductor's advanced POWERTRENCH process that has been especially tailored to minimize the on-state resistance. This device is well suited for applications where ultra low $r_{DS(on)}$ is required in small spaces such as High performance VRM, POL and Oring functions.

Features

- Extended T_J Rating to 175°C
- Max $r_{DS(on)} = 1.3\text{ m}\Omega$ at $V_{GS} = 10\text{ V}$, $I_D = 30\text{ A}$
- Max $r_{DS(on)} = 1.8\text{ m}\Omega$ at $V_{GS} = 4.5\text{ V}$, $I_D = 25\text{ A}$
- High Performance Technology for Extremely Low $r_{DS(on)}$
- These Devices are Pb-Free and are RoHS Compliant

Applications

- DC – DC Buck Converters
- Point of Load
- High Efficiency Load Switch and Low Side Switching
- Oring FET

MOSFET MAXIMUM RATINGS ($T_A = 25^\circ\text{C}$ Unless Otherwise Noted)

| Symbol | Parameter | Ratings | Units |
|----------------|--|-------------|-------|
| V_{DS} | Drain to Source Voltage | 30 | V |
| V_{GS} | Gate to Source Voltage (Note 4) | ± 20 | V |
| I_D | Drain Current | | A |
| | –Continuous $T_C = 25^\circ\text{C}$ (Note 6) | 174 | |
| | –Continuous $T_C = 100^\circ\text{C}$ (Note 6) | 123 | |
| | –Continuous $T_A = 25^\circ\text{C}$ (Note 1a) | 30 | |
| | –Pulsed (Note 5) | 835 | |
| EAS | Single Pulse Avalanche Energy (Note 3) | 153 | mJ |
| P_D | Power Dissipation $T_C = 25^\circ\text{C}$ | 65 | W |
| | Power Dissipation $T_A = 25^\circ\text{C}$ (Note 1a) | 2.8 | |
| T_J, T_{STG} | Operating and Storage Junction Temperature Range | -55 to +150 | °C |

Stresses exceeding those listed in the Maximum Ratings table may damage the device. If any of these limits are exceeded, device functionality should not be assumed, damage may occur and reliability may be affected.

THERMAL CHARACTERISTICS

| Symbol | Parameter | Ratings | Unit |
|-----------------|---|---------|------|
| $R_{\theta JC}$ | Thermal Resistance, Junction to Case | 1.3 | °C/W |
| $R_{\theta JA}$ | Thermal Resistance, Junction to Ambient (Note 1a) | 53 | °C/W |



ON Semiconductor®

www.onsemi.com

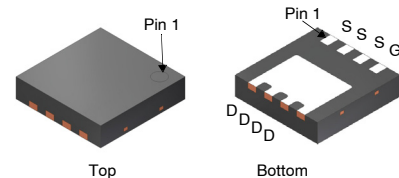

PQFN8 3.3x3.3, 0.65P
CASE 483AW
Power 33

MARKING DIAGRAM

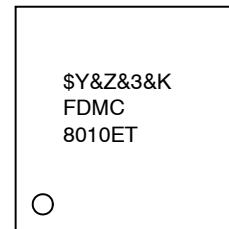

\$Y = ON Semiconductor Logo
&Z = Assembly Plant Code
&3 = Numeric Date Code
&K = Lot Code
FDMC8010ET = Specific Device Code

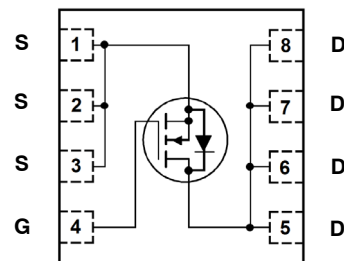

ORDERING INFORMATION

See detailed ordering, marking and shipping information in the package dimensions section on page 2 of this data sheet.

FDMC8010ET30

PACKAGE MARKING AND ORDERING INFORMATION

| Device Marking | Device | Package | Reel Size | Tape Width | Quantity |
|----------------|--------------|----------|-----------|------------|------------|
| FDMC8010ET | FDMC8010ET30 | Power 33 | 13" | 12 mm | 3000 Units |

ELECTRICAL CHARACTERISTICS (T_J = 25°C unless otherwise noted)

| Symbol | Parameter | Test Condition | Min | Typ | Max | Unit |
|--------|-----------|----------------|-----|-----|-----|------|
|--------|-----------|----------------|-----|-----|-----|------|

OFF CHARACTERISTICS

| | | | | | | |
|-------------------------------------|---|---|----|----|-----|-------|
| BV _{DSS} | Drain to Source Breakdown Voltage | I _D = 1 mA, V _{GS} = 0 V | 30 | | | V |
| ΔBV _{DSS} /ΔT _J | Breakdown Voltage Temperature Coefficient | I _D = 1 mA, referenced to 25°C | | 15 | | mV/°C |
| I _{DSS} | Zero Gate Voltage Drain Current | V _{DS} = 24 V, V _{GS} = 0 V | | | 1 | μA |
| I _{GSS} | Gate to Source Leakage Current | V _{GS} = 20 V, V _{DS} = 0 V | | | 100 | nA |

ON CHARACTERISTICS

| | | | | | | |
|---------------------------------------|--|---|-----|-----|-----|-------|
| V _{GS(th)} | Gate to Source Threshold Voltage | V _{GS} = V _{DS} , I _D = 1 mA | 1.2 | 1.5 | 2.5 | V |
| ΔV _{GS(th)} /ΔT _J | Gate to Source Threshold Voltage Temperature Coefficient | I _D = 1 mA, referenced to 25°C | | -5 | | mV/°C |
| r _{DS(on)} | Static Drain to Source On Resistance | V _{GS} = 10 V, I _D = 30 A | | 0.9 | 1.3 | mΩ |
| | | V _{GS} = 4.5 V, I _D = 25 A | | 1.3 | 1.8 | |
| | | V _{GS} = 10 V, I _D = 30 A, T _J = 125°C | | 1.3 | 2 | |
| g _{FS} | Forward Transconductance | V _{DS} = 5 V, I _D = 30 A | | 188 | | S |

DYNAMIC CHARACTERISTICS

| | | | | | | |
|------------------|------------------------------|---|-----|------|------|----|
| C _{iss} | Input Capacitance | V _{DS} = 15 V, V _{GS} = 0 V, f = 1 MHz | | 4405 | 5860 | pF |
| C _{oss} | Output Capacitance | | | 1570 | 2090 | pF |
| C _{rss} | Reverse Transfer Capacitance | | | 167 | 250 | pF |
| R _g | Gate Resistance | | 0.1 | 0.5 | 1.25 | Ω |

SWITCHING CHARACTERISTICS

| | | | | | | |
|---------------------|-------------------------------|--|---|-----|----|----|
| t _{d(on)} | Turn-On Delay Time | V _{DD} = 15 V, I _D = 30 A, V _{GS} = 10 V, R _{GEN} = 6 Ω | | 15 | 27 | ns |
| t _r | Rise Time | | | 7.5 | 15 | ns |
| t _{d(off)} | Turn-Off Delay Time | | | 40 | 64 | ns |
| t _f | Fall Time | | | 5.3 | 11 | ns |
| Q _g | Total Gate Charge | V _{GS} = 0 V to 10 V | V _{DD} = 15 V I _D = 30 A | 67 | 94 | nC |
| Q _g | Total Gate Charge | V _{GS} = 0 V to 4.5 V | | 32 | 45 | nC |
| Q _{gs} | Gate to Source Charge | | | 10 | | nC |
| Q _{gd} | Gate to Drain "Miller" Charge | | | 9.5 | | nC |

DRAIN-SOURCE DIODE CHARACTERISTICS

| | | | | | | |
|-----------------|---------------------------------------|---|--|-----|-----|----|
| V _{SD} | Source to Drain Diode Forward Voltage | V _{GS} = 0 V, I _S = 2 A (Note 2) | | 0.6 | 1.2 | V |
| | | V _{GS} = 0 V, I _S = 30 A (Note 2) | | 0.7 | 1.2 | |
| t _{rr} | Reverse Recovery Time | I _F = 30 A, di/dt = 100 A/μs | | 49 | 78 | ns |
| Q _{rr} | Reverse Recovery Charge | | | 29 | 46 | nC |

FDMC8010ET30

NOTES:

1. $R_{\theta JA}$ is determined with the device mounted on a 1 in² pad 2 oz copper pad on a 1.5 x 1.5 in. board of FR-4 material. $R_{\theta CA}$ is determined by the user's board design.

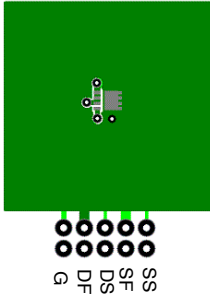

a. 53 °C/W when mounted on a 1 in² pad of 2 oz copper.

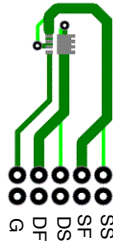

b. 125 °C/W when mounted on a minimum pad of 2 oz copper.

2. Pulse Test: Pulse Width < 300 μ s, Duty cycle < 2.0 %.
3. E_{AS} of 153 mJ is based on starting $T_J = 25^\circ\text{C}$, $L = 0.3$ mH, $I_{AS} = 32$ A, $V_{DD} = 27$ V, $V_{GS} = 10$ V. 100% test at $L = 0.1$ mH, $I_{AS} = 47$ A.
4. As an N-ch device, the negative V_{gs} rating is for low duty cycle pulse occurrence only. No continuous rating is implied.
5. Pulsed I_d please refer to Figure 11 SOA graph for more details.
6. Computed continuous current limited to Max Junction Temperature only, actual continuous current will be limited by thermal & electro-mechanical application board design.

TYPICAL CHARACTERISTICS

$T_J = 25^\circ\text{C}$ Unless Otherwise Noted

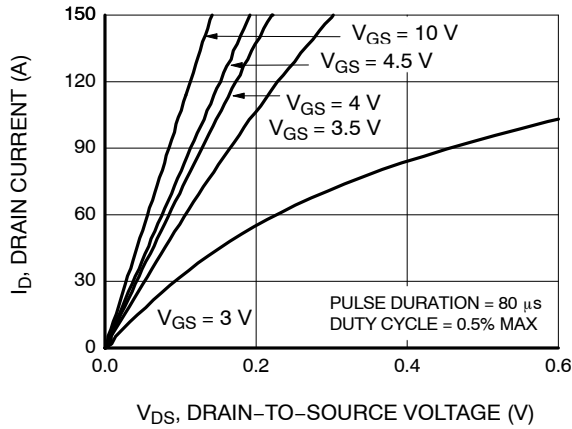

Figure 1. On-Region Characteristics

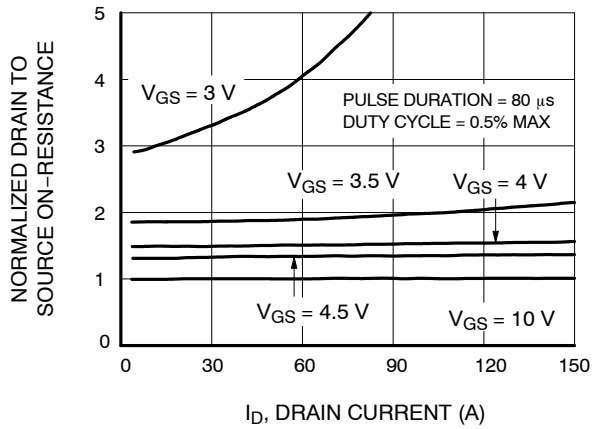

Figure 2. Normalized On-Resistance vs Drain Current and Gate Voltage

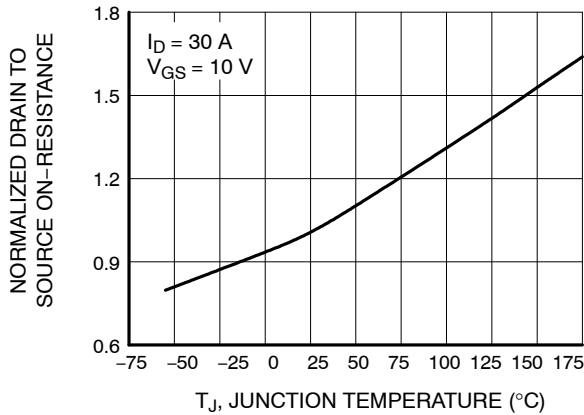

Figure 3. Normalized On Resistance vs Junction Temperature

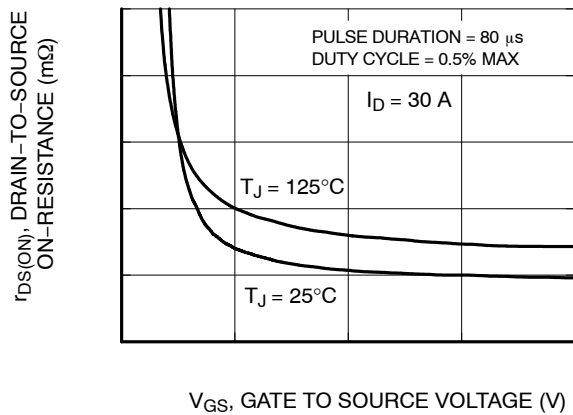

Figure 4. On-Resistance vs Gate to Source Voltage

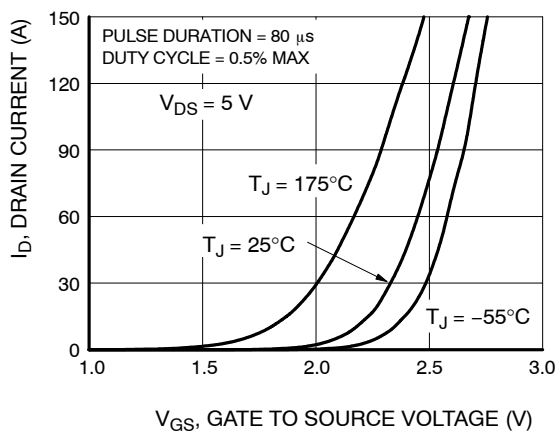

Figure 5. Transfer Characteristics

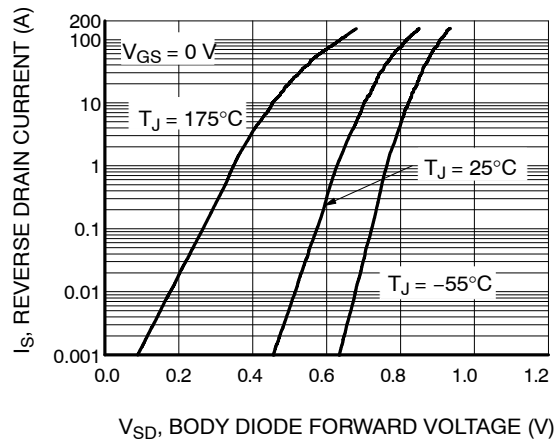

Figure 6. Source to Drain Diode Forward Voltage vs Source Current

FDMC8010ET30

TYPICAL CHARACTERISTICS (continued)

$T_J = 25^\circ\text{C}$ Unless Otherwise Noted

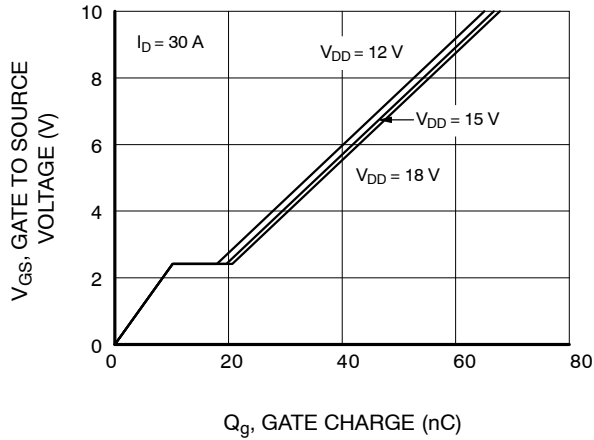

Figure 7. Gate Charge Characteristics

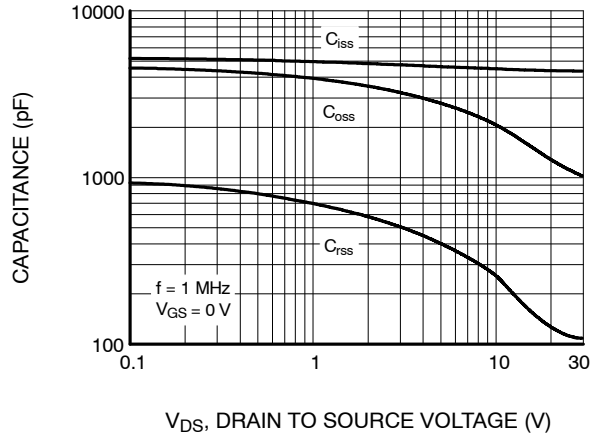

Figure 8. Capacitance vs Drain to Source Voltage

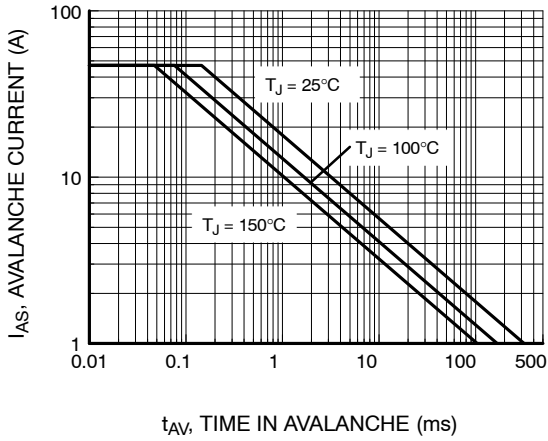

Figure 9. Unclamped Inductive Switching Capability

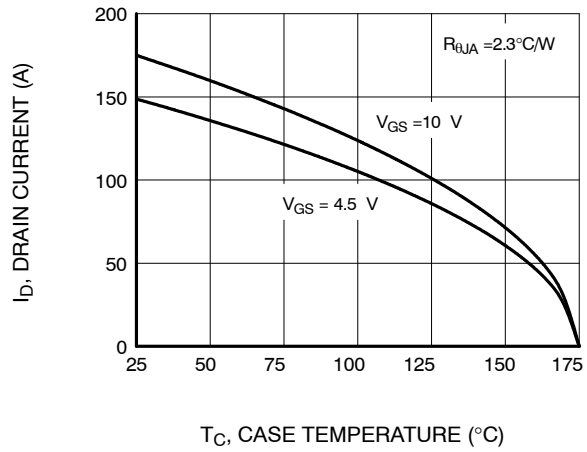

Figure 10. Maximum Continuous Drain Current vs Case Temperature

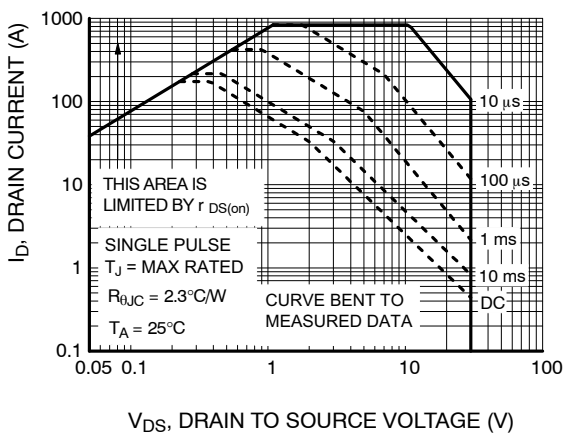

Figure 11. Forward Bias Safe Operating Area

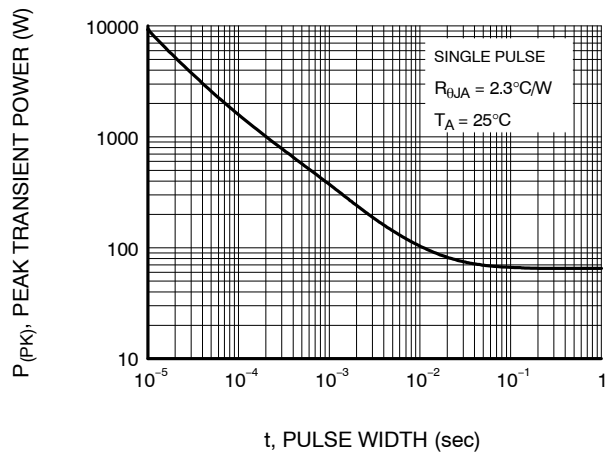
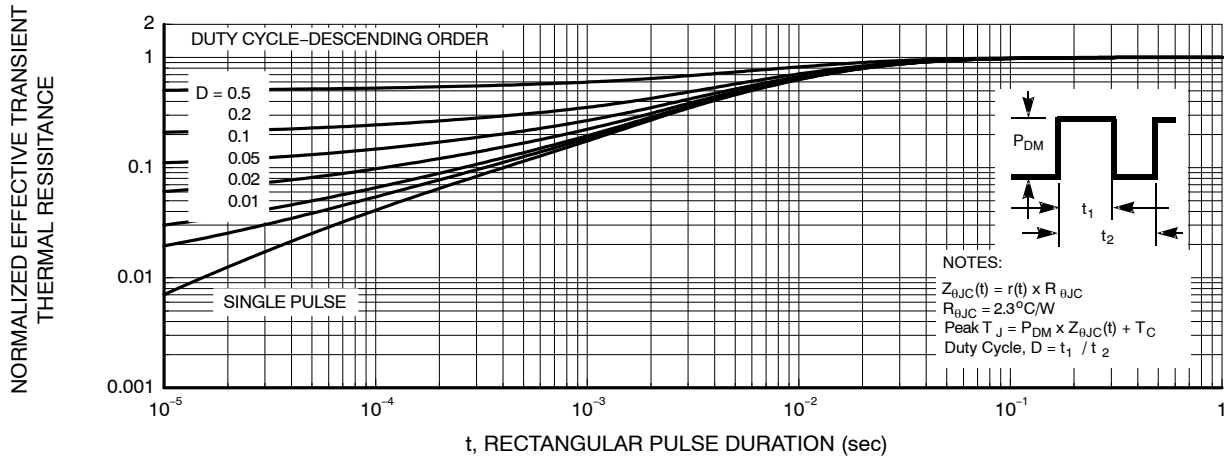

Figure 12. Single Pulse Maximum Power Dissipation

FDMC8010ET30

TYPICAL CHARACTERISTICS (continued)

$T_J = 25^\circ\text{C}$ Unless Otherwise Noted



POWERTRENCH are registered trademarks of Semiconductor Components Industries, LLC (SCILLC) or its subsidiaries in the United States and/or other countries.

MECHANICAL CASE OUTLINE

PACKAGE DIMENSIONS

ON Semiconductor®

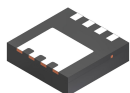

WDFN8 3.3X3.3, 0.65P
CASE 483AW
ISSUE A

DATE 10 SEP 2019

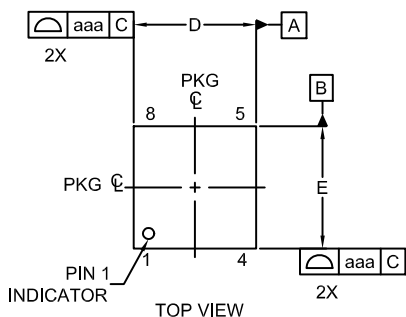

TOP VIEW

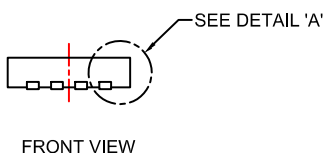

FRONT VIEW

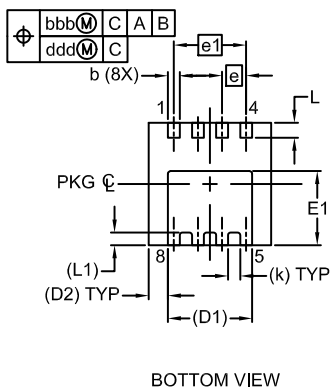

BOTTOM VIEW

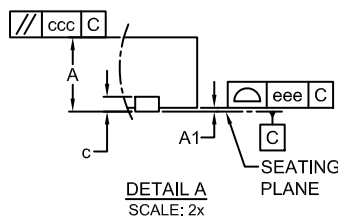

DETAIL A
SCALE: 2x

LAND PATTERN RECOMMENDATION*

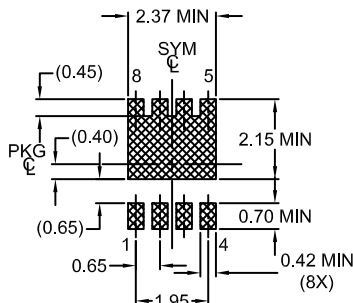

NOTES:

1. CONTROLLING DIMENSION: MILLIMETERS.
2. COPLANARITY APPLIES TO THE EXPOSED PADS AS WELL AS THE TERMINALS.
3. DIMENSIONS D AND E DO NOT INCLUDE MOLD FLASH, PROTRUSIONS OR GATE BURRS.
4. SEATING PLANE IS DEFINED BY THE TERMINALS. 'A1' IS DEFINED AS THE DISTANCE FROM THE SEATING PLANE TO THE LOWEST POINT ON THE PACKAGE BODY.

| DIM | MILLIMETERS | | |
|-----|-------------|------|------|
| | MIN | NOM | MAX |
| A | 0.70 | 0.75 | 0.80 |
| A1 | - | - | 0.05 |
| b | 0.27 | 0.32 | 0.37 |
| c | 0.15 | 0.20 | 0.25 |
| D | 3.20 | 3.30 | 3.40 |
| D1 | 2.27 REF | | |
| D2 | 0.52 REF | | |
| E | 3.20 | 3.30 | 3.40 |
| E1 | 1.85 | 1.95 | 2.05 |
| e | 0.65 BSC | | |
| e1 | 1.95 BSC | | |
| k | 0.33 REF | | |
| L | 0.30 | 0.40 | 0.50 |
| L1 | 0.34 REF | | |
| aaa | 0.10 | | |
| bbb | 0.10 | | |
| ccc | 0.10 | | |
| ddd | 0.05 | | |
| eee | 0.05 | | |

*FOR ADDITIONAL INFORMATION ON OUR PB-FREE STRATEGY AND SOLDERING DETAILS, PLEASE DOWNLOAD THE ON SEMICONDUCTOR SOLDERING AND MOUNTING TECHNIQUES REFERENCE MANUAL, SOLDERRM/D.

GENERIC MARKING DIAGRAM*



XXXX = Specific Device Code
 A = Assembly Location
 Y = Year
 WW = Work Week

*This information is generic. Please refer to device data sheet for actual part marking. Pb-Free indicator, "G" or microdot "▪", may or may not be present. Some products may not follow the Generic Marking.

| | | |
|-------------------------|-----------------------------|--|
| DOCUMENT NUMBER: | 98AON13672G | Electronic versions are uncontrolled except when accessed directly from the Document Repository. Printed versions are uncontrolled except when stamped "CONTROLLED COPY" in red. |
| DESCRIPTION: | WDFN8 3.3X3.3, 0.65P | PAGE 1 OF 1 |

ON Semiconductor and ON are trademarks of Semiconductor Components Industries, LLC dba ON Semiconductor or its subsidiaries in the United States and/or other countries. ON Semiconductor reserves the right to make changes without further notice to any products herein. ON Semiconductor makes no warranty, representation or guarantee regarding the suitability of its products for any particular purpose, nor does ON Semiconductor assume any liability arising out of the application or use of any product or circuit, and specifically disclaims any and all liability, including without limitation special, consequential or incidental damages. ON Semiconductor does not convey any license under its patent rights nor the rights of others.

onsemi, **Onsemi**, and other names, marks, and brands are registered and/or common law trademarks of Semiconductor Components Industries, LLC dba "**onsemi**" or its affiliates and/or subsidiaries in the United States and/or other countries. **onsemi** owns the rights to a number of patents, trademarks, copyrights, trade secrets, and other intellectual property. A listing of **onsemi**'s product/patent coverage may be accessed at www.onsemi.com/site/pdf/Patent-Marking.pdf. **onsemi** reserves the right to make changes at any time to any products or information herein, without notice. The information herein is provided "as-is" and **onsemi** makes no warranty, representation or guarantee regarding the accuracy of the information, product features, availability, functionality, or suitability of its products for any particular purpose, nor does **onsemi** assume any liability arising out of the application or use of any product or circuit, and specifically disclaims any and all liability, including without limitation special, consequential or incidental damages. Buyer is responsible for its products and applications using **onsemi** products, including compliance with all laws, regulations and safety requirements or standards, regardless of any support or applications information provided by **onsemi**. "Typical" parameters which may be provided in **onsemi** data sheets and/or specifications can and do vary in different applications and actual performance may vary over time. All operating parameters, including "Typicals" must be validated for each customer application by customer's technical experts. **onsemi** does not convey any license under any of its intellectual property rights nor the rights of others. **onsemi** products are not designed, intended, or authorized for use as a critical component in life support systems or any FDA Class 3 medical devices or medical devices with a same or similar classification in a foreign jurisdiction or any devices intended for implantation in the human body. Should Buyer purchase or use **onsemi** products for any such unintended or unauthorized application, Buyer shall indemnify and hold **onsemi** and its officers, employees, subsidiaries, affiliates, and distributors harmless against all claims, costs, damages, and expenses, and reasonable attorney fees arising out of, directly or indirectly, any claim of personal injury or death associated with such unintended or unauthorized use, even if such claim alleges that **onsemi** was negligent regarding the design or manufacture of the part. **onsemi** is an Equal Opportunity/Affirmative Action Employer. This literature is subject to all applicable copyright laws and is not for resale in any manner.

ADDITIONAL INFORMATION

TECHNICAL PUBLICATIONS:

Technical Library: www.onsemi.com/design/resources/technical-documentation
onsemi Website: www.onsemi.com

ONLINE SUPPORT: www.onsemi.com/support

For additional information, please contact your local Sales Representative at www.onsemi.com/support/sales