

Smart Regulator Series 7 to 26V Input, 1.0A, Fixed Output Voltage 3 terminals DC/DC Regulator



BP5293-xx Series

•General Description

The BP5293-xx series is one packaged 3 terminals Buck type DC/DC Converter built-in all parts of DC/DC converter.

High efficiency compared with 3 terminals regulator, and not necessary to heat sink. It's able to rearrange without redesign PCB, because of pin compatible. The built in input/output capacitors and coil is contribute to compact design.

Supplied DC30Vmax output fixed voltage which is 3.3V, 5.0V, 12.0V line up. The output max current is 1A.

High efficiency at light load with a SLLM™. It is most suitable for use in the equipment to reduce the standby power is required.

•Key Specifications

- Input Voltage Range: (BP5293-33): 7~26V
(BP5293-50): 7~26V
(BP5293-12): 17~26V
- Output Decision Voltage:(BP5293-33): 3.3V±3%
(BP5293-50): 5.0V±2%
(BP5293-12): 12V±5%
- Maximum Output Current: 1A (Max.)
- Operation Temperature Range: -25°C~85°C

•Features

- 1ch Buck DC/DC Converter
- SLLM™ control(Simple Light Load Mode)
- Efficiency=70%(@WOUT=10mW)
- Over current protection
- Short protection
- Under voltage lockout protection
- Soft start
- Not need to externals parts
- Small Package

•Applications

- Consumer applications such as Home appliances etc.
- Industrial equipment
- Amusement device

•Appearance



W: 16.0mm x H: 16.8mm x T: 7.2mm (Max.)

•Line up

Output Voltage Typ. Vo(T)	Product Name
3.3V	BP5293-33
5.0V	BP5293-50
12.0V	BP5293-12

•Typical Application Circuit

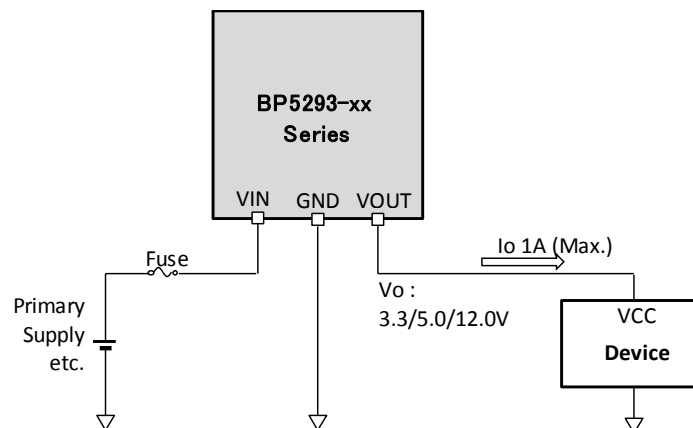

Figure.1 Application circuit

• Pin Configuration

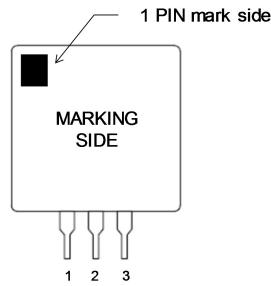

Figure.2 Pin Assignment

• Pin Descriptions

Pin No.	Symbol	Description
1	VIN	Input Power Supply terminal. This is supplied power source for the switching regulator and the controller. Though An input capacitor is not needed, If made a characteristic better, connect ceramic capacitor recommended 10 μ F.
2	GND	GND terminal
3	VOUT	Output terminal. This is output voltage of switching regulator. Though An input capacitor is not needed, If made a characteristic better, connect ceramic capacitor recommended 10 μ F.

• Block Diagram

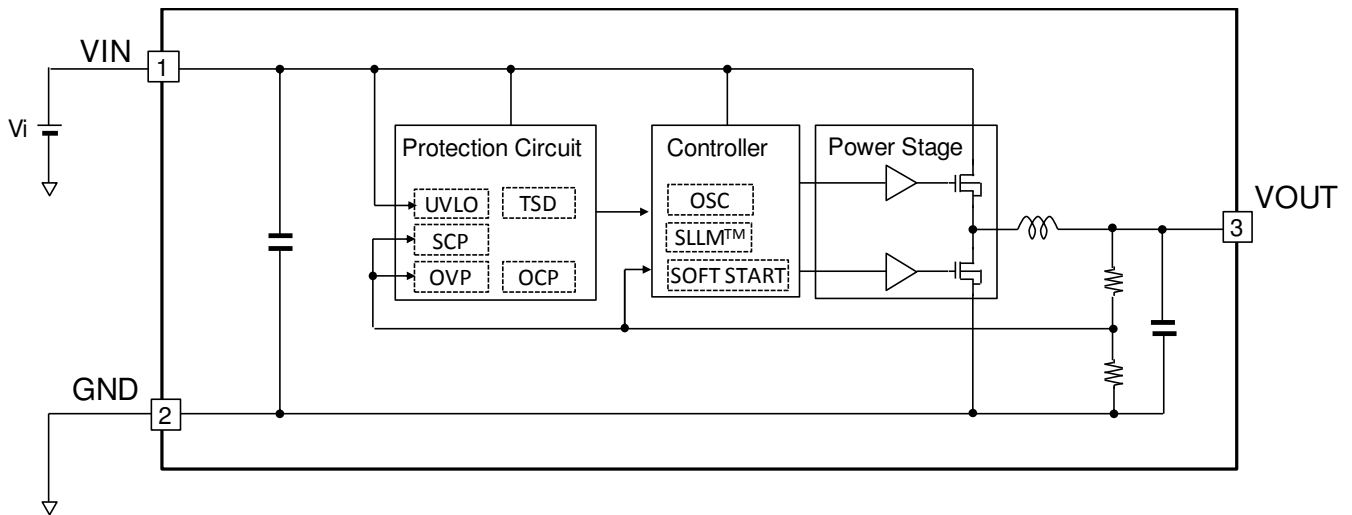

Figure.3 Block Diagram

●Description of Block

1. Controller

This block is controlled by switching regulator. By monitoring output voltage, controlled transistor switching to be fixed voltage Vo(T).By internal oscilattor circuit, the transistor is switching 570kHz typ for heavier load.

2. Power Stage

This block is built in two power MOSFETs and a power COIL which are parts for synchronous rectification type switching regulator. The on resistance of upper power MOSFET is 250mΩ typ and the on resistance of lower power MOSFET is 200mΩ.

3. Protection Circuit

- UVLO

This circuit is prevented abnormal function for under voltage dropped. When VIN goes under 6.4V typ, the switching function is stop. The detection voltage is hysteresis 200mV typ.

- TSD

This circuit is heat protection. When internal temparature goes over 175°C, the switching function is stop. If the temparature goes cold 150°C, the switching function return normal function

- SCP

This circuit is output short protection. If output voltage goes lower, and keeps among 0.9msec typ, the switching function is stop. After 14.4msec typ, the swiching fuction is return normal function.

- OVP

This circuit is output over voltage protection. If output voltage goes unexpected over voltage, the high-side MOSFET is OFF. When output voltage goes low which has hysteresis voltage, the switching function return.

- OCP

If over current, the high-side MOSFET is controled current every 1 cycle

●Absolute Maximum Ratings (Ta=25°C)

These are the values which must not be exceeded at any time under any application or any test conditions.

Please make design keeping margins accordingly

Parameter	Symbol	Rating	Unit	Conditions
Input Voltage	VinMAX	30	V	VIN terminal
Allowable maximum surface temperature	Tcmax	105	°C	Ambient temperature + The module self-heating ≤ Tcmax
Operating temperature range	Topr	-25 ~ +85	°C	
Storage temperature range	Tstg	-40 ~ +85	°C	
Maximum output current	IoMAX	1000	mA	

● Recommended Operating Ratings (Ta=-25°C ~ +85°C)

[BP5293-33, BP5293-50]

Parameter	Symbol	Rating			Unit	Conditions
		Min	Typ	Max		
Input Voltage	Vi	7	12	26	V	

[BP5293-12]

Parameter	Symbol	Rating			Unit	Conditions
		Min	Typ	Max		
Input Voltage	Vi	17	20	26	V	

● Electrical Characteristics

[BP5293-33] (Vi=12V, Io=500mA, Ta = +25°C unless otherwise specified)

Parameter	Symbol	Limits			Unit	Conditions
		Min	Typ	Max		
Output Voltage	Vo(T)	3.2	3.3	3.4	V	Io=0mA
Line Regulation	Vln	-	50	100	mV	Vi=7~26V
Load Regulation	Vlo	-	50	200	mV	Io=100~1000mA
Output Ripple voltage	Vp		50	200	mVpp	
Efficiency 1	η1	-	70	-	%	Iout=2mA
Efficiency 2	η2	86	90	-	%	Iout=1000mA
UVLO Voltage	Vuvlo	6.0	6.4	6.8	V	VIN falling

[BP5293-50] (Vi=12V, Io=500mA, Ta = +25°C unless otherwise specified)

Parameter	Symbol	Limits			Unit	Conditions
		Min	Typ	Max		
Output Voltage	Vo(T)	4.9	5.0	5.1	V	Io=0mA
Line Regulation	Vln	-	50	100	mV	Vi=7~26V
Load Regulation	Vlo	-	50	200	mV	Io=100~1000mA
Output Ripple voltage	Vp		50	200	mVpp	
Efficiency 1	η1	-	70	-	%	Iout=2mA
Efficiency 2	η2	86	90	-	%	Iout=1000mA
UVLO Voltage	Vuvlo	6.0	6.4	6.8	V	VIN falling

[BP5293-12] (Vi=20V, Io=500mA, Ta = +25°C unless otherwise specified)

Parameter	Symbol	Limits			Unit	Conditions
		Min	Typ	Max		
Output Voltage	Vo(T)	11.4	12	12.6	V	Io=0mA
Line Regulation	Vln	-	50	100	mV	Vi=17~26V
Load Regulation	Vlo	-	50	300	mV	Io=100~1000mA
Output Ripple voltage	Vp		50	200	mVpp	
Efficiency 1	η1	-	60	-	%	Iout=2mA
Efficiency 2	η2	86	90	-	%	Iout=1000mA
UVLO Voltage	Vuvlo	6.0	6.4	6.8	V	VIN falling

•Description

1) DC/DC converter function

BP5293-xx is a synchronous rectifying switching regulator that achieves faster transient response by employing current mode PWM control system. It utilizes switching operation for 570kHz (typ.) in PWM (Pulse Width Modulation) mode for heavier load, while it utilizes SLLM™(Simple Light Load Mode) control for lighter load to improve efficiency. While this mode, the switching function is stopped, It become waveform of output voltage like Fig5-1

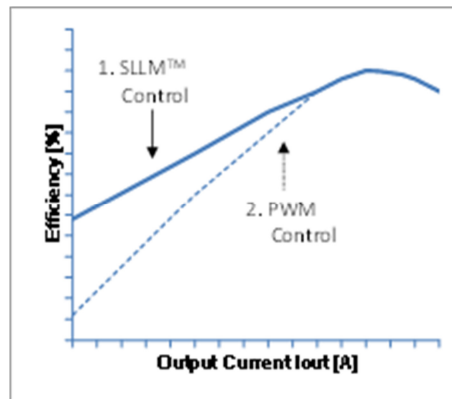

Figure.4 Efficiency (SLLM™ control and PWM control)

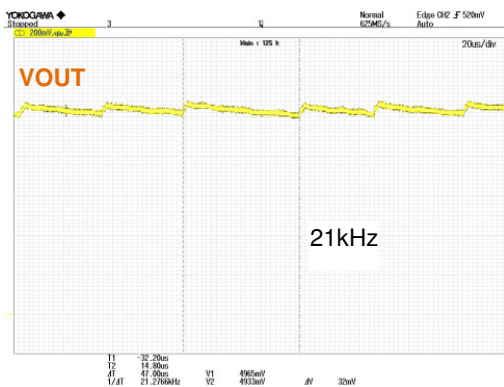

Figure.5-1 Output Waveform (SLLM™ control)
(Vin=12V, Vout=5.0V, Iout=10mA)

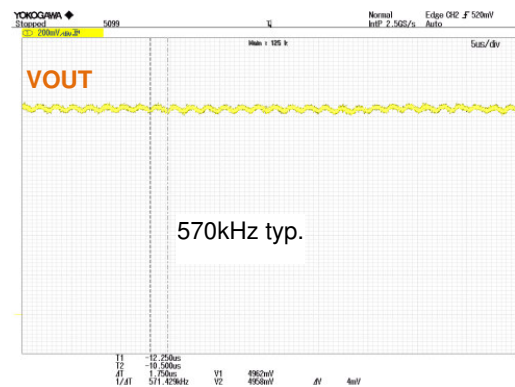

Figure.5-2 SW Waveform(PWM control)
(Vin=12V, Vout=5.0V, Iout=1000mA)

2) Protection circuit

The protective circuits are intended for prevention of damage caused by unexpected accidents. Do not use them for continuous protective operation.

2-1) Short Circuit Protection Function (SCP)

The short circuit protection circuit compares the VOUT terminal voltage with internal standard voltage V_{SCP} . When the VOUT terminal voltage has fallen below V_{SCP} and remained there for 0.9 msec (typ.), SCP stops the operation for 14.4 msec (typ.) and subsequently initiates a restart.

Table.1 SCP detection voltage

Product No.	SCP Detection Voltage V_{SCP}
BP5293-33	2.3V typ.
BP5293-50	3.5V typ.
BP5293-12	8.5V typ.

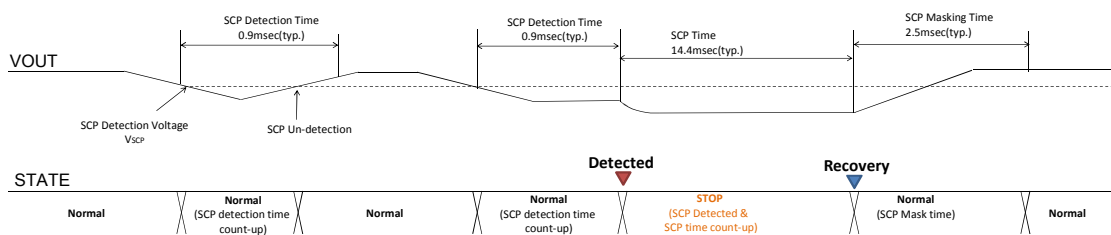

Figure.6 SCP Timing Chart

In the case of using big capacitor (330 μ F typ. Over), The VOUT rising is slow, the short protection function is maybe available, then take care of output normally.

2-2) Under Voltage Lockout Protection (UVLO)

The under voltage lockout protection circuit monitors the VIN terminal voltage. The operation enters standby when the VIN terminal voltage is 6.4V(typ.) or lower. The operation starts when the VIN terminal voltage is 6.6V(typ.) or higher.

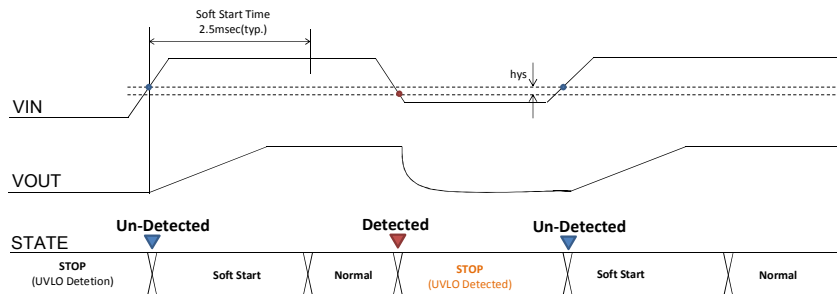

Figure.7 UVLO Timing Chart

2-3) Over Current Protection Function (OCP)

The over current protection function is monitoring every switching terms of input current, protect by dropping output voltage when over current detection.

2-4) Over Voltage Protection Function (OVP)

The over voltage protection function (OVP) compares VOUT terminal voltage with internal standard voltage V_{OVP} and when VOUT terminal voltage exceeds V_{OVP} it turns off output. After output voltage drop it returns with hysteresis.

Table.2 OVP detection voltage

Product No.	OVP Detection Voltage V_{OVP}
BP5293-33	4.3V typ.
BP5293-50	6.5V typ.
BP5293-12	15.9V typ.

• Typical Performance Curve (Reference data)

• BP5293-33

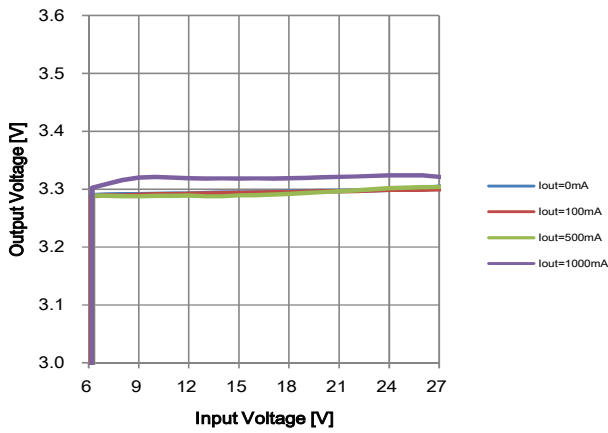

Figure.8-1 LINE Regulation (Vo : BP5293-33)

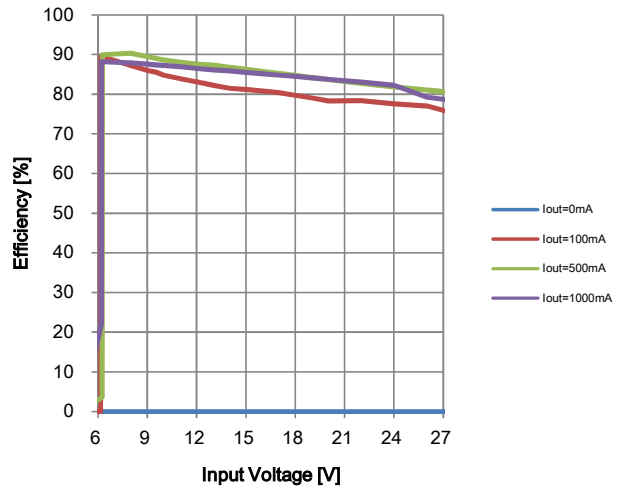

Figure.8-2 LINE Regulation (Efficiency : BP5293-33)

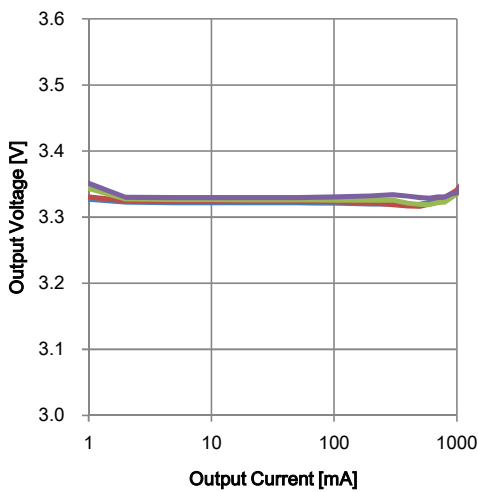

Figure.9-1 LINE Regulation (Vo : BP5293-33)

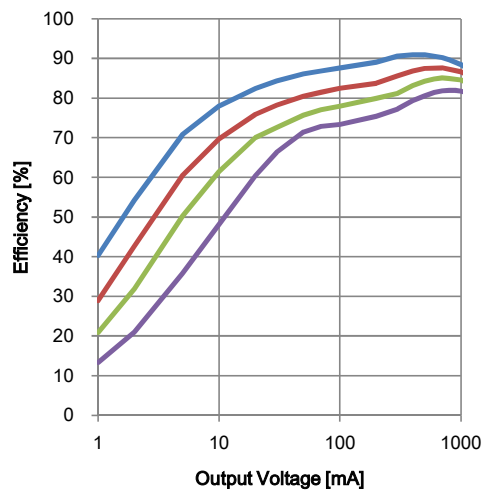

Figure.9-2 LINE Regulation (Efficiency : BP5293-33)

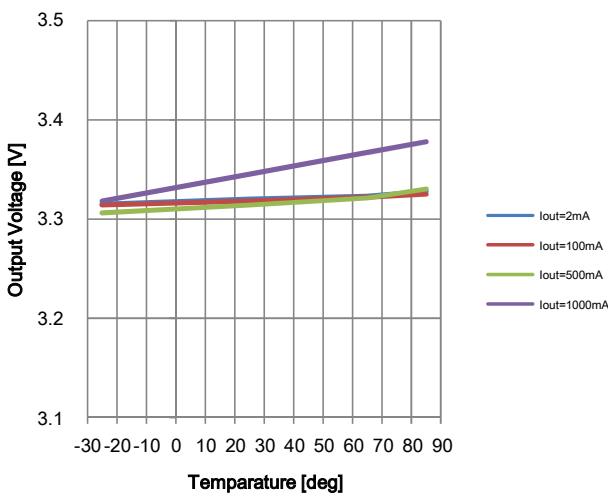

Figure.10-1 Temperature Characteristics (Vo: BP5293-33)

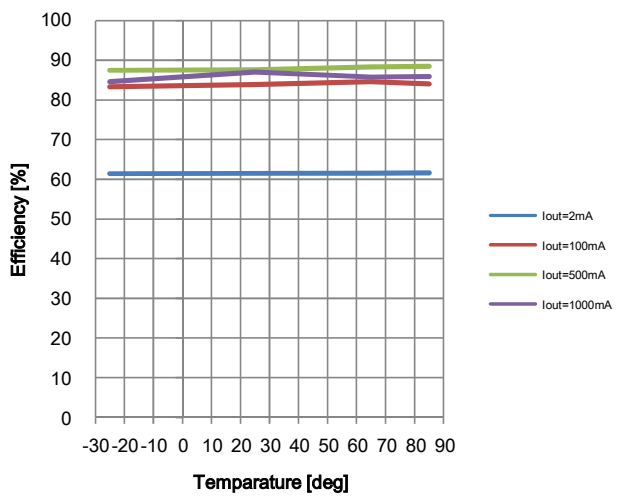

Figure.10-2 Temperature Characteristics (Vo: BP5293-33)

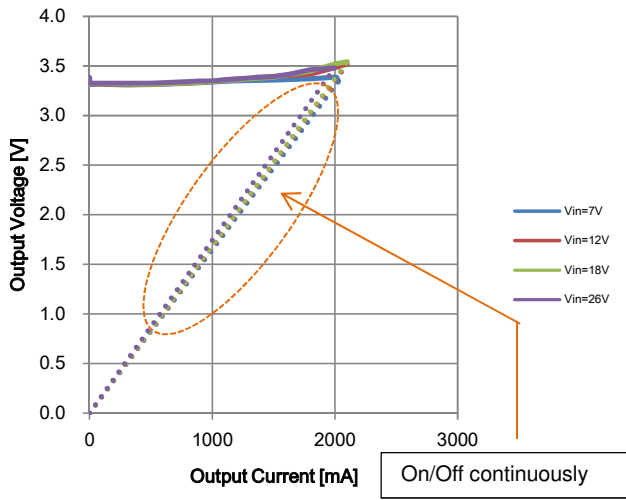

Figure.11 Over Current Limit (Vo: BP5293-33)

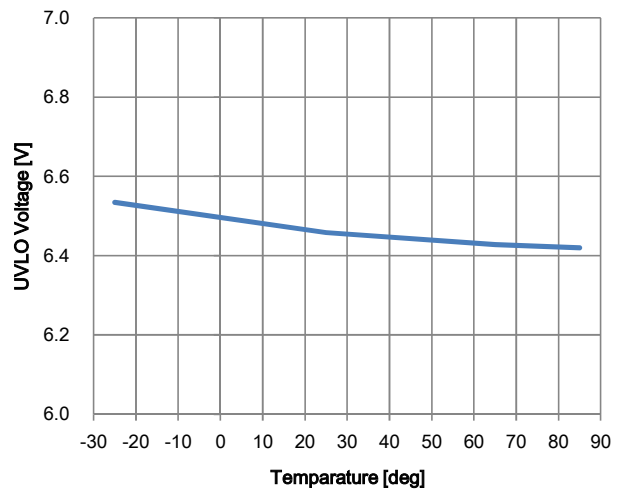

Figure.12 UVLO Voltage (Efficiency : BP5293-33)

Table.3 Reliability Test Result

TEST ITEM	STANDARD	TEST CONDITION	n (pcs)	pn (pcs)
Vibration Test	EIAJ ED4701 A-121 Condition A	10 ~ 55Hz, 1.5mm, X-Y-Z Direction Each 2h	5 pcs	0 pcs
Temp Cycle Test	EIAJ ED4701 B-131	Tstg(MIN) ~ Ambient Temp ~ Tstg(MAX), 3000cycle 30min 10min 30min	22 pcs	0 pcs
Temp Humidity Bias Test	EIAJ ED4701 B-122 Condition B	85°C, 85%RH, Voltage Supply 3000h	22 pcs	0 pcs
Electro Static Discharge HBM	EIAJ ED4701-304	C=100pF, R=1.5kΩ, 3times, ±2000V	5 pcs	0 pcs
Electro Static Discharge MM	EIAJ ED4701-304	C=200pF, R=0kΩ, 3times, ±200V	5 pcs	0 pcs

• BP5293-50

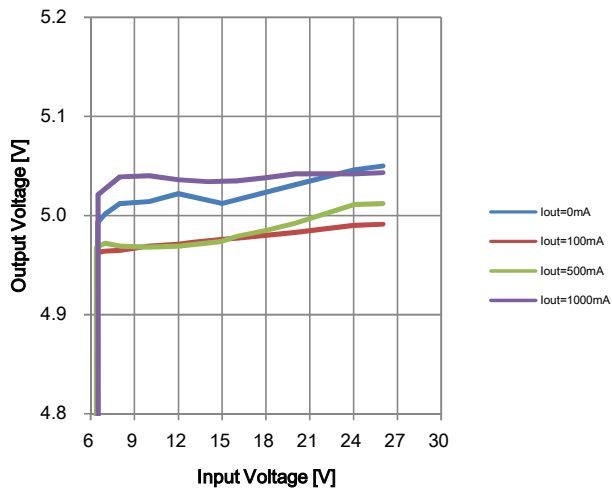

Figure.13-1 LINE Regulation (Vo: BP5293-50)

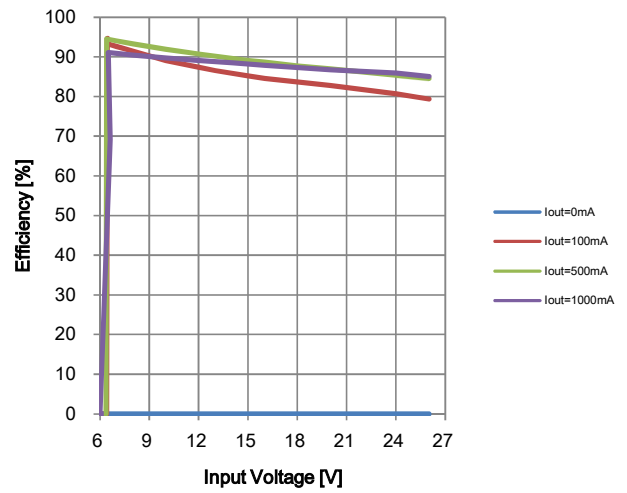

Figure.13-2 LINE Regulation (Efficiency: BP5293-50)

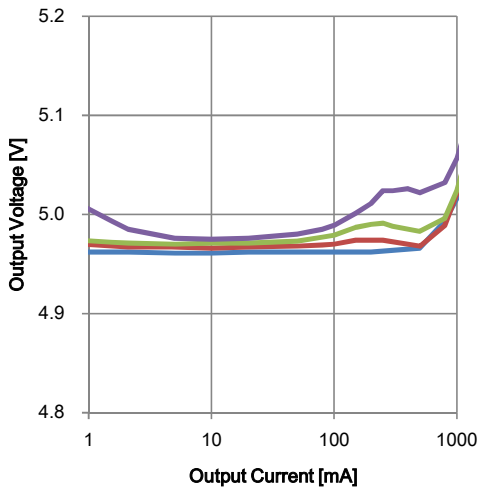

Figure.14-1 LINE Regulation (Vo: BP5293-50)

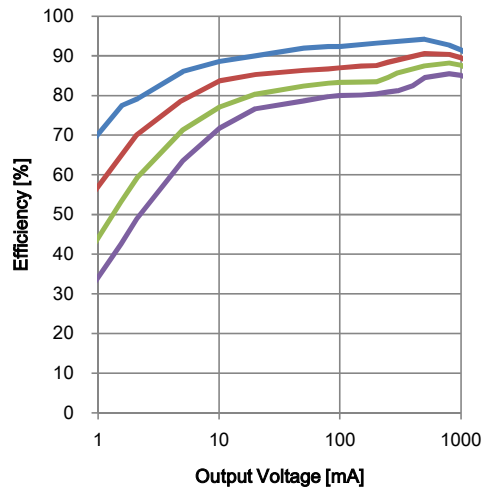

Figure.14-2 LINE Regulation (Efficiency: BP5293-50)

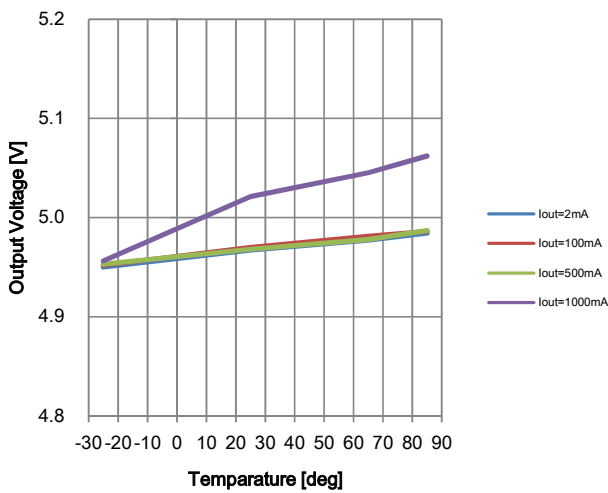

Figure.15-1 Temperature Characteristics (Vo: BP5293-50)

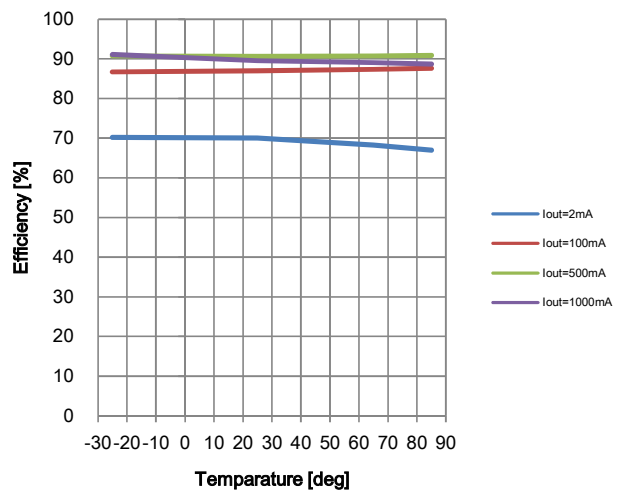

Figure.15-2 Temperature Characteristics (Vo: BP5293-50)

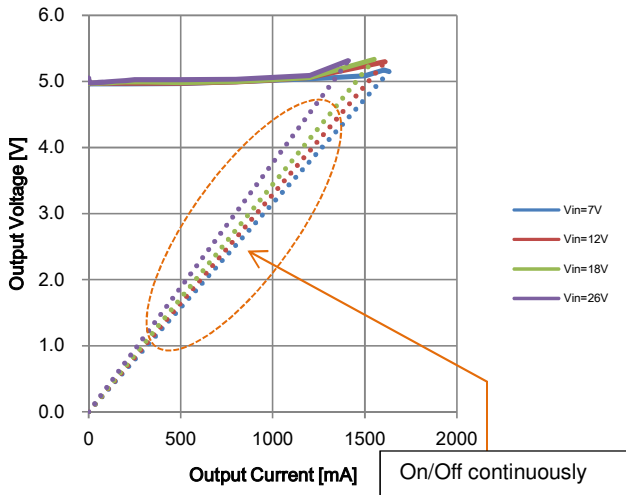

Figure.16 Over Current Limit (Vo: BP5293-50)

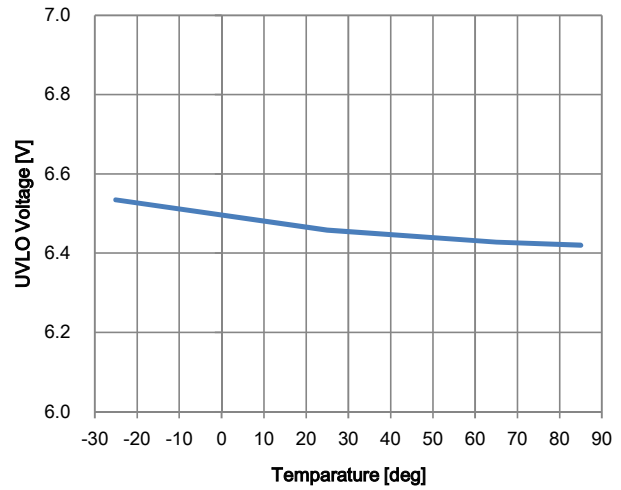

Figure.17 UVLO Voltage (Efficiency: BP5293-50)

Table.4 Reliability Test Result

TEST ITEM	STANDARD	TEST CONDITION	n (pcs)	pn (pcs)
Vibration Test	EIAJ ED4701 A-121 Condition A	10 ~ 55Hz, 1.5mm, X-Y-Z Direction Each 2h	5 pcs	0 pcs
Temp Cycle Test	EIAJ ED4701 B-131	Tstg(MIN) ~ Ambient Temp ~ Tstg(MAX), 3000cycle 30min 10min 30min	22 pcs	0 pcs
Temp Humidity Bias Test	EIAJ ED4701 B-122 Condition B	85°C, 85%RH, Voltage Supply 3000h	22 pcs	0 pcs
Electro Static Discharge HBM	EIAJ ED4701-304	C=100pF, R=1.5kΩ, 3times, ±2000V	5 pcs	0 pcs
Electro Static Discharge MM	EIAJ ED4701-304	C=200pF, R=0kΩ, 3times, ±200V	5 pcs	0 pcs

• BP5293-12

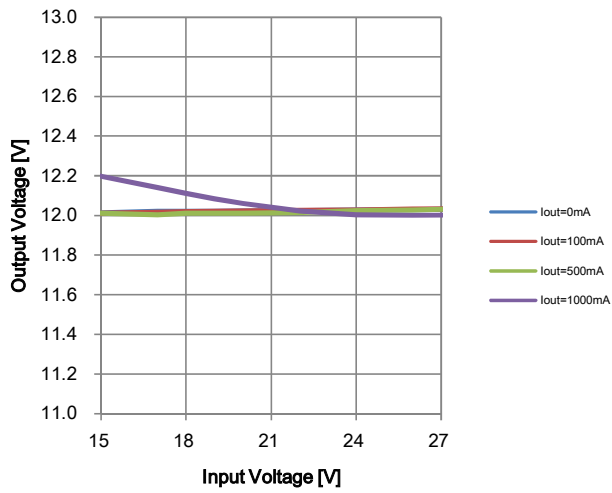

Figure.18-1 LINE Regulation (V_o : BP5293-12)

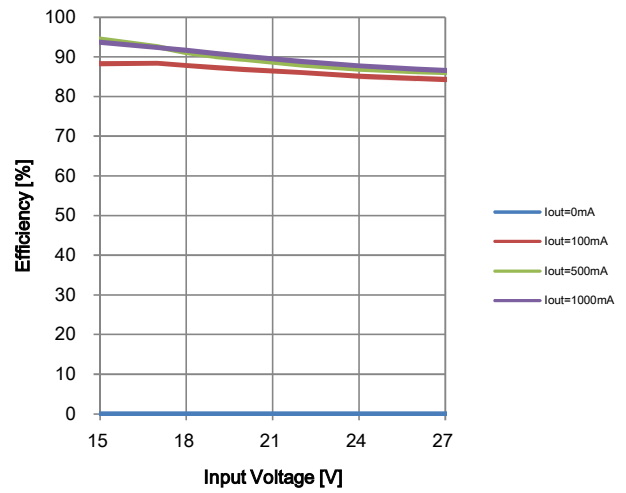

Figure.18-2 LINE Regulation (Efficiency : BP5293-12)

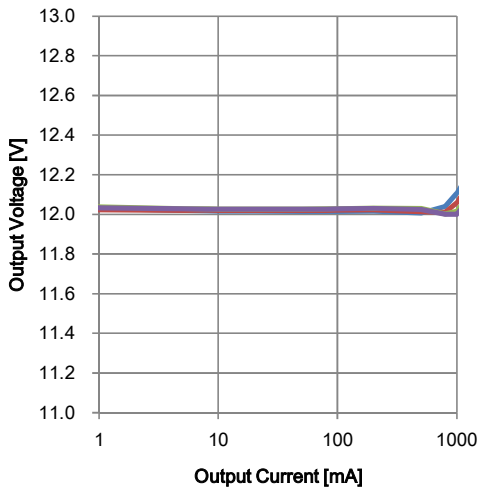

Figure.19-1 LINE Regulation (V_o : BP5293-12)

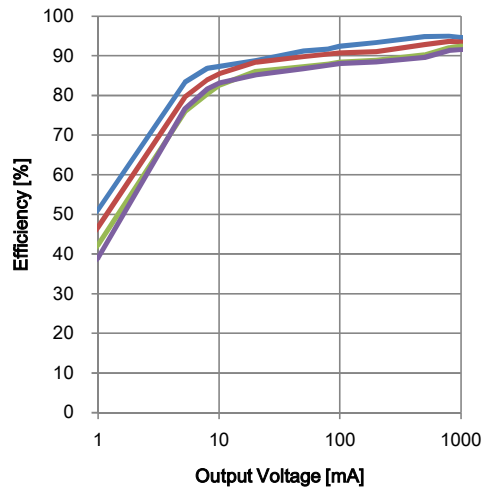

Figure.19-2 LINE Regulation (Efficiency: BP5293-12)

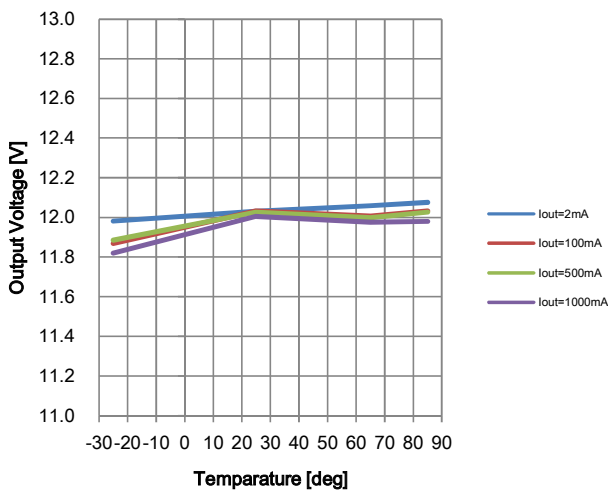

Figure.20-1 Temperature Characteristics (V_o : BP5293-12)

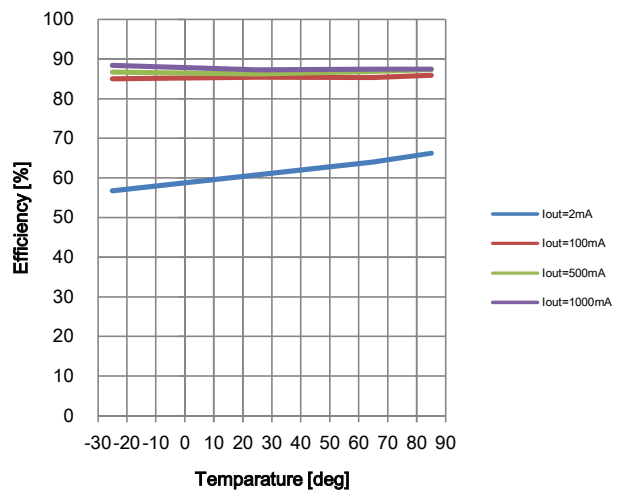

Figure.20-2 Temperature Characteristics (V_o : BP5293-12)

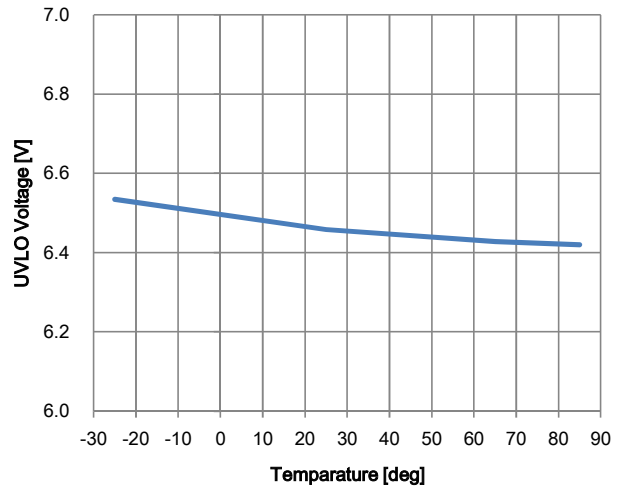
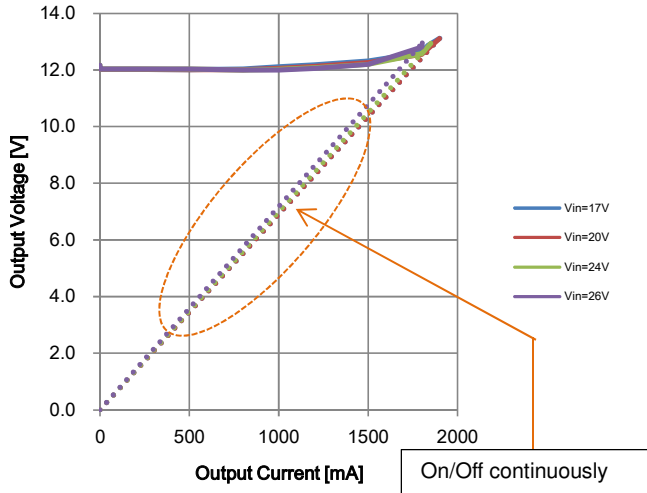

Figure.21 Over Current Limit (Vo : BP5293-12)

Figure.22 UVLO Voltage (Efficiency : BP5293-12)

Table.5 Reliability Test Result

TEST ITEM	STANDARD	TEST CONDITION	n (pcs)	pn (pcs)
Vibration Test	EIAJ ED4701 A-121 Condition A	10 ~ 55Hz, 1.5mm, X-Y-Z Direction Each 2h	5 pcs	0 pcs
Temp Cycle Test	EIAJ ED4701 B-131	Tstg(MIN) ~ Ambient Temp ~ Tstg(MAX), 3000cycle 30min 10min 30min	22 pcs	0 pcs
Temp Humidity Bias Test	EIAJ ED4701 B-122 Condition B	85°C, 85%RH, Voltage Supply 3000h	22 pcs	0 pcs
Electro Static Discharge HBM	EIAJ ED4701-304	C=100pF, R=1.5kΩ, 3times, ±2000V	5 pcs	0 pcs
Electro Static Discharge MM	EIAJ ED4701-304	C=200pF, R=0kΩ, 3times, ±200V	5 pcs	0 pcs

● Power Dissipation

The maximum current must be delating for the ambient temperature.

Please make design keeping the below condition

1. The ambient temperature of the module keeps the operating condition range(T_{opr})
2. The power loss has enough margins within the power dissipation curve
3. The surface temperature is higher than 105°C (T_{cmax})

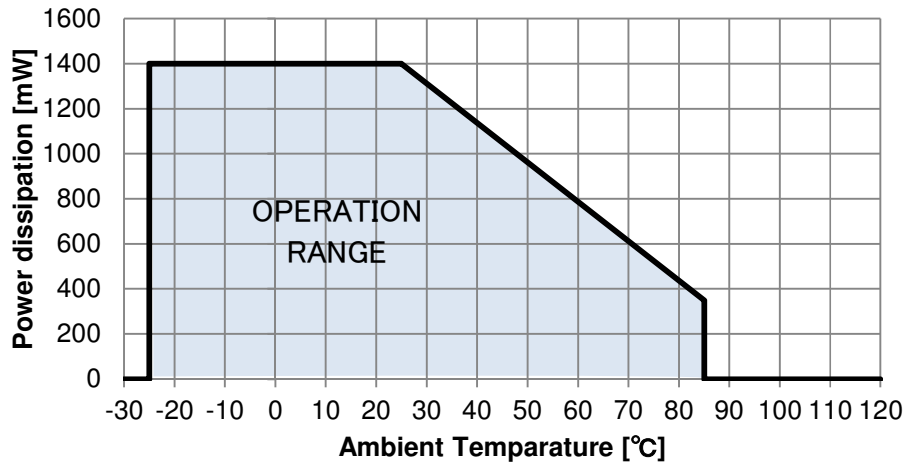

Figure.23 Power dissipation

The surface temperature indicated below line keeps below for allowable maximum surface temperature. If the module condition which its surface temperature is higher than 105°C , the reliability of the module may be compromised.

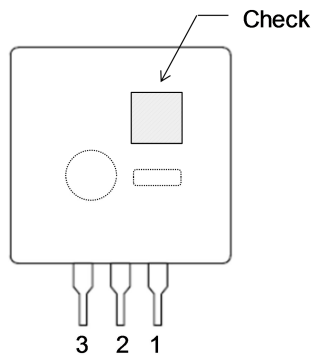

Figure.24 Part of the max heating

● Derating curve

If these power loss condition is satisfied, the derating curve is below graph. The maximum output current is 1000mA. Don't use over this.

• BP5293-33

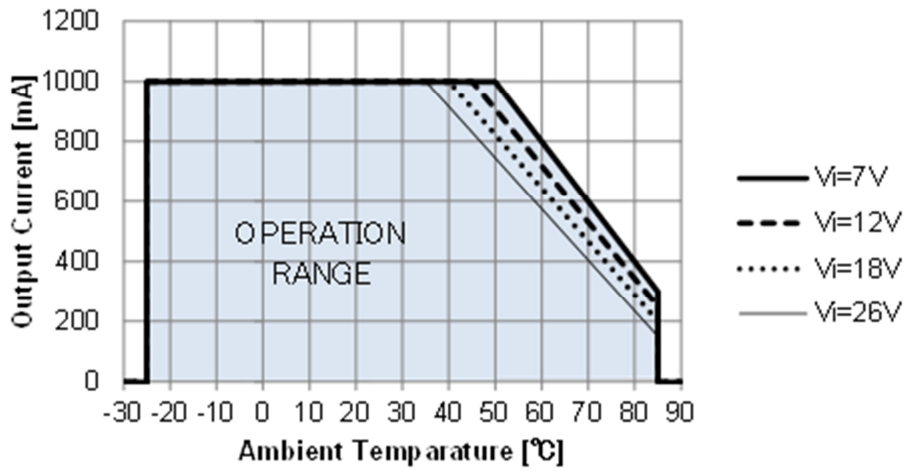

Figure.25 Derating curve (BP5293-33)

• BP5293-50

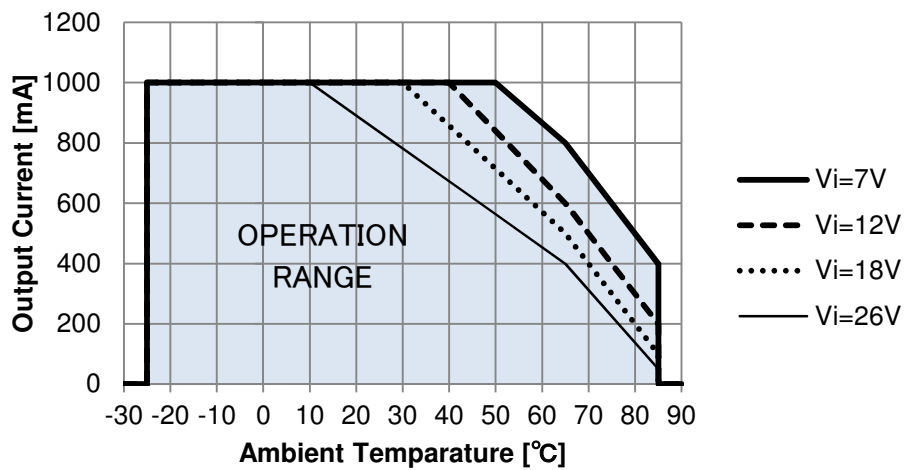

Figure.26 Derating curve (BP5293-50)

• BP5293-12

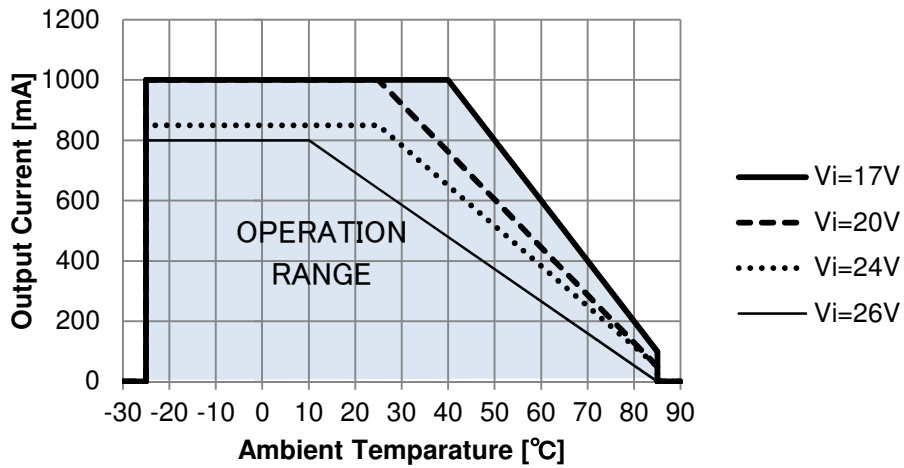

Figure.27 Derating curve (BP5293-12)

If the output current is duty;50%, the derating curve is below graph. The maximum output current is 1000mA. Don't use over this.

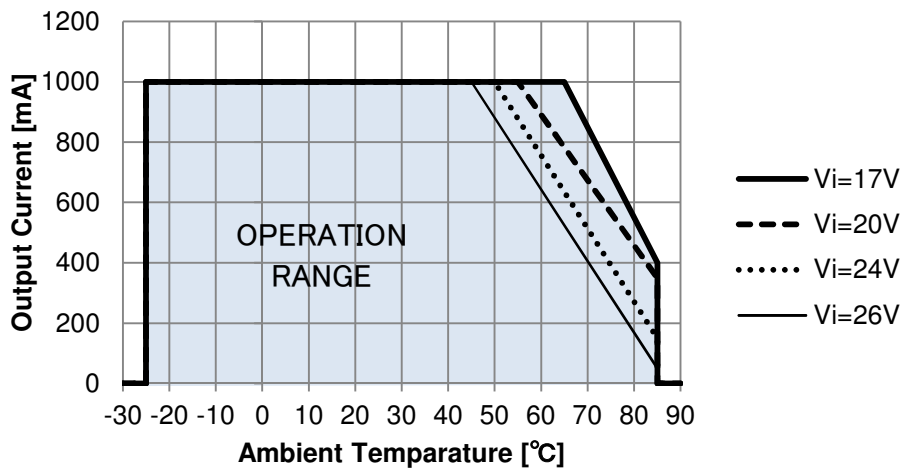

Figure.27-2 Derating curve Duty:50% (BP5293-12)

•Application parts

Recommend adding input or output capacitor as necessary between Input (VIN-GND) and Output (VOUT-GND), though built in capacitor.

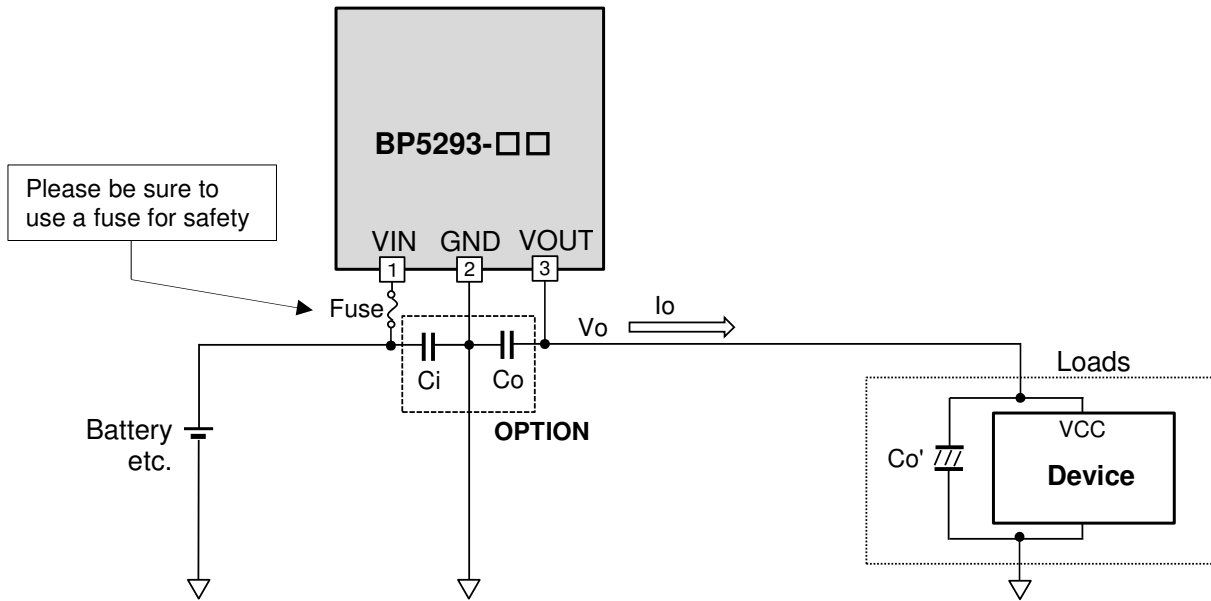

Figure.28 Recommended Circuit

1.) Input Capacitor

In below the case, add input capacitor (Ci) with a low ESR.

- Un-stable because of high ripple input voltage
- Un-stable output because of input voltage dropped when suddenly load changing

If the impedance from power supply to BP5293 is large like the following figure, the DC/DC convertor is not moved exactly. In that case, please add input capacitor (Ci).

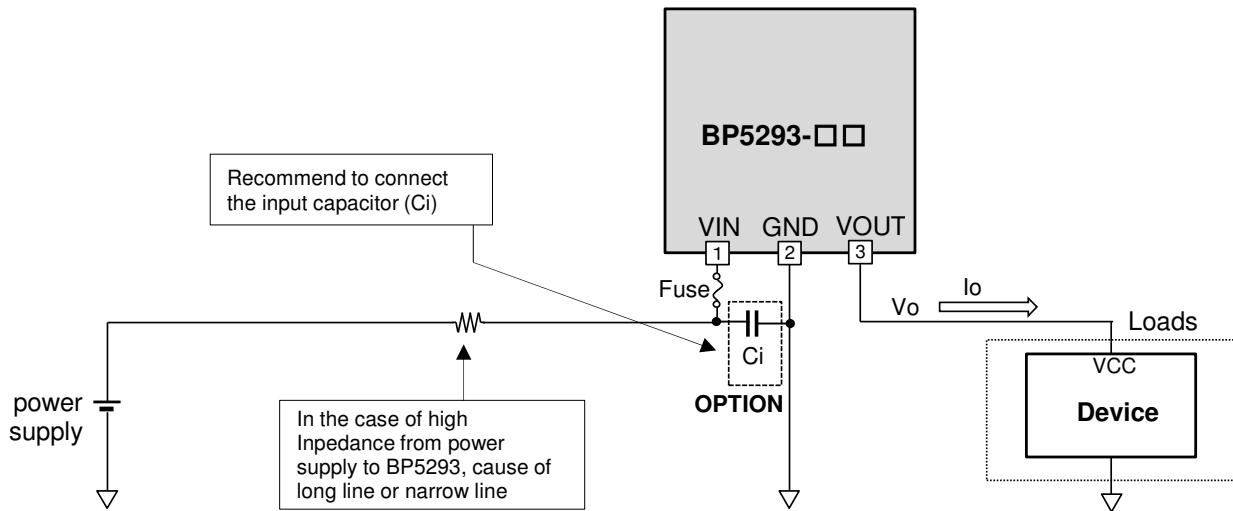

Figure.29 example if the input capacitor is necessary

2.) Output Capacitor

In below the case, add output capacitor (Co) with a low ESR.

- High ripple voltage
- large changing output voltage, when suddenly load changing
- Un-stable output voltage unusually

If output capacitor Co' of the big capacity is connected and the VOUT voltage rise up (the time of soft-start mode), it's a load electric current in, rising of a VOUT voltage become late. Because of an over-current limiter functions by the electric current and the load electric current charged to an output capacitor.

When rising of a VOUT voltage become late, the short-circuit protection sometimes moves. In that case, it isn't normally output any more. Please confirm that input current is less than 1.9A so that an over-current limiter doesn't function.

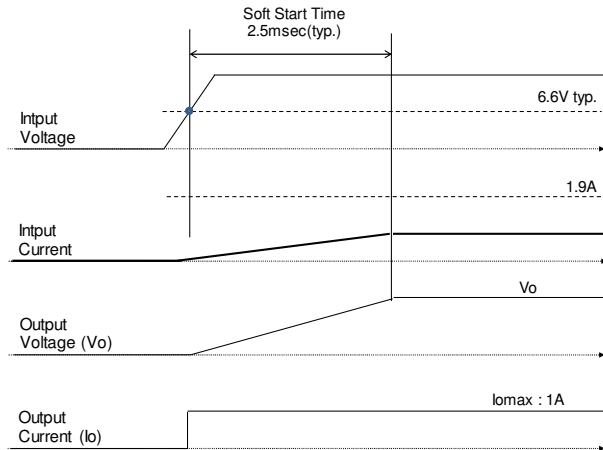

Figure.30-1 normally start waveform if Co' is small

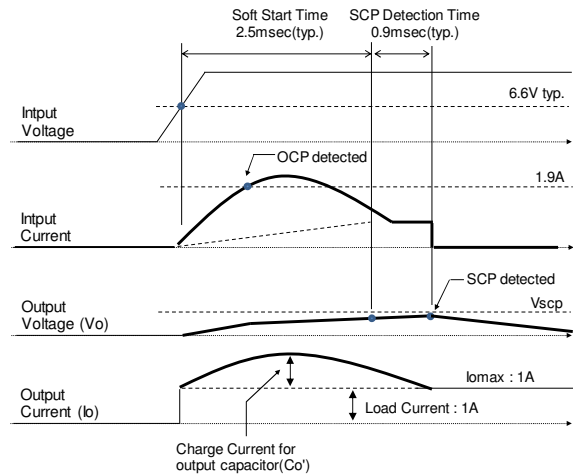

Figure.30-2 abnormal start waveform if Co' is large

If a large Co' is used, while charging to output capacitor, need to reduce load current. And after decrease charge current to output capacitor, following load current. It is prevent current limiter, and it's ordinarily possible to move.

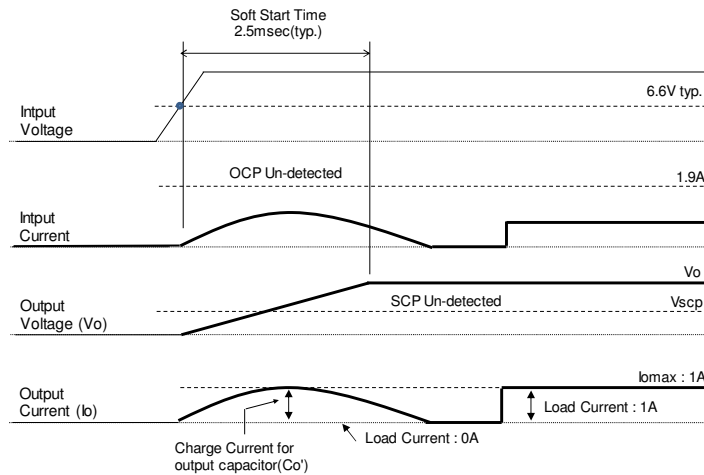

Figure.30-3 Recommended waveform if Co' is big value

3.) Fuse

Please design safely with fail-safe design not to occur danger or damage, if module is broken by any chance. Connect the "Fuse" adapted specification of input current for protecting continuous over current.

If VIN-GND is shorted accidentally, VOUT terminal may be supplied over voltage. If it's supplied over voltage over 26V, VOUT terminal is broken, and if 3A over current continuously, the module is heat, then smoke or ignition. Please connect the "Fuse" 3A below.

•Dimensions

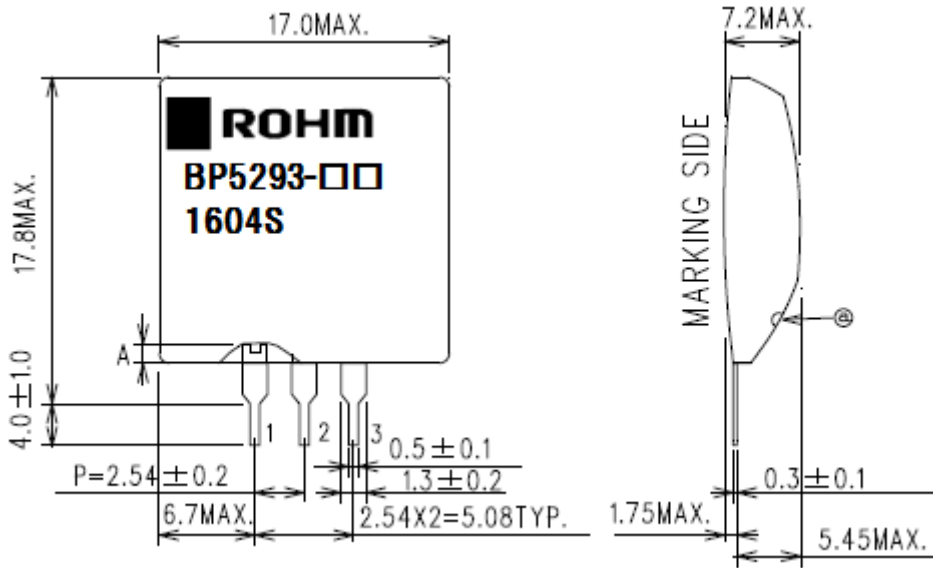

Fig.31 Dimensions

- The external inspection standard is assumed to be a ROHM standard.
- Burr is not covered in above dimension value or tolerance.
- The dimension value without tolerance is a design value. (A=1.2mmMAX)

Marking

■	Pin No.1 Mark
ROHM	Trade Mark
BP5293-□□	Type name
1604*	Production Lot Number
	04th week of 2016
	S:ROHM DALIAN

•Structure

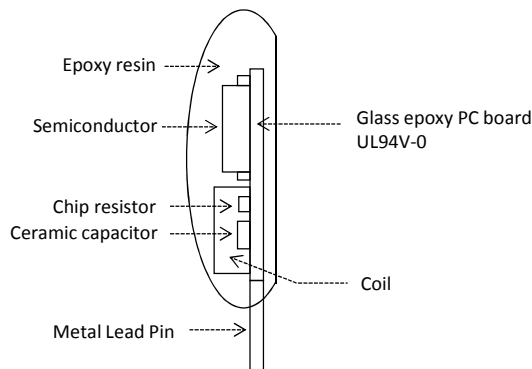

Fig.32 Structure

- Soldering condition

Flow soldering	260°C	within 10sec
Manual soldering	380°C	within 3sec
- Recommended land dimensions

Hole diameter	1.2mm
Land diameter	2.2mm (Please do cutting land when the interval of the pin is necessary)

●Packing Specification

48 pieces of modules might be packaged in the packaging tray, and it might be piled up 5steps, and with an empty pack on the top, in principle.
The number of piling might change according to the quantity of delivery without previous notice.
It is necessary to mount by hand.

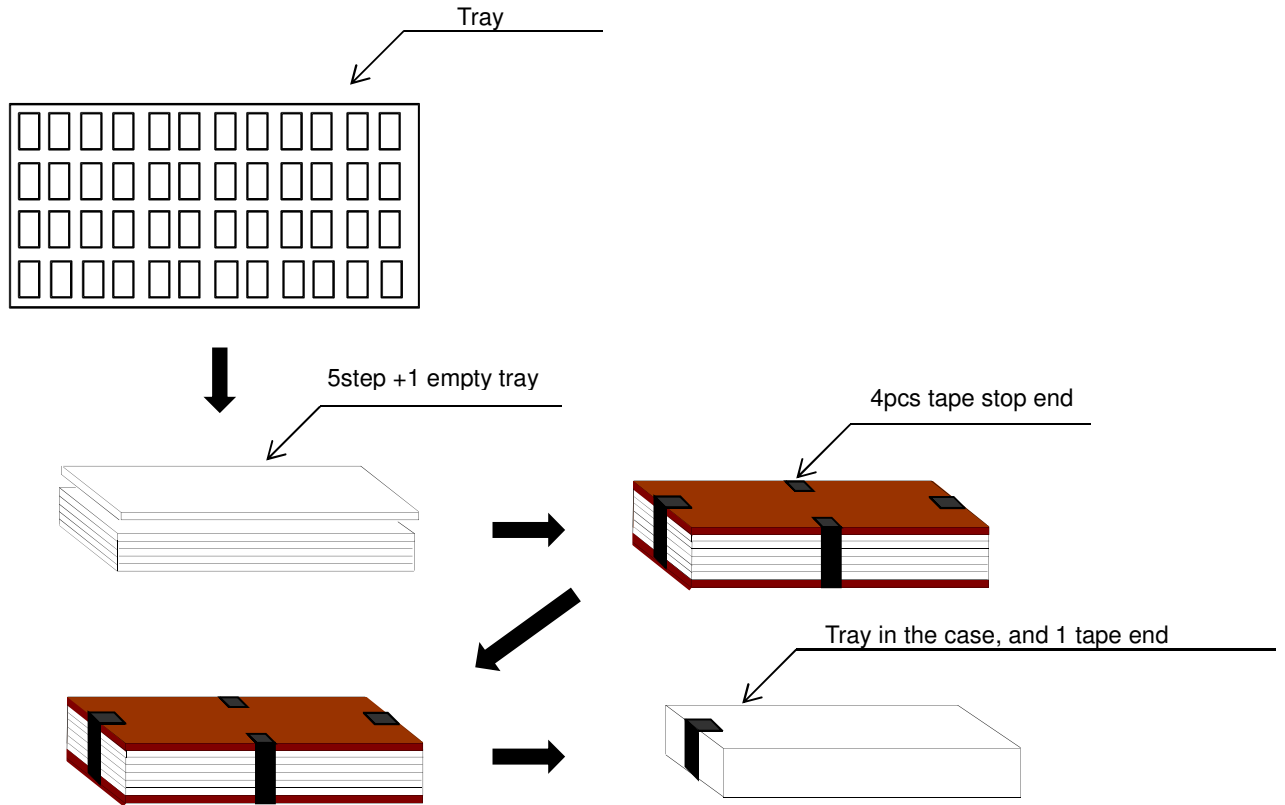

Fig.33 Method of Packing

●Manufacturing Factory

ROHM ELECTRONICS DALIAN CO.,LTD. (CHINA)

•Caution on use

1. Although the power supply is paid much attention for quality control, it might be deteriorated or destructed in case it is used beyond the absolute maximum rated value of applied voltage and the operating temperature range. When designing, it should be used in a guarantee range in any case. It might get damaged if used beyond the absolute maximum value of applied voltage and the operating temperature range. In case of damage, the applied mode such as short mode and open mode cannot be specified, therefore please take physical safety measures including the fuse when the special mode which exceeds the absolute maximum rated value is assumed.
2. The GND terminal should be set at the minimum electric potential in any operating conditions.
3. Please design the heat with enough allowance considering derating in the actual use state.
4. The power supply may be damaged because of the excessive stress on the substrate When the lead pin is bent. Please use the lead pin without bending it.
5. At the time of starting the power supply, please set the output light loaded. The power supply line noise and the voltage drop occurred by the motion electric current should be within the hysteresis width of UVLO. When noises more than hysteresis width are input, I may cause malfunction.
6. The power supply is not designed for vehicle installation, military use and equipment affect human life, please do not use it for these purposes. In case used for the said purposes, we do not take any responsibility for the matters not meeting the requirements.
7. The operating temperature range guarantees the function of the power supply, and is not to guarantee the life of it in the range. Since the life of the power supply is subject to derating in accordance with the usage environment such as applied voltage, ambient temperature, and the humidity, please perform the equipment design considering derating.

•Notice

This document may not be reprinted or reproduced, in whole or in part, without prior written consent of ROHM.
This document is reference document. Please check the formal specification by requesting other document.