

# IRLML2402

HEXFET® Power MOSFET

- Generation V Technology
- Ultra Low On-Resistance
- N-Channel MOSFET
- SOT-23 Footprint
- Low Profile (<1.1mm)
- Available in Tape and Reel
- Fast Switching

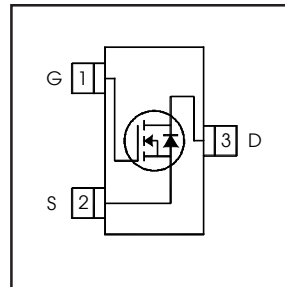

$V_{DSS} = 20V$
$R_{DS(on)} = 0.25\Omega$

## Description

Fifth Generation HEXFETs from International Rectifier utilize advanced processing techniques to achieve extremely low on-resistance per silicon area. This benefit, combined with the fast switching speed and ruggedized device design that HEXFET Power MOSFETs are well known for, provides the designer with an extremely efficient and reliable device for use in a wide variety of applications.

A customized leadframe has been incorporated into the standard SOT-23 package to produce a HEXFET Power MOSFET with the industry's smallest footprint. This package, dubbed the Micro3, is ideal for applications where printed circuit board space is at a premium. The low profile (<1.1mm) of the Micro3 allows it to fit easily into extremely thin application environments such as portable electronics and PCMCIA cards.

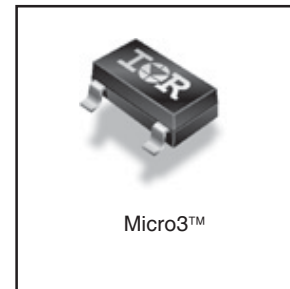

## Absolute Maximum Ratings

	Parameter	Max.	Units
$I_D @ T_A = 25^\circ C$	Continuous Drain Current, $V_{GS} @ 4.5V$	1.2	A
$I_D @ T_A = 70^\circ C$	Continuous Drain Current, $V_{GS} @ 4.5V$	0.95	
$I_{DM}$	Pulsed Drain Current ①	7.4	
$P_D @ T_A = 25^\circ C$	Power Dissipation	540	mW
	Linear Derating Factor	4.3	mW/°C
$V_{GS}$	Gate-to-Source Voltage	$\pm 12$	V
$dv/dt$	Peak Diode Recovery $dv/dt$ ②	5.0	V/ns
$T_J, T_{STG}$	Junction and Storage Temperature Range	-55 to + 150	°C

## Thermal Resistance

	Parameter	Typ.	Max.	Units
$R_{\theta JA}$	Maximum Junction-to-Ambient ④	—	230	°C/W

## Electrical Characteristics @ T<sub>J</sub> = 25°C (unless otherwise specified)

	Parameter	Min.	Typ.	Max.	Units	Conditions
V <sub>(BR)DSS</sub>	Drain-to-Source Breakdown Voltage	20	—	—	V	V <sub>GS</sub> = 0V, I <sub>D</sub> = 250μA
ΔV <sub>(BR)DSS</sub> /ΔT <sub>J</sub>	Breakdown Voltage Temp. Coefficient	—	0.024	—	V/°C	Reference to 25°C, I <sub>D</sub> = 1mA
R <sub>DS(on)</sub>	Static Drain-to-Source On-Resistance	—	—	0.25	Ω	V <sub>GS</sub> = 4.5V, I <sub>D</sub> = 0.93A ③
		—	—	0.35		V <sub>GS</sub> = 2.7V, I <sub>D</sub> = 0.47A ③
V <sub>GS(th)</sub>	Gate Threshold Voltage	0.70	—	—	V	V <sub>DS</sub> = V <sub>GS</sub> , I <sub>D</sub> = 250μA
g <sub>fs</sub>	Forward Transconductance	1.3	—	—	S	V <sub>DS</sub> = 10V, I <sub>D</sub> = 0.47A
I <sub>DSS</sub>	Drain-to-Source Leakage Current	—	—	1.0	μA	V <sub>DS</sub> = 16V, V <sub>GS</sub> = 0V
		—	—	25		V <sub>DS</sub> = 16V, V <sub>GS</sub> = 0V, T <sub>J</sub> = 125°C
I <sub>GSS</sub>	Gate-to-Source Forward Leakage	—	—	-100	nA	V <sub>GS</sub> = -12V
	Gate-to-Source Reverse Leakage	—	—	100		V <sub>GS</sub> = 12V
Q <sub>g</sub>	Total Gate Charge	—	2.6	3.9	nC	I <sub>D</sub> = 0.93A
Q <sub>gs</sub>	Gate-to-Source Charge	—	0.41	0.62		V <sub>DS</sub> = 16V
Q <sub>gd</sub>	Gate-to-Drain ("Miller") Charge	—	1.1	1.7		V <sub>GS</sub> = 4.5V, See Fig. 6 and 9 ③
t <sub>d(on)</sub>	Turn-On Delay Time	—	2.5	—	ns	V <sub>DD</sub> = 10V
t <sub>r</sub>	Rise Time	—	9.5	—		I <sub>D</sub> = 0.93A
t <sub>d(off)</sub>	Turn-Off Delay Time	—	9.7	—		R <sub>G</sub> = 6.2Ω
t <sub>f</sub>	Fall Time	—	4.8	—		R <sub>D</sub> = 11Ω, See Fig. 10 ③
C <sub>iss</sub>	Input Capacitance	—	110	—	pF	V <sub>GS</sub> = 0V
C <sub>oss</sub>	Output Capacitance	—	51	—		V <sub>DS</sub> = 15V
C <sub>rss</sub>	Reverse Transfer Capacitance	—	25	—		f = 1.0MHz, See Fig. 5

## Source-Drain Ratings and Characteristics

	Parameter	Min.	Typ.	Max.	Units	Conditions
I <sub>S</sub>	Continuous Source Current (Body Diode)	—	—	0.54	A	MOSFET symbol showing the integral reverse p-n junction diode.
I <sub>SM</sub>	Pulsed Source Current (Body Diode) ①	—	—	7.4		
V <sub>SD</sub>	Diode Forward Voltage	—	—	1.2	V	T <sub>J</sub> = 25°C, I <sub>S</sub> = 0.93A, V <sub>GS</sub> = 0V ③
t <sub>rr</sub>	Reverse Recovery Time	—	25	38	ns	T <sub>J</sub> = 25°C, I <sub>F</sub> = 0.93A
Q <sub>rr</sub>	Reverse Recovery Charge	—	16	24	nC	di/dt = 100A/μs ③

### Notes:

- ① Repetitive rating; pulse width limited by max. junction temperature. ( See fig. 11 )
- ② I<sub>SD</sub> ≤ 0.93A, di/dt ≤ 90A/μs, V<sub>DD</sub> ≤ V<sub>(BR)DSS</sub>, T<sub>J</sub> ≤ 150°C
- ③ Pulse width ≤ 300μs; duty cycle ≤ 2%.
- ④ Surface mounted on FR-4 board, t ≤ 5sec.

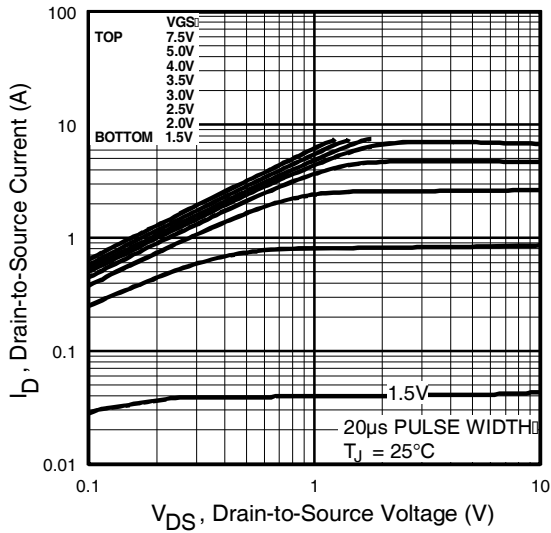

Fig 1. Typical Output Characteristics

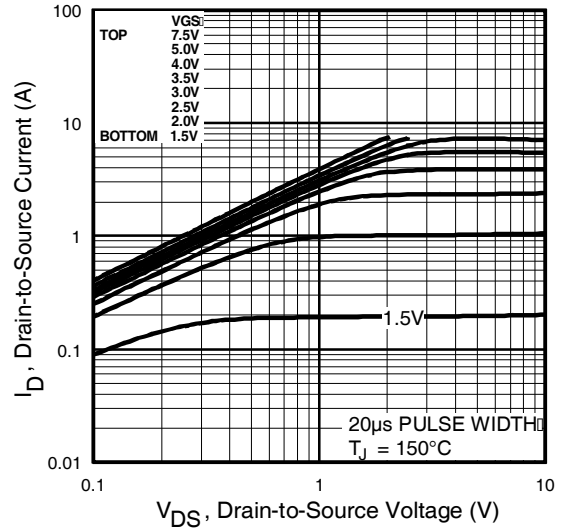

Fig 2. Typical Output Characteristics

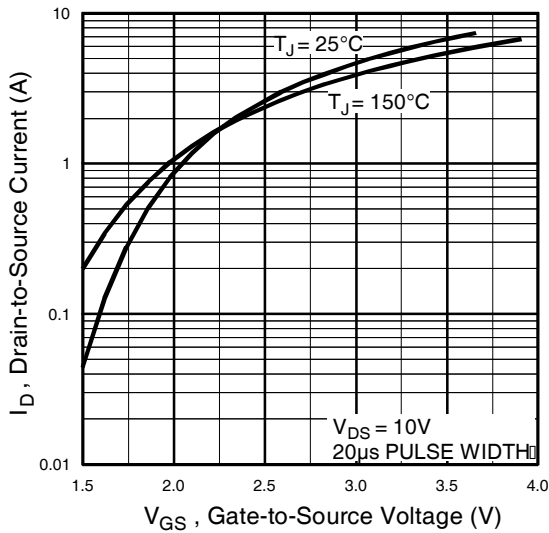

Fig 3. Typical Transfer Characteristics

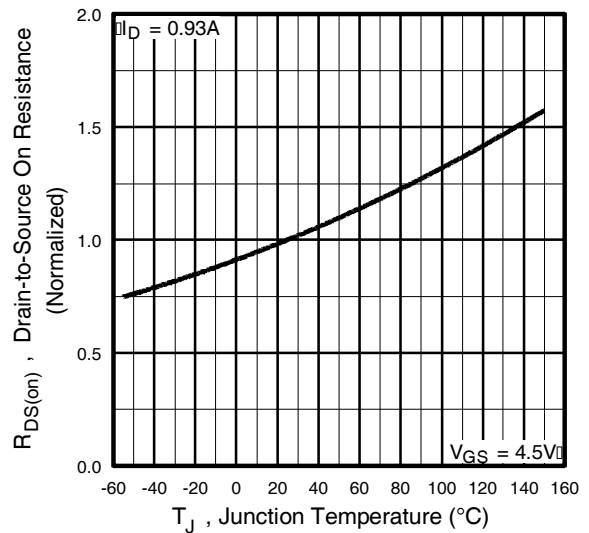
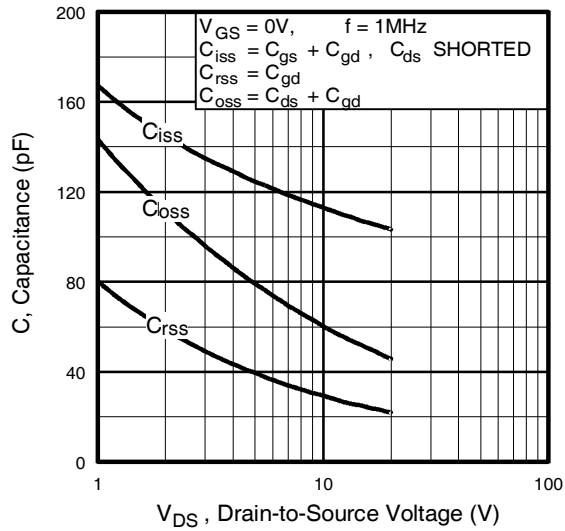
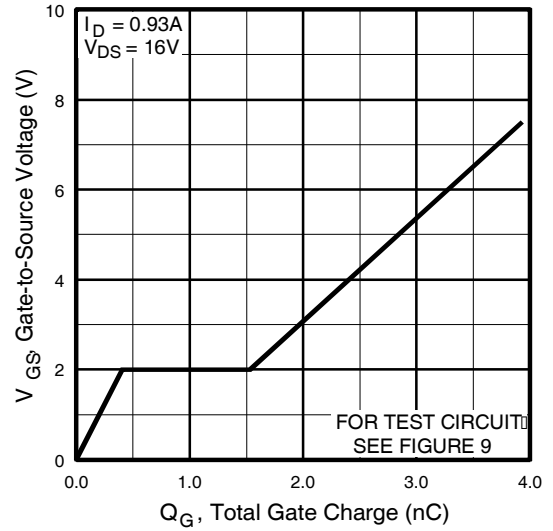

Fig 4. Normalized On-Resistance Vs. Temperature



**Fig 5.** Typical Capacitance Vs. Drain-to-Source Voltage



**Fig 6.** Typical Gate Charge Vs. Gate-to-Source Voltage

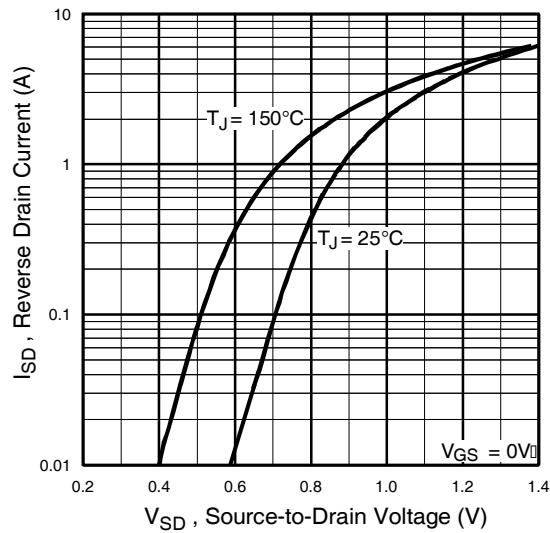

**Fig 7.** Typical Source-Drain Diode Forward Voltage

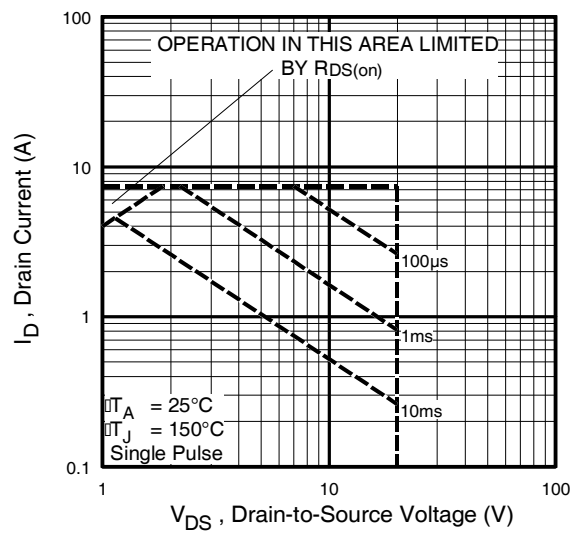

**Fig 8.** Maximum Safe Operating Area

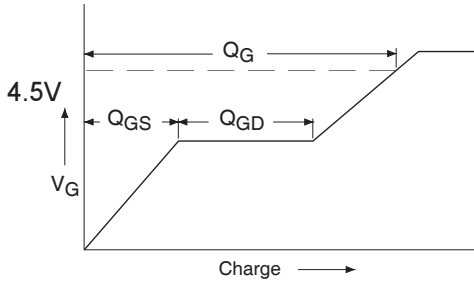

Fig 9a. Basic Gate Charge Waveform

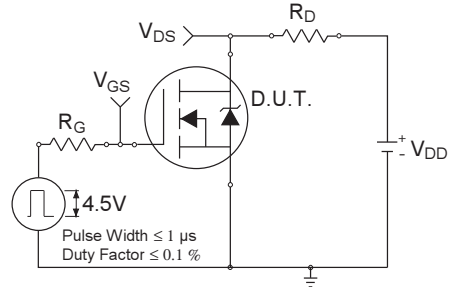

Fig 10a. Switching Time Test Circuit

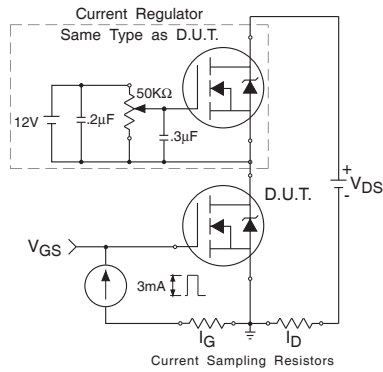

Fig 9b. Gate Charge Test Circuit

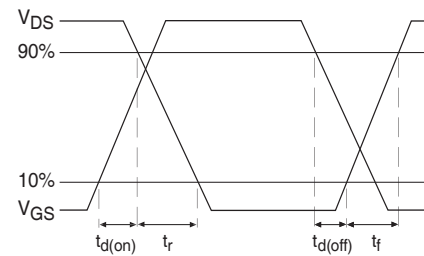

Fig 10b. Switching Time Waveforms

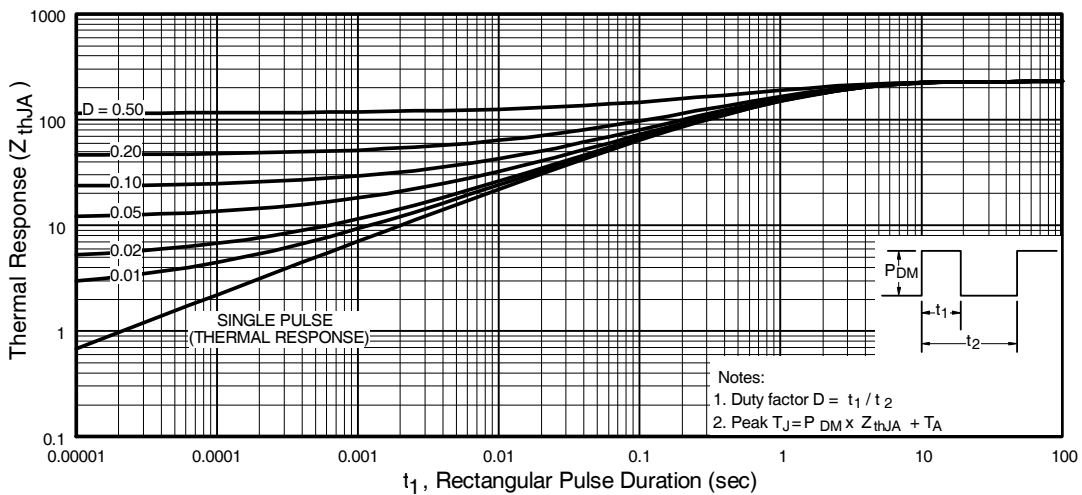
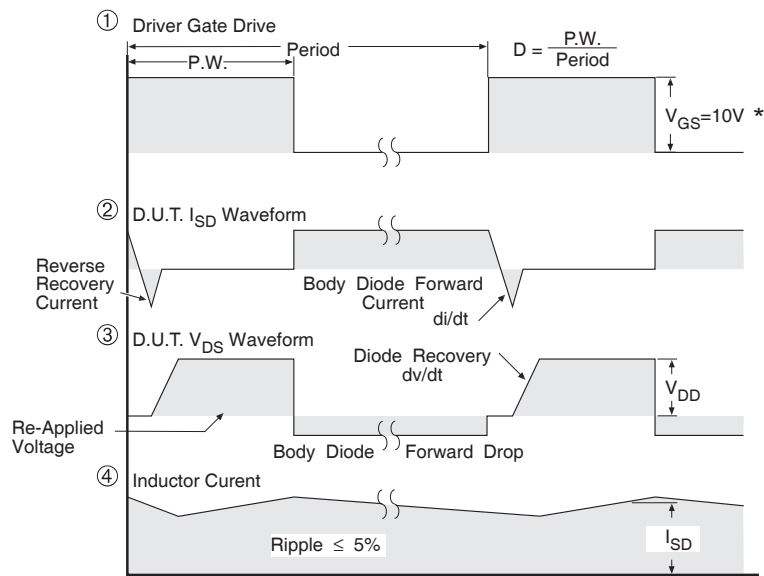
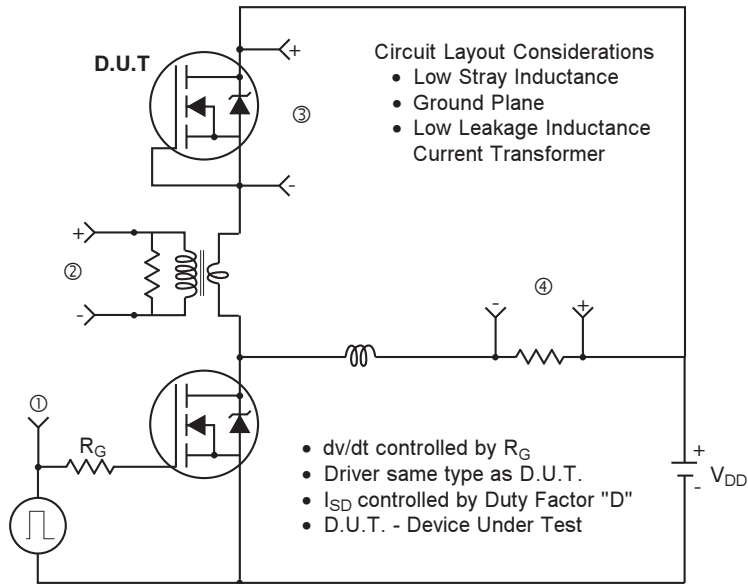

Fig 11. Maximum Effective Transient Thermal Impedance, Junction-to-Ambient

Peak Diode Recovery dv/dt Test Circuit



\*  $V_{GS} = 5V$  for Logic Level Devices

Fig 12. For N-Channel HEXFETS

## Micro3 (SOT-23) (Lead-Free) Package Outline

Dimensions are shown in millimeters (inches)

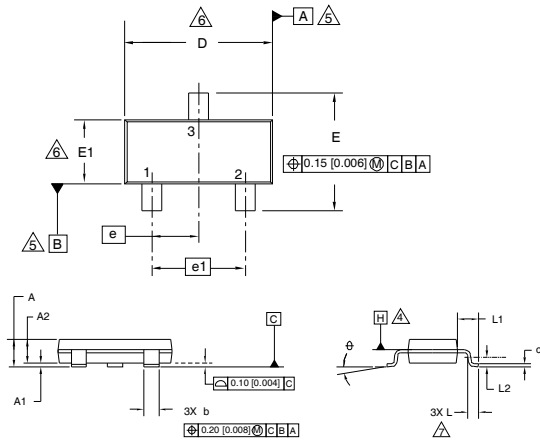

SYMBOL	DIMENSIONS			
	MILLIMETERS		INCHES	
	MIN	MAX	MIN	MAX
A	0.89	1.12	0.035	0.044
A1	0.01	0.10	0.0004	0.004
A2	0.88	1.02	0.035	0.040
b	0.30	0.50	0.012	0.020
c	0.08	0.20	0.003	0.008
D	2.80	3.04	0.110	0.120
E	2.10	2.64	0.083	0.104
E1	1.20	1.40	0.047	0.055
e	0.95	BSC	0.037	BSC
e1	1.90	BSC	0.075	BSC
L	0.40	0.60	0.016	0.024
L1	0.54	REF	0.021	REF
L2	0.25	BSC	0.010	BSC
⌀	0	8	0	8

### Recommended Footprint

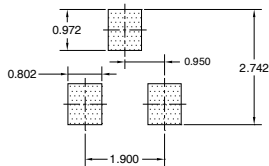

### NOTES:

- DIMENSIONING & TOLERANCING PER ANSI Y14.5M-1994
- DIMENSIONS ARE SHOWN IN MILLIMETERS (INCHES).
- CONTROLLING DIMENSION: MILLIMETER.
- DATUM PLANE H IS LOCATED AT THE MOLD PARTING LINE.
- DATUM A AND B TO BE DETERMINED AT DATUM PLANE H.
- DIMENSIONS D AND E1 ARE MEASURED AT DATUM PLANE H. DIMENSIONS DOES NOT INCLUDE MOLD PROTRUSIONS OR INTERLEAD FLASH. MOLD PROTRUSIONS OR INTERLEAD FLASH SHALL NOT EXCEED 0.25 MM (0.010 INCH) PER SIDE.
- DIMENSION L IS THE LEAD LENGTH FOR SOLDERING TO A SUBSTRATE.
- OUTLINE CONFORMS TO JEDEC OUTLINE TO-236 AB.

## Micro3 (SOT-23 / TO-236AB) Part Marking Information

### Micro3 / SOT-23 Package Marking

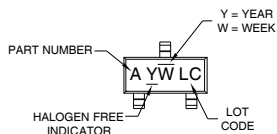

### PART NUMBER CODE REFERENCE:

- A = IRLML2402
- B = IRLML2803
- C = IRLML2402
- D = IRLML5103
- E = IRLML6402
- F = IRLML6401
- G = IRLML2502
- H = IRLML5203

Note: A line above the work week (as shown here) indicates Lead-free

W = (1-26) IF PRECEDED BY LAST DIGIT OF CALENDAR YEAR

YEAR	Y	WORK WEEK	W
2001	1	01	A
2002	2	02	B
2003	3	03	C
2004	4	04	D
2005	5		
2006	6		
2007	7		
2008	8		
2009	9		
2010	0	24	X
		25	Y
		26	Z

W = (27-52) IF PRECEDED BY A LETTER

YEAR	Y	WORK WEEK	W
2001	A	27	A
2002	B	28	B
2003	C	29	C
2004	D	30	D
2005	E		
2006	F		
2007	G		
2008	H		
2009	J		
2010	K	50	X
		51	Y
		52	Z

Note: For the most current drawing please refer to IR website at <http://www.irf.com/package>

# IRLML2402

## Micro3™ Tape & Reel Information

Dimensions are shown in millimeters (inches)

International  
**IR** Rectifier

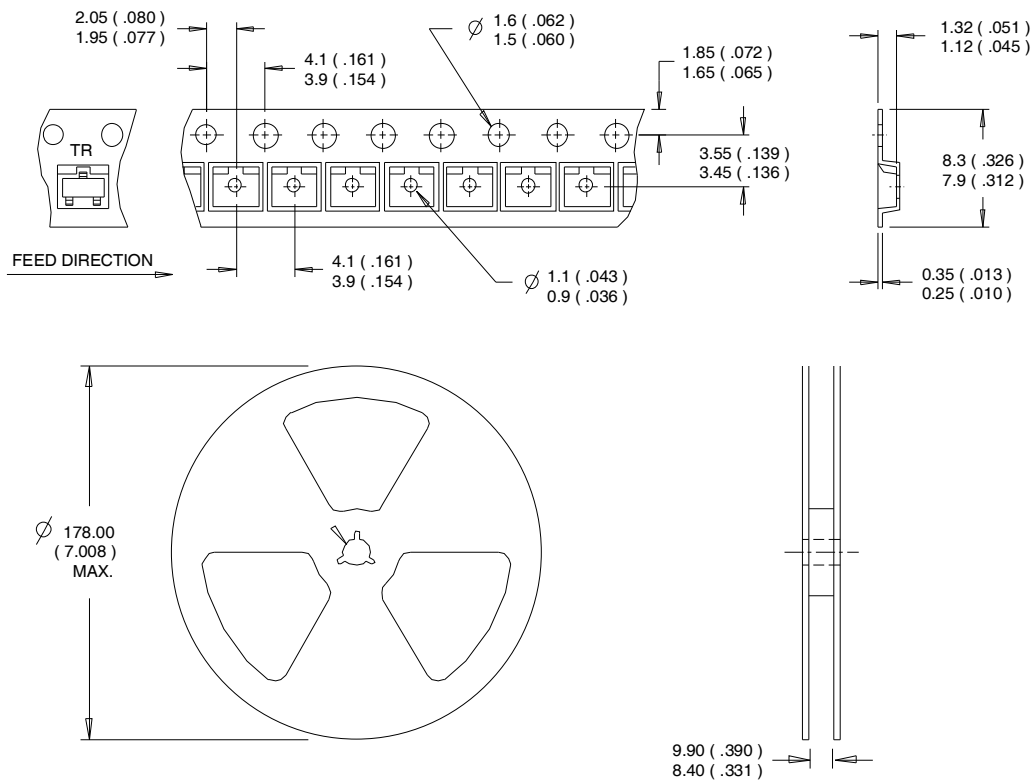

- NOTES:  
1. CONTROLLING DIMENSION : MILLIMETER.  
2. OUTLINE CONFORMS TO EIA-481 & EIA-541.

**Note:** For the most current drawing please refer to IR website at <http://www.irf.com/package>

Data and specifications subject to change without notice.

International  
**IR** Rectifier

**IR WORLD HEADQUARTERS:** 101N.Sepulveda Blvd, El Segundo, California 90245, USA Tel: (310) 252-7105  
TAC Fax: (310) 252-7903

Visit us at [www.irf.com](http://www.irf.com) for sales contact information. 12/2011